



International
Labour
Organization



WISCON

Work Improvement For Small Construction Sites

Action manual for improving safety,
health and working conditions
on small construction sites,
designed for employers,
supervisors and workers





WISCON

Work Improvement For Small Construction Sites

Action manual for improving safety,
health and working conditions
on small construction sites,
designed for employers,
supervisors and workers

Edited by

Tsuyoshi Kawakami

Copyright © International Labour Organization 2021

First published year: 2021

Publications of the International Labour Office enjoy copyright under Protocol 2 of the Universal Copyright Convention. Nevertheless, short excerpts from them may be reproduced without authorization, on condition that the source is indicated. For rights of reproduction or translation, application should be made to ILO Publishing (Rights and Licensing), International Labour Office, CH-1211 Geneva 22, Switzerland, or by email: rights@ilo.org. The International Labour Office welcomes such applications.

Libraries, institutions and other users registered with a reproduction rights organization may make copies in accordance with the licences issued to them for this purpose. Visit www.ifrro.org to find the reproduction rights organization in your country.

ISBN: 9789220344613 (Print)

ISBN: 9789220344620 (Web PDF)

The designations employed in ILO publications, which are in conformity with United Nations practice, and the presentation of material therein do not imply the expression of any opinion whatsoever on the part of the International Labour Office concerning the legal status of any country, area or territory or of its authorities, or concerning the delimitation of its frontiers.

The responsibility for opinions expressed in signed articles, studies and other contributions rests solely with their authors, and publication does not constitute an endorsement by the International Labour Office of the opinions expressed in them.

Reference to names of firms and commercial products and processes does not imply their endorsement by the International Labour Office, and any failure to mention a particular firm, commercial product or process is not a sign of disapproval.

Information on ILO publications and digital products can be found at: www.ilo.org/publns.

Cover photo: © ILO

Illustration: © ILO

Printed in India

Preface

Construction is one of the largest industrial sectors in India and other countries in South Asia. It includes numerous small construction businesses for building houses, shops and other infrastructure. Many workers including young workers, women workers and migrant workers find their jobs in this sector. Most small construction businesses belong to the informal economy and do not receive labour inspection and Occupational Safety and Health (OSH) services. Workers in small construction sites face significant OSH risks, such as fall from height, being hurt by falling objects, injuries due to lifting or carrying heavy materials, exposure to dust and hot working environment, handling hazardous chemicals, or unsafe use of machines and electricity. Most of the accidents are not reported to the competent authorities. Workers, especially women workers often suffer from poor sanitation facilities and housing conditions. This situation does not only have a direct impact on the workers' health but also on the work output, quality and productivity, holding back the performance and growth potential of the businesses.

The WISCON (Work Improvements in Small Construction Sites) manual is designed to help employers and workers in small construction sites create safe and healthy workplaces. The improvement ideas shown in this manual are also useful for improving productivity and efficiency in small construction sites and can support the growth and sustainability of their businesses. The emphasis of the manual is to provide easy-to-apply and low-cost solutions using locally available materials and ideas. For this purpose, many clear-cut illustrations showing practical examples are presented. The manual also intends to promote constructive dialogue and collaborative action between employers and workers for implementing improvements.

The WISCON manual is based on the ILO's rich experiences in participatory training methodologies for improving safety and health of small enterprises, known as WISE (Work Improvement in Small Enterprises). The first WISE manual "Higher productivity and a better place to work - Practical ideas for owners and managers of small and medium-sized industrial enterprises", published in 1988 established the participatory, action-oriented training methodologies focusing on low-cost solutions. The first WISCON training methodologies became available in Thailand in 2003, actively applied in many countries in Asia and Africa. In 2020, India carried out the first WISCON training using this manual with the support of Department of Factories and Boilers and Labour Commissionerate under Department of Labour and Skills, Government of Kerala. The ILO Project on "Post Disaster Livelihood Recovery and Rehabilitation in Kerala" funded by the Government of Japan provided the financial assistance.

Participating government officials, workers and employers were able to identify many practical solutions for improving safety and health of their construction sites.

Many specialists contributed to the development of the WISCON manual. Dr. Tsuyoshi Kawakami, Senior Specialist on Occupational Safety and Health and Labour Inspection, ILO Decent Work Technical Support Team for South Asia, New Delhi reviewed and compiled the past experiences and completed drafting. Mr. Andrew Christian, Technical Specialist on Labour Inspection and Occupational Safety and Health, LABADMINOSH, ILO, Geneva, reviewed the draft and assisted finalizing all the text and illustrations. Ms Ruchira Chandra, Ms Kanagarani Selvakumar and Ms Jyoti Gahlot provided their programming and administrative support in the course of the manual development.

I also would like to acknowledge the professional contributions received from international experts and ILO colleagues who assisted completing the text and illustrations, especially Mr Yothin Thandunkul, Dr Ton That Khai, Ms Ingrid Christensen and Dr Kazutaka Kogi.

I sincerely hope that the manual will help many workers and employers in small construction sites to improve their safety, health and working conditions for better business performance.

Dagmar Walter

Director

ILO Decent Work Technical Support Team for South Asia
and Country Office for India

Table of contents

| | |
|--|----|
| WISCON Action Checklist | 5 |
| Chapter 1 : Construction Site Planning and Layout (Checkpoints 1 – 4) | 15 |
| Chapter 2 : Work at height (Checkpoints 5 –11) | 25 |
| Chapter 3 : Safe use of machinery and electricity (Checkpoints 12 – 15) | 41 |
| Chapter 4 : Materials handling and storage (Checkpoints 16 – 20) | 51 |
| Chapter 5 : Physical environment (Checkpoints 21 – 26) | 63 |
| Chapter 6 : Welfare facilities (Checkpoints 27 – 32) | 77 |
| Chapter 7 : Work organization and training (Checkpoints 33 – 34) | 91 |
| Chapter 8 : Other safe work procedures (Excavation and demolition work) (Checkpoints 35 – 36) | 97 |

WISCON

Work Improvement for Small Construction Sites

Action checklist

for employers, supervisors and workers
on small construction sites



How to use the checklist

1. Define the work area to be checked.
2. Spend a few minutes walking around the work area.
3. Select No or Yes for each action.
 - If the action has been applied or is not needed, mark No.
 - If you propose the action, mark Yes.
4. Mark Priority for urgent actions.
5. Put your suggestions under Remarks.

1. Construction site planning & layout



1. Prepare and regularly update a Safety and Health Plan (SHP).

Do you propose action?

No Yes Priority

Remarks :

.....



2. Organize the site layout to ensure efficient and safe work.

Do you propose action?

No Yes Priority

Remarks :

.....

.....



3. Clear and mark transport passageways and walkways.

Do you propose action?

No Yes Priority

Remarks :

.....

.....



4. Provide unobstructed escape routes for emergencies and for emergency vehicles.

Do you propose action?

No Yes Priority

Remarks :

.....

.....

2. Work at height



5. Build guard-rails to prevent falls from edges and openings on the construction site.

Do you propose action?

No Yes Priority

Remarks :

.....

6. Erect and dismantle scaffolding safely.

Do you propose action?

- No Yes Priority

Remarks :
.....
.....



7. Secure the scaffolding to the building in enough places to prevent scaffold collapse.

Do you propose action?

- No Yes Priority

Remarks :
.....
.....



8. Equip scaffolding with safe platforms, guard-rails and toe boards.

Do you propose action?

- No Yes Priority

Remarks :
.....
.....



9. Secure ladders, even if only used for a short time.

Do you propose action?

- No Yes Priority

Remarks :
.....
.....

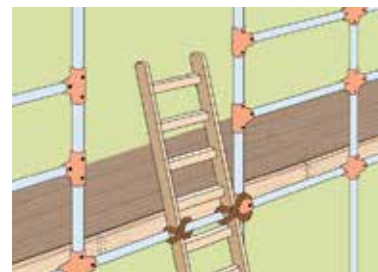

10. Whenever appropriate, install safety nets to complement other systems used to protect against falls.

Do you propose action?

- No Yes Priority

Remarks :
.....
.....





11. When collective protection is not possible, use a safety harness, energy absorbers and lanyards (connecting the harness to the anchor point) to limit the effects of a fall.

Do you propose action?
 No Yes Priority

Remarks :
.....
.....

3. Safe use of machinery and electricity



12. Attach proper guards to prevent contact with the dangerous moving parts of machines.

Do you propose action?
 No Yes Priority

Remarks :
.....
.....



13. Attach easy-to-read labels and signs to critically important objects, written in the language that workers at the site can understand.

Do you propose action?
 No Yes Priority

Remarks :
.....
.....



14. Check the safety of hoists, cranes, and other machines every day before use.

Do you propose action?
 No Yes Priority

Remarks :
.....
.....

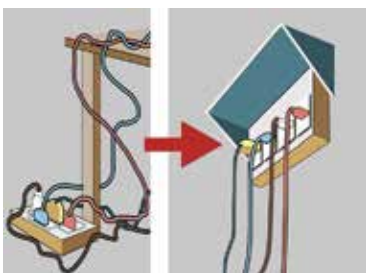

15. Ensure safe wiring connections for supplying electricity to equipment and lights.

Do you propose action?
 No Yes Priority

Remarks :
.....
.....

4. Materials handling and storage

16. Use carts and containers when carrying heavy materials.

Do you propose action?

- No Yes Priority

Remarks :
.....
.....



17. Use hoists or other mechanical means for moving or lifting heavy materials and equipment.

Do you propose action?

- No Yes Priority

Remarks :
.....
.....



18. Provide appropriate places for storing tools and materials.

Do you propose action?

- No Yes Priority

Remarks :
.....
.....



19. Place frequently-used materials, tools and controls within easy reach of workers.

Do you propose action?

- No Yes Priority

Remarks :
.....
.....



20. Limit all weights to be manually handled by a worker to a maximum of 25 kg.

Do you propose action?

- No Yes Priority

Remarks :
.....
.....



5. Physical environment



21. Ensure all workers have adequate lighting to work safely.

Do you propose action?

No Yes Priority

Remarks :
.....
.....



22. Protect workers from heat and cold.

Do you propose action?

No Yes Priority

Remarks :
.....
.....



23. Ensure safe work on rainy days and at night.

Do you propose action?

No Yes Priority

Remarks :
.....
.....

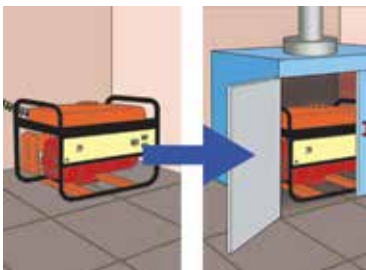

24. Ensure all sources of noise, vibration and dust are enclosed or isolated.

Do you propose action?

No Yes Priority

Remarks :
.....
.....



25. Keep all containers of hazardous chemicals in designated and lockable areas.

Do you propose action?

No Yes Priority

Remarks :
.....
.....

26. Provide personal protective equipment for all workers according to their protection needs.

Do you propose action?

No Yes Priority

Remarks :
.....
.....



6. Welfare facilities

27. Provide safe drinking water that is easily accessible to all workers.

Do you propose action?

No Yes Priority

Remarks :
.....



28. Provide separate, clean male and female toilets, and washing facilities, close to the work area.

Do you propose action?

No Yes Priority

Remarks :
.....
.....



29. Provide workers with meal areas and other welfare facilities.

Do you propose action?

No Yes Priority

Remarks :
.....
.....



30. Provide comfortable accommodation facilities for workers.

Do you propose action?

No Yes Priority

Remarks :
.....
.....





31. Ensure that first-aid facilities are available.

Do you propose action?
 No Yes Priority

Remarks :



32. Promote hygienic practices to prevent infectious diseases.

Do you propose action?
 No Yes Priority

Remarks :

7. Work organization and training



33. Ensure workers have sufficient rest time to recover from fatigue.

Do you propose action?
 No Yes Priority

Remarks :



34. Ensure all workers have training in ways to prevent accidents and diseases.

Do you propose action?
 No Yes Priority

Remarks :

8. Other safe work procedures



35. Work safely in trench excavations.

Do you propose action?
 No Yes Priority

Remarks :

36. Ensure the planned and safe demolition of building and structures.

Do you propose action?

No Yes Priority

Remarks :
.....
.....



Additional checkpoints

37.....

Do you propose action?

No Yes Priority

Remarks :
.....

38.....

Do you propose action?

No Yes Priority

Remarks :
.....
.....

39.....

Do you propose action?

No Yes Priority

Remarks :
.....
.....

40.....

Do you propose action?

No Yes Priority

Remarks :
.....
.....



Chapter 1

Construction Site Planning and Layout

(Checkpoints 1 – 4)

▶ Checkpoint 1

Prepare and regularly update a Safety and Health Plan (SHP).

Benefits

Construction activities follow a schedule. All those working on a construction site need to know the sequence, working methods and resources required to perform each of the project's activities. Providing information on the timeframe of each activity and the total time scheduled for completing the project is vital for ensuring its quality.

This information is also of utmost importance in guaranteeing workers' safety and health. It makes it possible to identify and assess the hazards inherent in each activity, along with the risk prevention measures that should be planned in parallel with the usual planning of any construction project.

The SHP is therefore a document that brings together all the relevant information related to safety and health, which also includes the hazards identified and the risk prevention measures to be implemented to minimize risks to workers.

How to improve

1. Ensure that a SHP has been prepared before construction starts.
2. Before starting any new activity in the schedule, analyse the safety and health risk prevention measures envisaged in the SHP. If they are inadequate for the working method envisaged, update the SHP and implement the new measures.
3. Explain in detail the working method, the risks involved and the risk prevention measures to be implemented to all workers engaged in each activity.

Ways to promote cooperation

Experienced workers are aware of the hazards inherent in their work and often know many of the usual safety and health risk prevention measures. Before starting each activity, discuss the measures envisaged in the SHP with them.

Employers have a duty to inform all workers about the risks to which they may be exposed and to implement all the necessary risk prevention measures to eliminate or minimize them. They have also a duty to provide all necessary means of protection without cost to the workers.

Some more hints

1. When drawing up a SHP for a construction site keep it as simple as possible and limit the contents to those risks relevant to the construction site under consideration. Many of the examples of good measures in this WISCON manual may be incorporated into the SHP, but they may have to be adapted to each construction site.
2. The implementation of collective measures (e.g. guard-rails) should take priority over individual measures (e.g. use of harnesses).
3. Among the collective measures, priority should be given to those that eliminate the hazards at source. Those measures that limit the effects of the risks (but do not eliminate them) should be used mainly as complementary measures.

Points to remember

A safety and health plan (SHP) brings together all relevant information on hazards and risk prevention measures, making prevention easier and more effective.



Figure 1.1. Each construction site should have a safety and health plan (SHP) bringing together all the relevant information related to safety and health. It should also include the hazards identified and their risk prevention measures. The content of this WISCON manual may help with the preparation of this plan.



Figure 1.2. Before starting each new activity specified in the schedule, invite workers to jointly analyse the risk prevention measures contained in the SHP. If they are inadequate for the working method envisaged, update the SHP and implement the new measures.

▶ Checkpoint 2

Organize the site layout to ensure efficient and safe work.

Benefits

All construction sites of any size need a well-organized site layout. This is important to increase productivity and, above all, to improve workers' safety and health at the workplace.

Designing a site layout is the employer's responsibility. The layout should aim to maximize work efficiency by promoting productivity and creating good working conditions to attract and retain workers.

The requirements for a site layout are contingent upon many factors – for instance the site's type, size and location. They may call for a number of temporary operational and social facilities, such as: fencing; site offices; storage for materials and tools; areas for the preparation of concrete-related materials (rebar, forms, concrete); temporary electrical supply, water supply and sanitation; welfare-related facilities (e.g. accommodation, eating places, toilets, showers and cloakrooms).

How to improve

1. Design a site layout in three stages:
 - (i) identify the temporary facilities needed;
 - (ii) size and, where applicable, design each of these facilities; and
 - (iii) plan the location of these facilities within the boundaries of the site, taking into account the existing restrictions on site and optimizing the operational efficiency of the site works.
2. Comply with, or even exceed, the requirements of the laws and regulations related to safety, health and working conditions, including welfare facilities.

Ways to promote cooperation

Invite workers to advise on ways to improve working conditions on the site, especially the welfare facilities they use every day. Paying attention to and implementing workers' suggestions on ways to improve the site layout will increase their satisfaction with the site and have a positive impact on the quality of the work as well as on productivity.

Some more hints

1. Reduce the length of internal routes used by workers - or for moving materials and equipment - within the

site to increase work efficiency. This will reduce the time taken to complete the project, as well as its cost, and benefit both employers and workers.

2. When workplaces are located at more than 5-10 minutes' walking distance (horizontally or vertically), consider adequate portable sanitary facilities near these workplaces.
3. Whenever possible, consider parking areas that workers might use every day according to the means of transport they regularly take between their homes and the construction site.
4. Keep all temporary facilities tidy and clean all the time.
5. All temporary facilities should be removed as soon as they are no longer used or when the construction project comes to an end. The site should also be cleaned and left in the same condition that it was before – or even better.

Points to remember

A well-organized site layout provides good working conditions and consequently improves safety and health at the workplace.

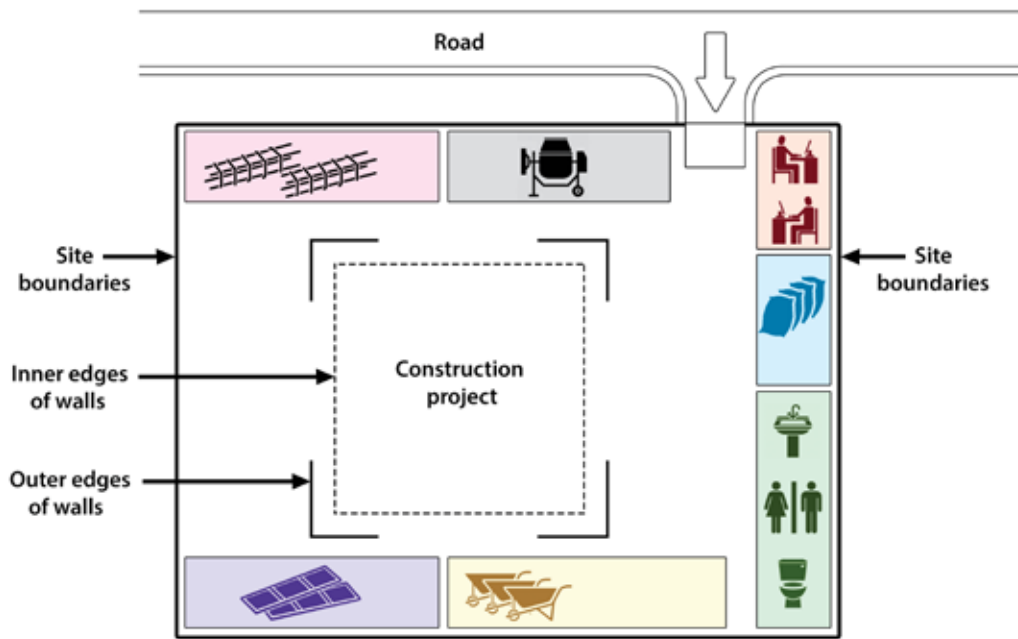

Figure 2.1. Example of the typical layout of a small construction site



Figure 2.2. Proper site planning and layout is essential for safety.

▶ Checkpoint 3

Clear and mark transport passageways and walkways.

Benefits

Workers on construction sites need clear, marked transport passageways and walkways to guarantee safe access to the site and the movement of materials. If these are not properly laid out, workers have to find alternate routes to walk or carry materials. In these conditions workers are more exposed to accidents. Moreover, workers have to be extra cautious and take longer to complete their work.

The transport passageways and walkways should be kept clear without obstacles (materials and equipment) so that workers can walk safely and move light materials easily. This contributes towards creating an efficient and productive work environment.

How to improve

1. Walk around the construction site and decide where the main transport passageways and walkways should be.
2. Consider the work flow and select safe and time-saving transport passageways and walkways.
3. Mark the identified transport passageways and walkways using available materials.
4. Remove unnecessary materials from the transport routes to the site.
5. Tell workers not to place any machinery or objects on the access routes to the site.
6. Pay special attention to removing nails and other sharp materials that might cause serious foot injuries to workers and others.
7. Instruct workers to use only designated transport passageways and walkways.

Ways to promote cooperation

Clear and marked transport passageways and walkways are basic safety issues at any construction site. Everybody at the workplace can and should contribute towards improvements. Walk around the site with workers and ask for their ideas. Assign someone to remove items and materials from the access routes so that the benefits can be shared by all.

Some more hints

1. Assemble a joint team to monitor and ensure that transport passageways and walkways are kept clear for safety reasons.
2. Discuss and agree upon who should be responsible for the safety of these access routes and for their maintenance. Allow assigned workers sufficient time to mark these transport passageways and to remove unnecessary materials from them.
3. Change these transport passageways and walkways as the construction work progresses and according to needs.
4. Keep the surface of transport passageways and walkways even with no holes. Even if you have removed dangerous materials, an uneven surface might cause an accident as the risks of slipping and tripping will be increased.
5. Provide lighting for transport passageways and walkways if working in covered areas or at night.
6. Provide waste containers so that workers can dispose of unnecessary materials and keep the access routes clean and safe. Containers should be placed near the transport passageways.
7. Prepare and label separate containers for materials to be reused or recycled, and for dangerous materials (e.g. broken glass, nails).

Points to remember

Clear and marked transport passageways and walkways make the work at the construction site safer, easier and more efficient.

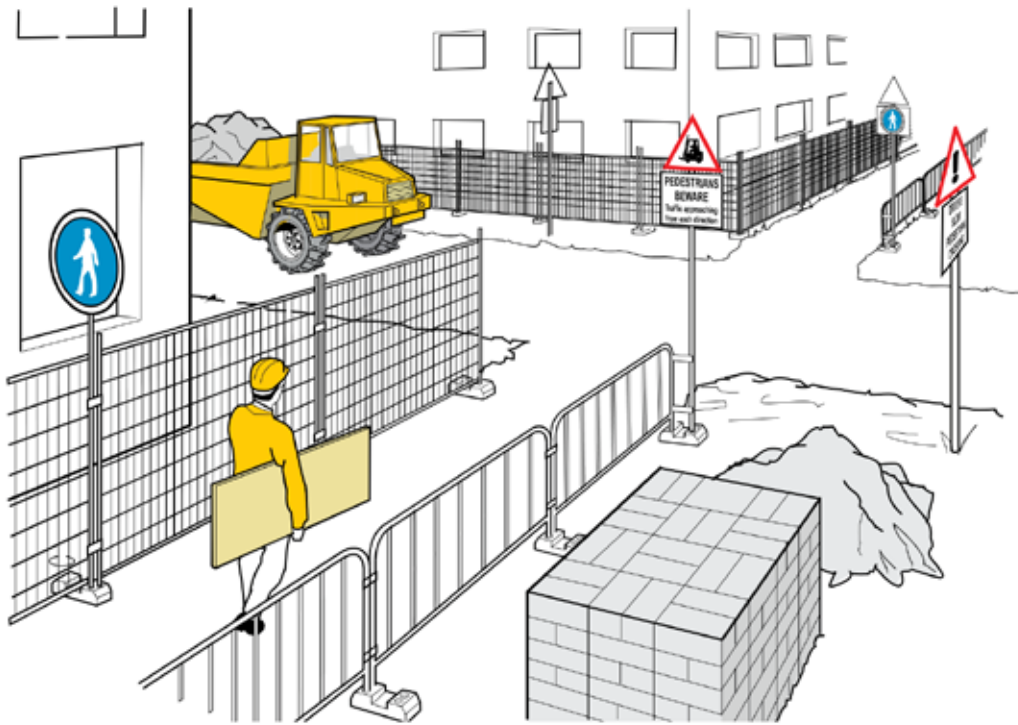

Figure 3.1. Provide clear and safe transport passageways and walkways on the construction site. There are various methods of marking these ways and ensuring that they are kept clear.

Note: This graphics is courtesy public sector information published by the Health and Safety Executive, United Kingdom, which is licensed under the United Kingdom Open Government Licence v1.0



Figure 3.2. Remove or hammer down any nails projecting from the woodwork to prevent foot injuries.



Figure 3.3. Place containers near the transport passageways for the collection of unnecessary materials.

▶ Checkpoint 4

Provide unobstructed escape routes for emergencies and for emergency vehicles.

Benefits

All construction sites need a plan for practical fire prevention and emergency evacuation. Construction sites use many flammable materials, such as wood, chemicals and oil. These are often stored in cramped spaces and can easily cause a fire, which then spreads quickly to all work areas.

When managers and workers are familiar with the evacuation routes, evacuation in an emergency will be faster and safer.

These arrangements will save the lives of many workers on the construction site.

How to improve

1. Secure the appropriate number of unobstructed exit routes from every work area. Remove all materials blocking the exits.
2. Regularly check that the evacuation routes are clear. Do not lock the door to any evacuation route. Keep routes clear for emergency vehicles.
3. Ensure that all construction workers at the workplace know the nearest evacuation exits.
4. Make sure that there are clear signs to indicate the evacuation routes and emergency exits. Emergency lights may be required.
5. Provide a sufficient number of fire extinguishers in each work area. They should be within reach of all construction workers - and everyone should know how to use them.
6. All construction workers should have training on how to evacuate the work site. Evacuation drills should be planned and implemented.

Ways to promote cooperation

Employers and workers should jointly check that the evacuation routes are unobstructed and that there are fire extinguishers. Plan and carry out a fire evacuation drill with all the workers and other contractors at the site. Seek advice and cooperation from the local fire station to ensure the successful implementation of these measures in the event of a fire.

Some more hints

1. Every work area should have at least two unobstructed exit routes for emergency evacuation. If the workplaces are on the second or higher floors, secure an additional escape route in addition to the standard evacuation routes.
2. Designate an open area at the construction site - or in the vicinity - as the meeting (assembly) point, and instruct everyone to proceed to this area during an evacuation.
3. Check the expiry date of fire extinguishers regularly and, if it has been exceeded, take immediate action to replace the expired fire extinguishers with new ones.
4. All the instructions on how to use fire extinguishers and the signs for evacuation routes should be written in the local language and, if relevant, in the languages of migrant workers who do not understand the local language.

Points to remember

Unobstructed and well signed escape routes will save the lives of construction workers in an emergency.

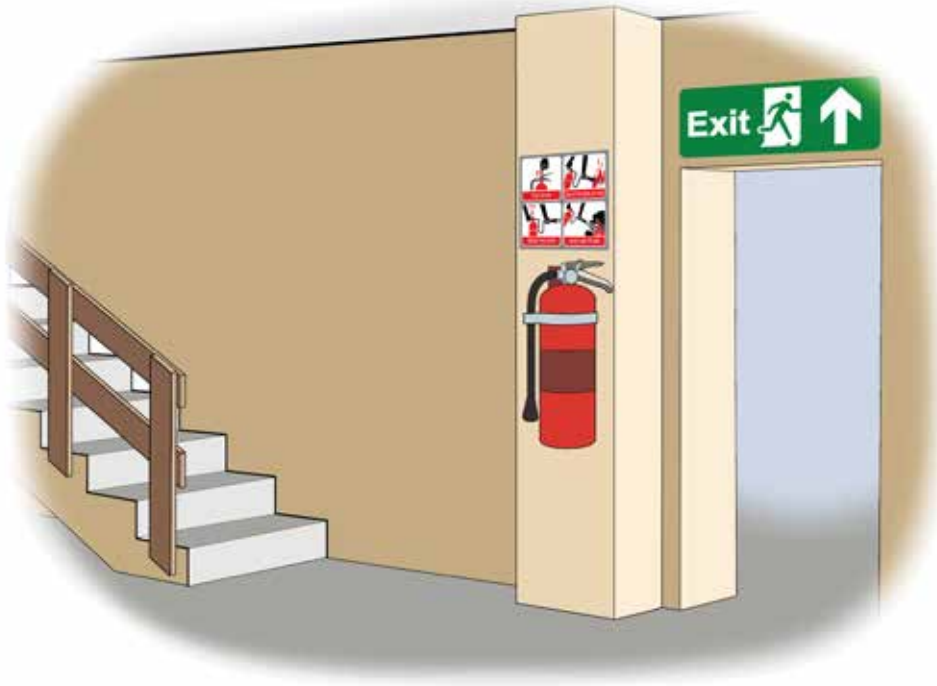
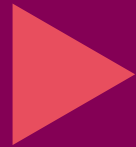

Figure 4.1. Provide the appropriate number (at least two) of unobstructed exit routes to enable all construction workers to evacuate in an emergency.



Figure 4.2. Provide that a sufficient number of fire extinguishers are within easy reach and ensure that workers know how to use them.

A series of horizontal dotted lines spanning the width of the page, intended for writing or drawing.



Chapter 2

Work at height

(Checkpoints 5 - 11)

► Checkpoint 5

Build guard-rails to prevent falls from edges and openings on the construction site.

Benefits

Guard-rails are one of the most effective measures to prevent falls from heights on any construction site. They may be used on the edges of buildings and other structures, as well as adjacent to openings and deep excavations. For small openings, an alternative measure is to cover them.

The location of edges and openings may change as the construction work proceeds. New unprotected edges and openings might result in workers falling from heights, causing serious accidents. It is not difficult to make a guard-rail or cover by using readily available materials at the workplace. This will ensure that workers can work safely and comfortably.

How to improve

1. Look around the workplace and identify places that have unprotected edges or openings, or inadequate guard-rails or covers that need to be repaired or replaced with new ones.
2. Take action to build guard-rails that are strong enough to prevent falls where needed or to cover the openings. Assign workers to make these guard-rails or covers. Provide them with the necessary materials, such as adequate pieces of wood or metal, which should be available at the construction site.
3. Inform workers when the dangerous edges and openings have been properly guarded or covered.

Ways to promote cooperation

The nature of the work on any construction site changes as the project progresses. It is vital that there should be cooperation and communication between the workers and employers so that they know when new edges or openings will be created. Several groups of subcontractors may be involved in different jobs at the construction site at the same time, and only a few might be aware of the existence of edges and openings and future plans. Maintain good communications with all those involved in the site and make joint plans to protect edges and openings.

Some more hints

1. Check that the guard-rails are strong and rigid enough to prevent workers from falling if they trip or lean against them. Ropes or chains do not fulfil this criterion, as they do not provide rigid protection.
2. Ensure that covers are designed to support the impact or weight of a worker treading on them.
3. Whenever possible give priority to steel-based materials, in particular for guard-rails. If wood-based materials are used, make sure they are not painted with opaque paints so that defects cannot be seen.
4. Organize regular meetings to which workers doing different jobs are invited, so that they may exchange information on guard-rails and openings.
5. Invite experienced workers to give their ideas on how to build the necessary guard-rails, covers and any other protection measures.
6. Decide who is responsible for implementing the agreed solutions. The site manager should allow the workers assigned to fulfil their responsibilities.

Points to remember

Simple guard-rails and covers can prevent workers and others from serious accidents.

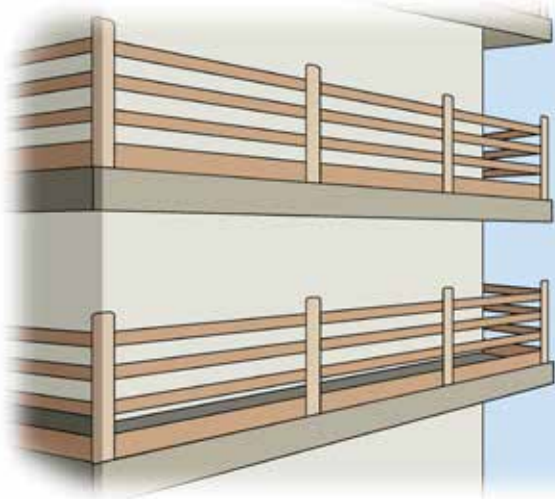

Figure 5.1. Installing safety guard-rails is a practical measure to prevent accidental falls from heights.

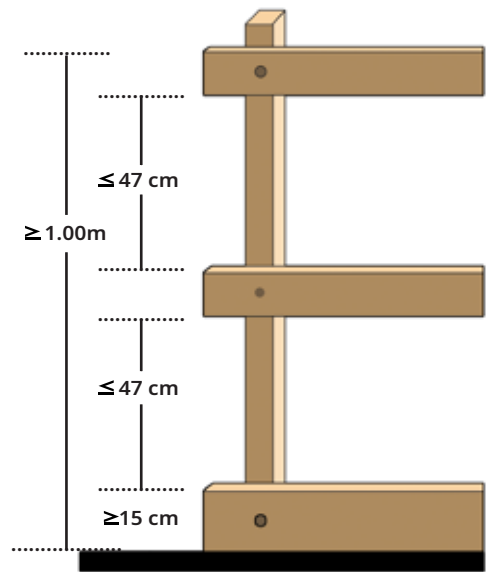

Figure 5.2. Example of a typical guard-rail and its dimensions.



Figure 5.3. Build a guard-rail or cover all the openings.

▶ Checkpoint 6

Erect and dismantle scaffolding safely.

Benefits

The erection and dismantling of scaffolds is dangerous if not well-planned, and many accidents occur during this work.

Only trained workers should be involved in erecting and dismantling scaffolds, and measures should be taken to prevent other workers from approaching the area where this work is being conducted.

Before starting either of these tasks, workers should be instructed on the correct sequence in which the particular scaffolding will be erected or dismantled, and on the personal protective equipment they should use. Dismantling the scaffolding should be done in the reverse order to erecting it.

How to improve

1. Ensure that safe procedures for erecting and dismantling the scaffolding have been prepared. Follow these procedures; any disagreements should be resolved before continuing the work.

2. When the scaffold has been erected, explain the most important restrictions to those who will be working on it. These may include the loads (materials, equipment) that can be taken on to the scaffolding, and the wind velocity at which all workers should stop working immediately.

Ways to promote cooperation

Experienced workers know the dangers of erecting and dismantling scaffolding. They do this every day, but they also know that many accidents happen during this process. Invite them to give their advice on ways to improve safety. Pass on the message that individuals are responsible for their own safety and that others might be affected by their actions. Safety is a team effort.

Some more hints

1. Restrict access to the area underneath the scaffold that has to be erected or dismantled so that no worker can access the area, apart from those directly involved in the work. Post signs in different places informing workers that it is forbidden to pass the safety barriers. This area must be large enough to store all the required scaffolding materials.

2. Ensure that the ground is level and sufficiently stable to support the scaffold. If needed, remove a layer of soil to reach the hard soil underneath and put down pieces of wood (or other resistant materials) of sufficient width and thickness, following the instructions of the site manager.

3. With the design on hand, start erecting the structure from the bottom to the top (or, if dismantling, from the top to the bottom) and, as the work progresses, place anchors according to the design.

4. After the scaffold has been erected, have it checked by another person and record all the controls carried out. Ask the site manager to conduct a final check before using the scaffold.

Points to remember

Erecting and dismantling scaffolding is very dangerous and should only be carried out by trained and experienced workers.



Figure 6.1. Restrict access to the area where the scaffolding will be built, and ensure that the ground is level and stable enough to hold the scaffold.

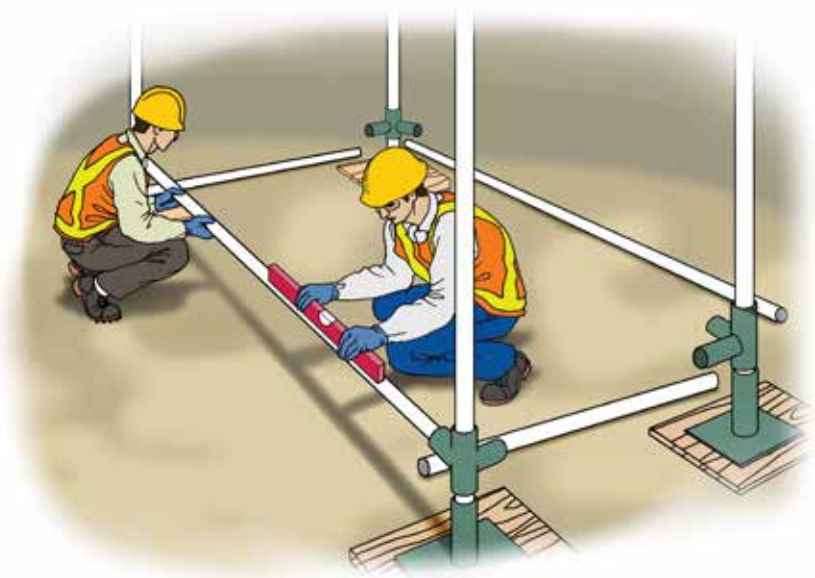

Figure 6.2. The first section of the scaffold should be horizontally level and perfectly upright (installers should use spirit levels to verify this) - this is of utmost importance as it will "guide" the following sections.



Figure 6.3. After the scaffold has been erected, ask another person to check it all and record all the controls carried out.

► Checkpoint 7

Secure the scaffolding to the building in enough places to prevent scaffold collapse.

Benefits

Scaffold collapse is one of the most common causes of accidents on small construction sites. Every effort should be made to identify and reduce the risk of collapse and prevent accidents. The workers erecting the scaffold must comply with its design under the supervision of a competent person. The scaffolding must be secured to the building in enough places to provide sufficient support to prevent it from over turning, especially in windy weather. All connections should be verified against the design before the scaffold is used.

Scaffolds needs a strong platform to ensure that they can be used safely. Accidents have occurred because scaffolds are placed on unstable ground or base plates. Preventing scaffold collapse is vital for the safety of workers, as well as for the productivity of the construction business operation.

How to improve

1. Walk around the construction site and check the condition of every part of the scaffolding in terms of location, stability, and the number of workers working on it.
2. Ensure that the scaffold base plates are on stable ground or floors. Use strong base plates to stabilize the scaffold.
3. Use steel tubes, whenever possible, to build the scaffold. The tubes should be of adequate strength, the right length, and equal in size. If they are damaged or cracked, replace them with new ones.

Ways to promote cooperation

Scaffold collapse can injure many workers working on or near the scaffolding. Utmost attention should be paid to ensuring the safe use of scaffolds, and both the employer and workers should inspect the scaffold's components - such as steel tubes, connecting parts, platforms, anchorages and supports. Any damaged or unstable parts detected should be immediately replaced with safe materials. It is also very important to ask the opinion of those working on the scaffold. These workers use it every day and should be the first to notice any possible risk of scaffold collapse.

Some more hints

1. Check the condition of the scaffolding every morning before starting work. Ensure that all the connecting parts and supports are tight.
2. Examine the state of the scaffolding under various conditions: after placing heavy materials on it, when many workers are working on it, and after heavy rain or a storm.
3. Train all workers how to check the basic safety conditions on the scaffolding. Tell them to report any signs of problems they might notice - however minor - to their employers, so that they might take swift corrective action.
4. As a reference, on average, the scaffold should have, on average, one anchorage per each 20 m² of the area of the façade if the scaffold is not covered, or 10 m² if it is covered by a net.

Points to remember

Check the safety conditions of scaffolding every morning before work to prevent its collapse.



Figure 7.1. Secure the scaffolding to the building in enough places to prevent scaffold collapse.



Figure 7.2. Check the safety of the supports, connecting parts, and the platforms of the scaffold every morning before starting work.

► Checkpoint 8

Equip scaffolding with safe platforms, guard-rails and toe boards.

Benefits for workers

Working on scaffolding is dangerous on any construction site. Falling from scaffolding is a major cause of serious accidents, many of which are fatal.

All scaffolding must be designed by a qualified engineer in accordance with its use and the loads that will be on the scaffolding (e.g. workers, tools and materials).

For example, scaffolding for work involving light tools and materials for immediate use (e.g. for painting or stone cleaning) may be considered “light” or “normal”. However, work involving the deposit of bricks and other heavy materials (e.g. stones for cladding), requires much stronger scaffolding, particularly its platforms, as the loads may amount to more than four times the load of a “light” scaffold.

The site manager is responsible for specifying the limits of these loads and preparing site safety procedures, which contain all the information required by workers for using the scaffolding safely.

All scaffolding must be equipped with safe guard-rails to prevent workers falling from it. They should have the same specifications as those contained in Checkpoint 5.

How to improve

1. Inform all those working on the scaffolding which tools and materials they may carry onto the scaffold. Materials that are not needed for immediate use should not be taken.
2. Distribute the materials evenly over the scaffolding to avoid overloading and prevent collapse. They should also be placed so as not to impede the movement of workers, and guards may be required to prevent the material from falling from the scaffolding.
3. Ensure that the scaffolding has strong guard-rails on the outside to prevent accidental falls from height.
4. If the space between the scaffolding and the wall is more than or equal to 20 cm, ensure that an inside guard-rail is also built.

Ways to promote cooperation

In most cases, many workers use the scaffolding at the same time. They work together as a team, although distributed over the platforms and often at different levels of the scaffolding. All workers should cooperate to evenly distribute the materials, leaving enough space so as not to impede the passage of others. They should also agree among themselves to bring the minimum amount of materials and tools onto the platform for safe operations, and help each other to remove any unnecessary items.

Some more hints

1. The minimum width of the platforms should be 0.60 m. However, depending on the tools and materials needed on the scaffolding, the platforms may need to be wider to provide extra space for the tools and materials required for immediate use and for workers to move safely.
2. The headroom, i.e., the distance between two consecutive levels of the scaffolding, should be at least 1.90 m.
3. Any wooden material used in the scaffolding should not be painted with opaque paints to ensure that any defects are easy to detect.

Points to remember

The safe use of scaffolding depends on the loads used and their distribution over the platforms.



Figure 8.1. Bring only the tools and materials needed for immediate use and evenly distribute the materials over the scaffolding to avoid overloading.

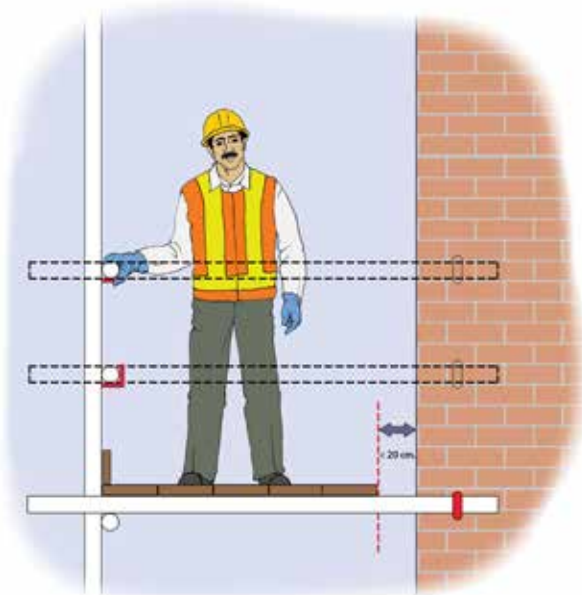

Figure 8.2. Ensure that the scaffolding has strong guard-rails on the outside to prevent accidental falls from height.

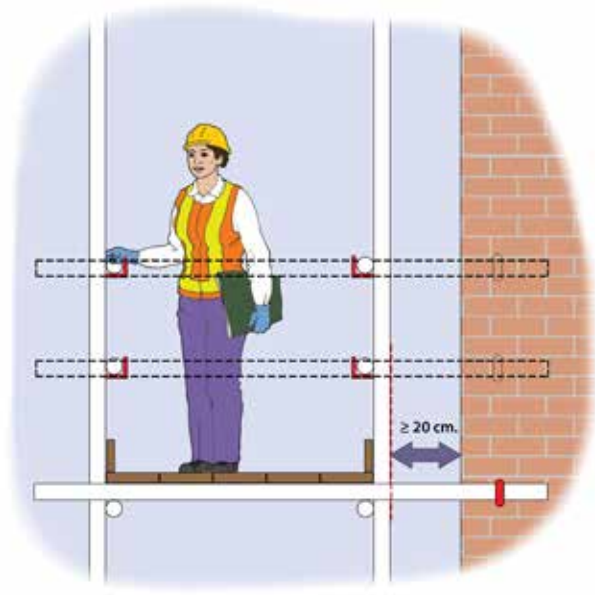

Figure 8.3. If the space between the scaffolding and the wall is more than or equal to 20 cm, ensure that an inside guard-rail is also built.

► Checkpoint 9

Secure ladders, even if only used for a short time.

Benefits

Ladders are often used on small construction sites, and it is extremely important to ensure their safe use. Wobbly ladders that are the wrong height and inadequately secured may cause serious accidents at the workplace.

There are many ways to use ladders safely and to secure them at low cost by using locally available materials. It is important that both managers and workers check the condition of the ladders and exchange practical ideas for improvements. Well-secured ladders are a prerequisite for workers' safety and efficient construction work.

How to improve

1. Walk around the construction site and identify which work areas use ladders. Check that the ladders are safe and securely fixed.
2. Ensure that the ladders are placed at an angle of about 75°, and that the top of the ladder extends at least 75 cm above the landing platform.
3. Check that all the steps/rungs of the ladders are strong enough and that they are not damaged or cracked. Make sure that they are all wide enough for the workers to use safely.
4. Secure all ladders – and there are several effective ways of doing this. Ladders must be fixed at the top and at the bottom. After securing them, check that they have no weaknesses or wobbling parts.
5. Where appropriate, attach strong handrails to the stairs to ensure safe use.
6. If workers need to carry heavy materials up ladders, ensure that they are of the correct rating.
7. Only one worker should be allowed to climb or descend a ladder at any one time. The next worker should wait until the first worker has finished using it.

Ways to promote cooperation

The safe use of ladders is a key issue on any construction site. Ask workers for their ideas on ways to design and make ladders safe and to ensure good

fixing and maintenance. Ladders should be made and repaired by skilled workers (namely, carpenters) who have practical experience. All those working on the construction site should cooperate to maintain ladders in good condition.

Some more hints

1. Train new workers how to use ladders safely, especially when carrying materials and tools, etc.
2. Ladders and their steps should be inspected regularly to detect any potentially hazardous defects at an early stage. They should be repaired with new strong materials or replaced to prevent accidents.
3. Continue to invite workers to speak up about unsafe ladders. Encourage workers to report to their employers immediately if they discover parts of a ladder that are unsafe. Repair these defects immediately to prevent serious accidents.

Points to remember

After fixing the ladder check there is no risk of it slipping.

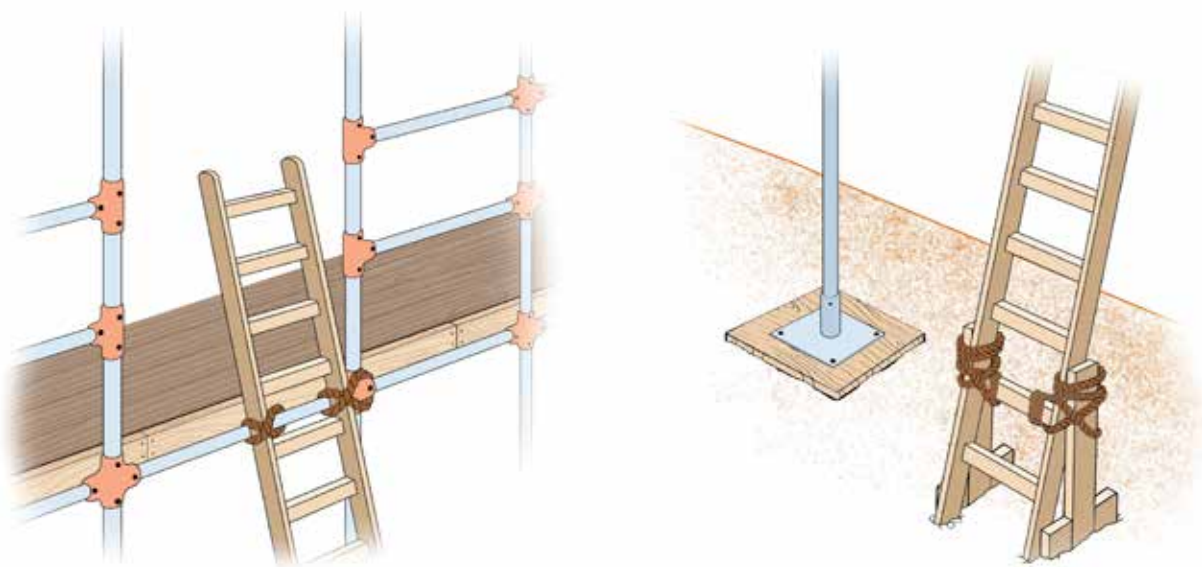

Figure 9.1. Secure ladders tightly at the top and bottom and ensure that the top of the ladder extends 1m above the landing point.

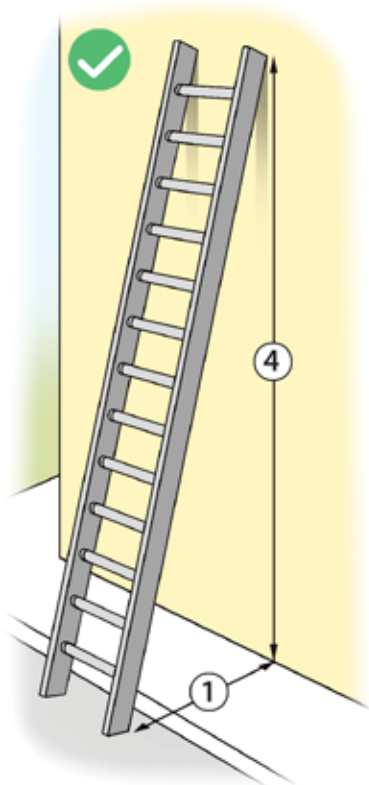

Figure 9.2. Correct one in four angle for a ladder. Ladders should be positioned at an angle of "one out for every four up."



Figure 9.3. Install a handrail on stairs to ensure safety.

► Checkpoint 10

Whenever appropriate, install safety nets to complement other systems used to protect against falls.

Benefits

Falls from heights are the main cause of fatal accidents on construction sites in most countries. Measures to prevent these falls should be implemented, such as guard-rails (referred to in Checkpoint 5).

However, there are situations in which additional measures should be taken to minimize the potential for a fall - for example, in the event that the primary measures prove to be inadequate when they are being installed. Most types of safety nets provide additional protection for workers against falls and may also protect other workers against falling objects.

The two main components of a safety net are the net itself and the method of attachment. While the net is usually manufactured and subject to specific testing at the factory, the attachment system may have to be designed by a qualified engineer if it is not included with the net itself. These support systems may be designed for horizontal and vertical nets. Horizontal safety nets are most commonly used by small construction sites, and these are addressed in this Checkpoint.

How to improve

1. Identify the work areas where safety nets need to be installed. They should be as close as possible to these areas: they should be no more than 6 m below the working level and at least 3 m wide.
2. Install the safety net following the instruction manual prepared by the manufacturer.

Ways to promote cooperation

Workers working "near" the safety nets should always be encouraged to inform the employer of any damage to the connections, or of any materials that have meanwhile fallen into the safety net. The employer should immediately take action based on this information.

Some more hints

1. The careful and regular inspection and maintenance of safety nets are of utmost importance.

2. The safety nets are usually connected to a structure that has already been built. Check these connections regularly.

3. Some nets lose their strength after some time (one year or less) as a result of the effects of ultra-violet rays.

Points to remember

Safety nets provide additional protection to workers by minimizing the effects of a fall, and may also protect other workers from falling objects.



Figure 10.1. Installing horizontal safety nets is a good additional measure to minimize the effect of a fall, in the event that the primary measures prove to be inadequate.

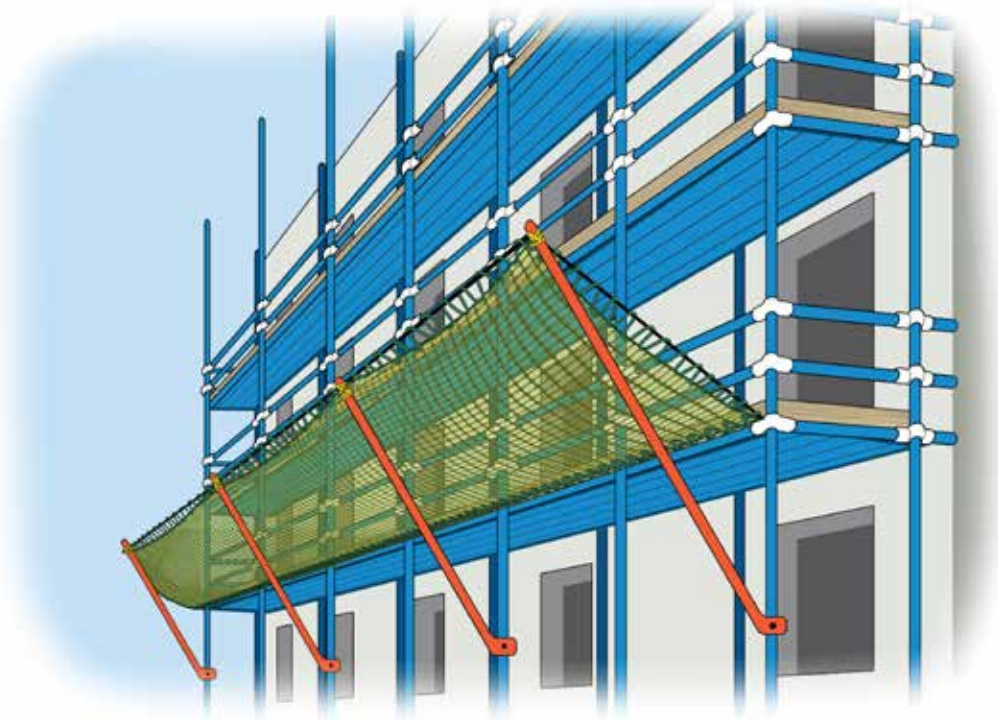

Figure 10.2. Debris nets and safety net systems create a retaining barrier against dangerous falling objects.

► Checkpoint 11

When collective protection is not possible, use a safety harness, energy absorbers and lanyards (connecting the harness to the anchor point) to limit the effects of a fall.

Benefits

Harnesses are body-holding devices that workers might use as personal protective equipment when working at height. They do not prevent a fall, but they limit the repercussions if a fall occurs.

They are very useful, for example, when workers are assembling prefabricated parts, working on masts or beams, erecting or dismantling scaffolding, or installing guard-rails on the edge of working platforms.

Harnesses should be attached to energy absorbers/lanyards which are coupled to an anchor point. A qualified engineer may need to ensure that the anchor point is strong enough to support workers should they fall.

How to improve

1. Walk around the construction site and identify the work that requires additional protection, which is not – or not yet – covered by collective preventive measures against falls (e.g. guard-rails).
2. Workers who use a harness need to be adequately trained, know how to wear the harness and make adjustments so that it fits correctly, and know how to connect it to a suitable anchor point. Workers must check that there is an adequate safety distance (clearance) to allow the system to deploy and stop the fall before they strike the ground.
3. Workers should make sure that all the components of the fall arrest system are inspected for wear and tear before each use, and further detailed inspections should be periodically conducted.
4. In addition to the procedures listed above, there are other measures that mitigate the consequences of a fall. These include safety nets and soft landing systems. Although they are not a substitute for control measures that prevent a fall, they might be used if the risk of a fall cannot be eliminated by other means.

Ways to promote cooperation

Harnesses and their associated equipment constitute part of a worker's personal protective equipment that reduces the effects of a potential fall. Whenever appropriate and following a risk evaluation, the employer should, if no other control measures are available, provide workers with this equipment. The employer should also instruct workers how to wear and use the harness, and how to connect it to the ropes.

Workers should cooperate and use the harnesses according to the instructions they receive, and encourage other workers in the same working area to also use their own harnesses.

Some more hints

1. The employer should train workers how to check that their harnesses and anchor points are in good condition and safe, and how to maintain them.

Points to remember

Harnesses are good preventive measures for workers working at height in many situations.



Figure 11.1. Example of a safety harness, and a front and back view of a worker wearing one. The employer should instruct workers how to wear and use a harness, and how to connect it to the ropes, and the ropes to the anchor points.



Figure 11.2. Use harnesses whenever performing work requiring additional protection, which is not – or not yet – covered by collective preventive measures against falls (e.g. guard-rails). Connect them to strong support systems (anchors, horizontal lifelines, etc.).



Chapter 3

Safe use of machinery and electricity

(Checkpoints 12 – 15)

▶ Checkpoint 12

Attach proper guards to prevent contact with the dangerous moving parts of machines.

Benefits

Many machines such as woodworking machines, marble cutters, cement mixers and punching machines, are used on construction sites. They are often placed in confined spaces where other workers are nearby. Injuries might occur from moving parts of the machines, such as gears, rollers or belts. Workers might also be injured when they work with or pass by machinery that is not adequately guarded. Safety can be increased by making and attaching simple, hand-made guards to moving parts of machines. They also help workers concentrate on their work and contribute to both safety and efficiency.

How to improve

1. Walk through the construction site. Identify dangerous moving parts and power transmission equipment on the machines, which require appropriate guards.
2. Place appropriate guards and shields over these dangerous parts, ensuring that they are made out of sufficiently strong materials such as wood or steel pieces.
3. Make sure that machine guards are placed in such a way that they do not obstruct the work and decrease productivity.
4. Regularly check these guards, repairing them if they become loose. Replace home-made guards with stronger ones if you find better materials.
5. Use transparent materials such as plastics or metal mesh for the guards if you need to see how the machines are operating.

Ways to promote cooperation

Observe alternative solutions and see how others use machine guards to increase safety and productivity. These guards play an important role in protecting workers from possible accidents caused by machines. Learn from others' experiences to design effective machine guards and source locally available materials to make them.

Some more hints

1. When buying new machines, ensure that they are equipped with proper guards.
2. Provide sufficient space for the machine area to prevent workers from coming into accidental contact with the machinery.
3. Keep the working surface of the machinery free of unnecessary objects.
4. When attaching machine guards, fix them tightly to the machines. Before operating a machine, carefully check each bolt and nut on the attached guards.
5. Consider the maintenance of the machine when designing the guard(s).
6. Place barricades around some machines, such as cement mixers, to prevent other workers from entering the area.

Points to remember

Attaching proper guards to machines protects workers from accidents.



Figure 12.1. Attach proper guards to prevent access to dangerous moving parts.



Figure 12.2. Example of a safety cover preventing a worker's hands from entering the moving part of the mortar mixing machine.

► Checkpoint 13

Attach easy-to-read labels and signs to critically important objects, written in the language that workers can understand.

Benefits

Construction workers need clearly-written labels and signs for machine operations or on electrical switchboards. Labels that are unclear or difficult to understand will lead to mistakes and may cause serious accidents. They will also undermine work efficiency.

Make and attach easy-to-read labels and signs to emergency stop switches and other potentially dangerous items. These labels and signs should be clearly visible, even to visitors and outsiders. They will help to avoid dangerous situations and even stop machines in an emergency. The labels must be written in the language that the workers understand.

How to improve

1. Look around the workplace and identify the places and items that need clear labels and signs. Instructions for the safe use of machines, electricity or chemicals are a priority. Ask other workers for ideas.
2. Emergency controls or switches on machines should be made clearly visible by using a bright colour. Place the controls and switches within easy reach of users.
3. All the labels and instructions should be written in the local language which all workers on the construction site can clearly understand.
4. On construction sites where there are workers of different ethnic groups using different languages, the labels and safety instructions should be written in all their languages. Consider using images to make the message really clear.

Ways to promote cooperation

Jointly design clear labels and signs to ensure the safe use of machines and electricity. Use different colours and shapes. Make sure that all workers on the construction site understand the contents of the labels and safety instructions. If there are workers using different languages, cooperate to develop labels and signs in all the necessary languages.

Some more hints

1. Use large and clear characters for labels on controls and switches.
2. Replace unclear labels or labels written in a foreign language with labels clearly written in the local languages, so that all workers can understand them.
3. When using pictures, symbols and signs for instruction, show them to all workers to make sure that they clearly understand their meaning.

Points to remember

Clear labels and signs will make work easier, safer and more productive.



Figure 13.1. Attach clear labels for machine operations.

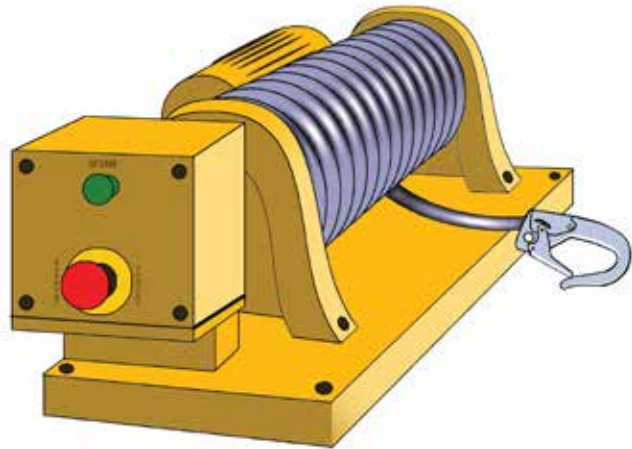

Figure 13.2. Emergency stop switches should be clearly visible to everyone.



Figure 13.3. If different ethnic groups speaking different languages work together, write the safety instructions in all their languages.

► Checkpoint 14

Check the safety of hoists, cranes and other machines every day before use.

Benefits

Hoists, cranes and other machines require regular maintenance for safety and efficiency as they can cause serious accidents if they are not carefully maintained. Broken or loose parts on any machine should be repaired immediately. Even if the machines appear to be problem-free, it is vital to inspect them regularly and plan preventative maintenance to guarantee safe working conditions and prevent accidents.

Attention must be paid to safety measures when repairing and maintaining machinery. Many accidents with machines occur during maintenance operations. For instance, it can be very dangerous if a machine accidentally starts when someone is repairing it.

How to improve

1. Check the safety of hoists, cranes and other machines every day before operating them. If any problems are found, report them and ensure that the defect is repaired by a trained competent mechanic before use.
2. In addition, set maintenance days at regular intervals for detailed checks according to the manufacturer's manual. Keep maintenance records.
3. Ensure that machine checks and maintenance are only carried out by qualified and experienced persons.
4. When maintaining or repairing a machine, make sure that it is switched off and that the electricity is disconnected and locked-out.
5. When maintenance work is being carried out on a machine, display a large tag: "DANGER. UNDER MAINTENANCE. DO NOT OPERATE MACHINE".

Ways to promote cooperation

Collect information from workers about the safety conditions of hoists, cranes, and other machines. If the workers notice or feel that something is abnormal, such as an unusual sound, wobbling, or cracks in wires and connectors, the machines should be checked and fixed

before use. Encourage workers to report anything unusual they note about the machines' condition. They work with their machines every day and are often the first to detect dangerous signs. Employers should listen to their workers' views and take subsequent action to prevent accidents.

Some more hints

1. Seek advice about machine safety from the machine shop where the machines were purchased. Train workers about basic machinery and electricity safety issues.
2. Obtain and read the machine instruction manual written in the local language to ensure safe maintenance. Place the manual near the machine for everyone's quick reference.
3. Prepare a notebook for maintenance records and keep it near the machine so that everyone can consult it. Record the dates and maintenance items you carry out.

Points to remember

Listen to the views of workers about early detection of abnormal conditions of machines to prevent accidents.

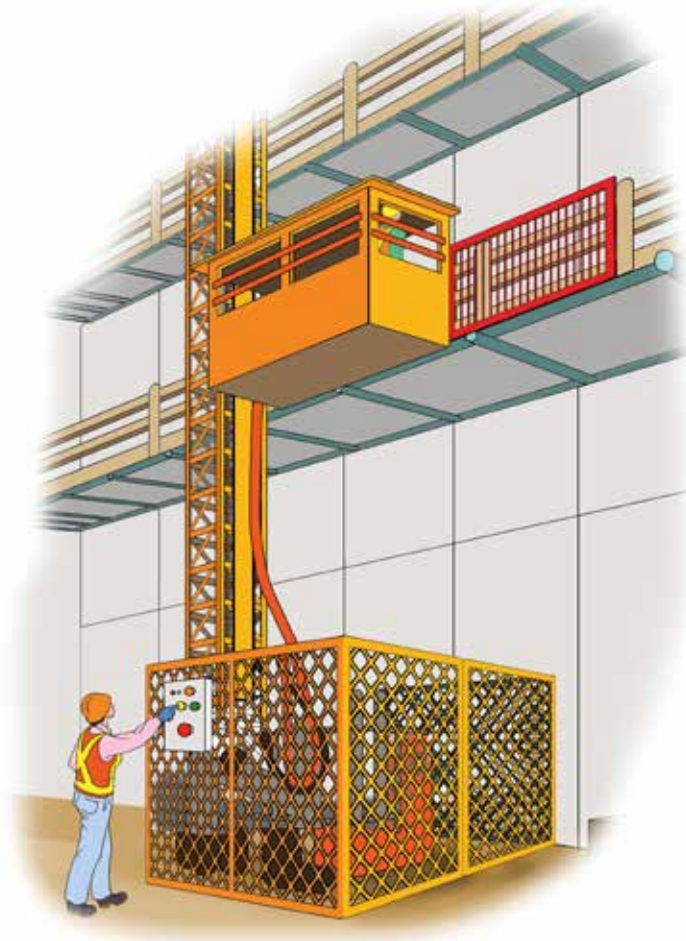

Figure 14.1. Ensure the safe use of hoists and cranes. Check the safety conditions every morning before starting work.



Figure 14.2. When maintaining or repairing a machine, make sure it is switched off and the electricity disconnected. Display a tag: "DANGER. UNDER MAINTENANCE. DO NOT OPERATE MACHINE."

▶ Checkpoint 15

Ensure safe wiring connections for supplying electricity to equipment and lights.

Benefits

The unsafe use of electricity is a major cause of accidents on small construction sites. Naked and unsafe wiring connections might, for instance, cause fatal or serious electrical injuries. An electrical short circuit can also quickly cause a serious fire. The safe use of electricity is vital for workers' protection.

Workers on small construction sites should have the basic knowledge to ensure that they use electrical installations and equipment safely. All electrical wires should be well-protected to prevent against mechanical damage and sheathed to prevent against electric shock. Pay special attention to the junctions connecting electrical wires and machines, as they often cause electrical leakage. Electrical accidents can be prevented by simple and low-cost measures.

How to improve

1. Examine the way electricity is supplied to the workplace. Observe all the electrical wires and ensure that they are properly covered.
2. If possible, fix cables overhead as this reduces the possibility of mechanical damage. If this is not possible and they are on the ground, cover them for protection purposes. This will also reduce the risk of workers tripping.
3. If some parts of electrical wires or junctions are old and uncovered, replace with new ones. Never leave any junctions uncovered and make sure that nobody touches them.
4. Remove any dust or other materials from the cables to prevent overheating and possible fires.
5. Do not allow any part of the electrical wires and junctions to become wet. Protect them from rain and other water sources.
6. Examine whether electrically-operated tools (e.g. drills and saws) might be replaced by battery-operated tools, as this would remove the possibility of an electrical hazard during their operation.

Ways to promote cooperation

The maintenance and repair of electrical cables and connections should only be carried out by experienced and qualified workers or at specialized repair shops. However, all those working on the construction site should inform their employers about any damaged electrical cables and connections on the electric machinery or tools they use.

Some more hints

1. Any damaged electrical junctions must be immediately replaced with new and safe ones.
2. Make sure electrical circuits are enclosed, insulated, earthed and properly fused. Ensure that they are not overloaded.
3. Protect all circuits and wires with circuit breakers or fuses. The main power switches and breaker boxes should be clearly marked.

Points to remember

Examine the way electricity is supplied to the workplace to ensure safety.

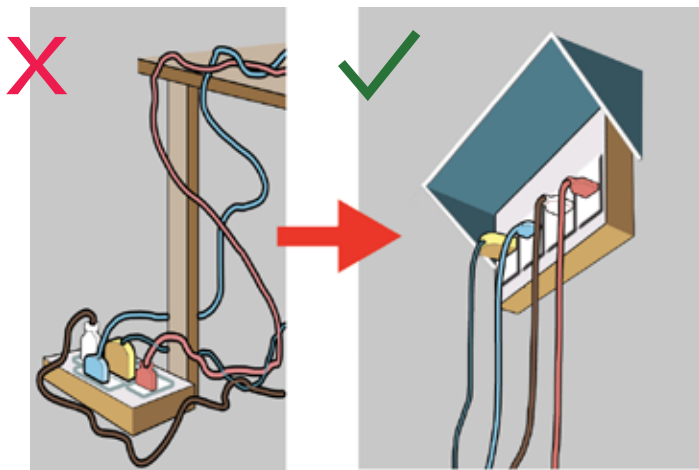

Figure 15.1. Avoid placing electrical wires and connectors on the floor. Place them on the wall instead.



Figure 15.2. Cover electrical wires to ensure electrical safety.



Figure 15.3. All electrical equipment should be earthed correctly.

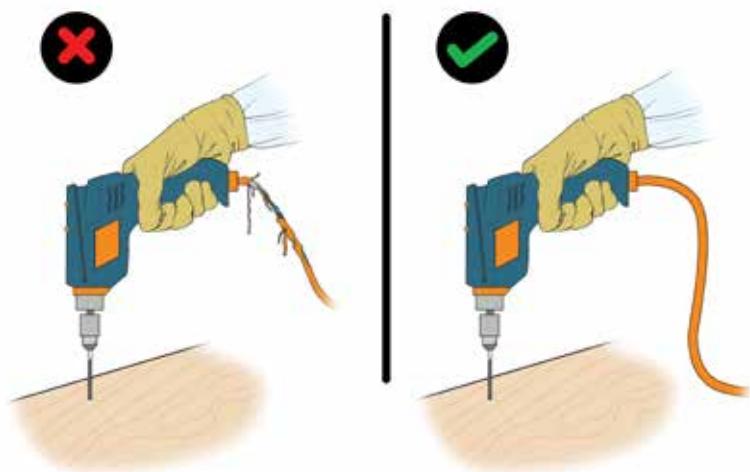

Figure 15.4. Replace a damaged cable with a new one.



Figure 15.5. Battery-operated machines without a cable might be a safer option.

A series of horizontal dotted lines for writing, consisting of 25 lines spaced evenly down the page.



Chapter 4

Materials handling and storage

(Checkpoints 16 – 20)

▶ Checkpoint 16

Use carts and containers when carrying heavy materials.

Benefits

Workers on construction sites often have to carry heavy construction materials such as cement sacks, sand or steel pipes, which can cause pain in the arms, shoulders legs or back. If a worker falls when handling or carrying heavy materials, this might result in a serious injury.

Carts and containers can help to avoid health-related problems (e.g. pain in the back or shoulders). They can be made at low cost by using materials available at the construction site itself. Moreover, they can make the work easier and more efficient, as well as reduce possible damage to expensive construction materials.

How to improve

1. Walk around the construction site and look out for any worker carrying a heavy load. No worker should carry any object weighing more than 25 kg.
2. Identify existing good examples. A number of contractors and workers may already use carts and containers. Learn from them how they use these devices.
3. Use suitable carts and containers to meet your needs. Different shaped materials need different designs. Carts and containers require sturdy wheels of an appropriate size, firm handles, and suitable grips for easy operation.

Ways to promote cooperation

Carts and containers are commonly used on many construction sites. Promote the joint use of push carts since they can make the work much easier and more efficient. Ask workers for their ideas and experiences about the best carts and containers for each job. Workers doing varying jobs would typically have different good ideas and experience in this area.

Some more hints

1. Eliminate uneven floors and holes in the transport passageways to enable wheeled devices to move smoothly.
2. Remember that larger-wheeled carts carrying heavier materials can be used on uneven or bumpy routes.

3. If wheeled devices or hoisting equipment are not immediately available, two or more workers should help each other carry heavy materials, with a limit of 25 kg. per worker.

4. Check your carts and containers regularly and always keep them in good condition. Wobbling wheels or grips will increase the risk of accidents.

5. Remember that most carts should also have brakes.

6. Undertake the regular maintenance of carts and containers to ensure safety at the workplace and work efficiency.

Points to remember

Using carts and containers to carry heavy materials makes work safer, healthier, easier and more efficient.



Figure 16.1. Use strong push carts with adequate wheels and holding points to carry heavy materials. Simple brakes should be used when carrying heavy loads, especially on ramps.



Figure 16.2. Makeshift wood planks used to cover a rough surface on a transport passageway help workers push carts more easily.

▶ Checkpoint 17

Use hoists or other mechanical means for moving or lifting heavy materials and equipment.

Benefits

Construction work typically uses heavy materials and equipment such as stones, metal bars or heavy machines, and these are often too heavy and dangerous for workers to lift manually. Workers frequently have to raise these heavy materials to higher places, which is even more dangerous and strenuous.

Hoists and other mechanical means for moving or lifting these heavy materials and equipment can reduce the workers' manual workload and lower the risk of accidents. In parallel, it is important to establish measures to use these hoists and mechanical means safely.

How to improve

1. Identify the work procedures required for handling very heavy materials or equipment. Provide appropriate hoists or mechanical means to assist these procedures.
2. Make sure that workers using the equipment are sufficiently trained to guarantee its safe operation. Only qualified workers should be allowed to operate such devices.
3. Place hoists and lifting devices in a safe area with firm supports to prevent accidents. Ensure that only operators and workers involved in the task in hand have access to the working areas of these devices.
4. Verify that the workers engaged in handling this equipment wear appropriate protective equipment such as helmets, safety shoes and gloves.

Ways to promote cooperation

The use of hoists and other mechanical means is essential when handling heavy materials. However, this can give rise to other hazards such as the risk of dropping heavy objects or the collapse of the equipment. Some groups of workers may not know what other groups are doing and approach a hoist operation area without being aware of the danger. Recommended measures include clear markings and a guard built around the dangerous area.

All those on the construction site should cooperate to ensure that all workers know the potential dangers and how to prevent accidents.

Some more hints

1. Use hoists when lifting a number of bricks supplied in pallets, or conveyers when lifting a number of separate bricks. This also applies to other similar materials.
2. Explore other ways of simple and low-cost ways to move heavy materials (e.g. lift tables, stackers and pulley systems). Do not try to move heavy materials alone.
3. Be aware that lifting devices can cause serious accidents if they collapse or if objects fall from them. A number of key factors must be observed: ensure the devices are positioned securely; make sure there are strong connections between wires and objects; ensure that the cables used are strong enough and not damaged; and build a guard around the dangerous area.
4. Carry out safety checks of the devices before starting work every morning. Any damaged cables or wobbling parts of devices should be repaired before use.

Points to remember

Use hoists and other mechanical devices to carry heavy materials. Promote cooperation to ensure the safe operation of the devices.



Figure 17.1. Use lifting equipment to raise heavy materials.



Figure 17.2. Use conveyers to lift a number of bricks and other similar materials.



Figure 17.3. There are many examples of simple, low- cost devices to move heavy materials. Cooperation between workers is important for safe operation.

▶ Checkpoint 18

Provide appropriate places for storing tools and materials.

Benefits

A variety of tools - both large and small, and some with sharp edges - are used in construction work. Leaving tools and materials in inappropriate areas of the workplace and on transport passageways and walkways can cause accidents and injuries. As a result, workers have to pay extra attention when walking and working at the workplace.

Providing an appropriate place to store tools and materials greatly improves both safety and productivity and ensures that the right tools are available for the various tasks. It also helps make the workplace safer and more productive, and workers save time as they can find the tools and materials they need more easily.

How to improve

1. Walk around the site and collect all the tools and materials scattered around. Sort them out according to their purpose.
2. Develop simple "homes" for these tools and materials. Make a convenient cabinet, hanger or box using wood pieces or other available materials.
3. Find a safe and convenient place for tools so that every worker can access them easily.
4. Hang up measures, scissors, knives and large tools - such as shovels - to save space. They are also more visible, and easy to locate.
5. Make multi-level racks to store materials. These racks can save space and clear passageways and work areas on construction sites.

Ways to promote cooperation

On construction sites, different groups of workers work alongside each other on various assignments. Providing appropriate places for tools and materials is a good way of ensuring that these groups cooperate. Discuss how to prepare "homes" for tools and space-saving racks for materials. Tools are precious and often expensive. Through cooperation, workers are less likely to lose precious tools, in addition to reducing the risk of accidents and injuries.

Some more hints

1. Place safety caps on the sharp edges of tools such as knives or scissors.
2. Draw images of the various items or tools on the ledge of shelves or the front of containers to show where each item is kept. This saves your time.
3. Place heavy tools on the lower shelf and lighter ones on the upper shelves. Use shelving materials that are strong enough to hold heavy items.
4. Put small items in appropriate containers and place these containers on the multi-level shelves.
5. Label the containers in the language that workers can understand. Where possible, use safety signs - they are easy to read and understand.

Points to remember

Return your tools to their "homes" after use to prevent them from being lost.

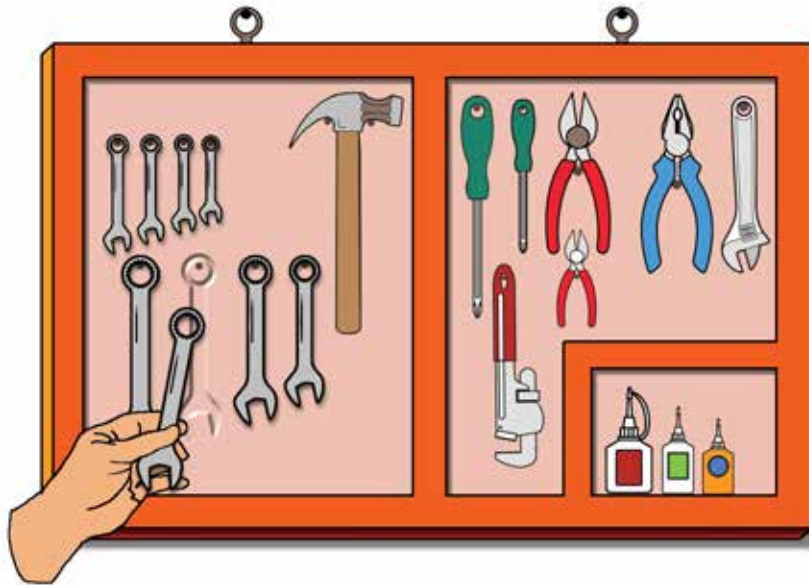

Figure 18.1. Return tools to their “homes” after use to avoid leaving the tools at the workplace, losing them, or causing injuries to workers.



Figure 18.2. Larger tools need more space. Use appropriate containers for small items.



Figure 18.3. Multi-level racks keep materials in good order and help you keep the transport passageways and walkways clear and safe.

▶ Checkpoint 19

Place frequently used materials, tools and controls within easy reach of workers.

Benefits

Construction workers use many kinds of tools and materials, some of which are small and easy to lose. Work will become easier and safer when these tools and materials are well-organized.

Frequently-used tools and materials should be placed within easy reach of construction workers. Use containers, racks or hangers to ensure they are kept in an orderly manner. This will help workers minimize unnecessary strenuous movements, such as extending their arms or bending their backs to reach these tools and materials. It will save both time and energy.

How to improve

1. Place the selected and frequently-used tools and materials within easy reach.
2. Remove unnecessary items from the workstation to clear the space.
3. Use boxes and containers to keep small items within easy reach and label them.
4. Tools, such as hammers, scissors and knives, may be hung on the side of each workbench.
5. Only place materials, unfinished products, or hand tools temporarily on workbenches.

Ways to promote cooperation

Experienced construction workers know how to use their limited space safely and efficiently. They constantly improve the efficiency of their workstations by relocating unnecessary tools and materials and making more space to organize frequently-used tools and materials. Observe the workstations of these experienced workers and learn from their practical solutions to use the limited work space more effectively.

Some more hints

1. Shelves placed close to the workstations are useful for keeping tools and materials that are less frequently – but still regularly – used within easy reach. Use drawers in the work bench for the same purpose.

2. When you keep sharp tools and items within easy reach, place the sharp side downwards, or cover the sharp point to avoid injuries.

3. Use workbenches and adequate clamps for materials so that both hands are free from holding the materials. Work will be easier and safer.

4. When working on scaffolding, smaller tools may be secured by a string or something similar to stop them.

Points to remember

Placing frequently-used tools and materials within easy reach saves time and increases productivity.



Figure 19.1. Place frequently-used tools and materials within easy reach.



Figure 19.2. Use convenient side workbenches to place necessary tools and materials within easy reach.



Figure 19.3. Use a tool belt to ensure that tools required for work are within easy reach.

► Checkpoint 20

Limit all weights to be manually handled by a worker to a maximum of 25 kg.

Benefits

Handling heavy materials manually is one of the main causes of back injuries to construction workers. These injuries are caused by a combination of both the weight of the loads and the posture used when handling them. The distances covered and the routes used compound the problem.

The ILO Maximum Weight Convention, 1967 (No. 127) states that no worker shall be required or permitted to engage in the manual transport of a load which, by reason of its weight, is likely to jeopardize his health or safety.

Studies based on Convention No. 127 have, in some countries, recommended that the maximum weight that should be wholly borne by one worker when lifting or putting down a load should be 25 kg. However, depending on the position of the load in relation to the body and, in particular, the position of the arms, this weight might be lower.

How to improve

1. Typical examples of loads that deserve special attention on any construction site include heavy bricks, especially those made from cement mixtures, and bags of cement. Identify these and other heavy loads during the planning of the construction site before buying them.
2. Choose low-weight materials that have the same function without compromising the project; for example, use lighter cement bags and smaller cement bricks in facings.
3. If weights cannot be reduced to a maximum of 25 kg. or lower, use simple tools to handle loads or mechanical means to carry them.
4. Teach all workers who manually handle loads the correct posture they should use for this task.

Ways to promote cooperation

Analyse every repetitive task involved in the work, and invite workers to discuss the best measures to reduce their exposure to incorrect postures and heavy lifting that can result in injuries. Employers are responsible for providing all the necessary means to guarantee good

working conditions and they should benefit from their workers' practical experience.

Some more hints

1. When consulting with the suppliers of materials or tools, ask for information on the weight of these goods and on the way they will be delivered and unloaded at the construction site.
2. If materials or tools must be unloaded or handled by workers (instead of machinery), give priority to purchasing materials under 25 kg. (e.g. cement bags and bricks).

Points to remember

Limiting the weight of loads significantly reduces construction workers' injuries.



Figure 20.1. When carrying heavy materials, two or more workers should help each other. Containers should have firm grips or holding points.

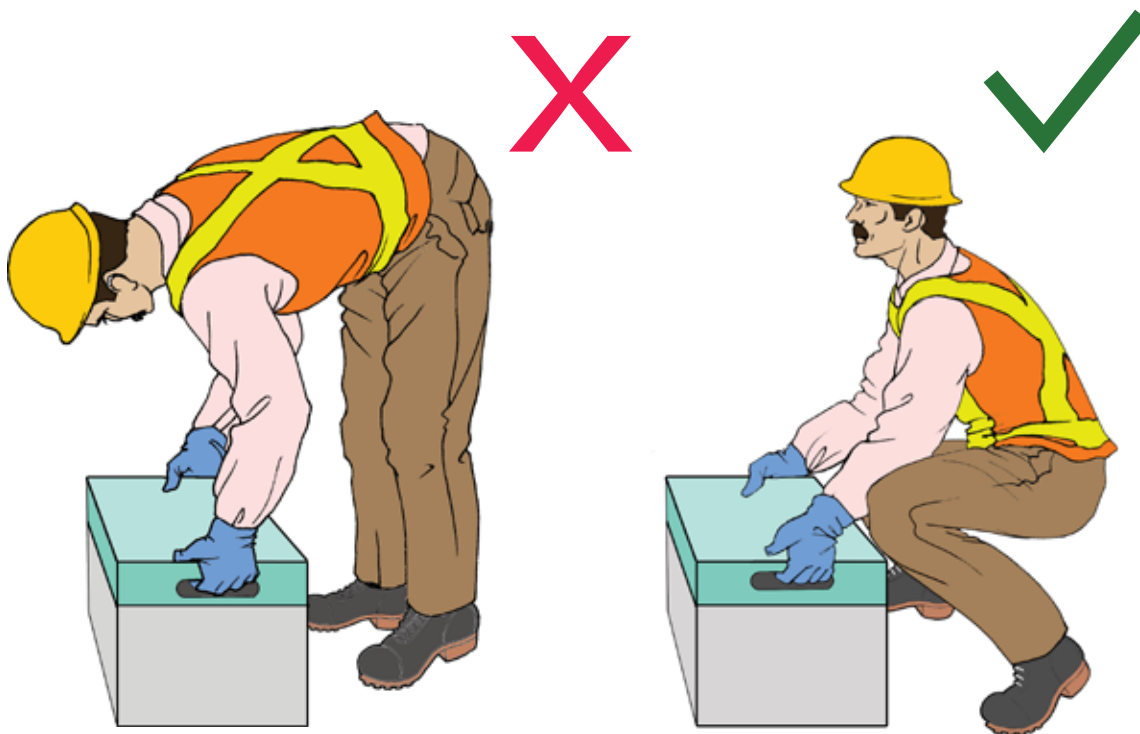
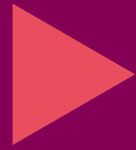

Figure 20.2. Avoid lifting loads “using” your back (see picture on left); use your legs (see picture on right). This will reduce back injuries, which is one of the main causes of injuries in construction.



Chapter 5

Physical environment

(Checkpoints 21 - 26)

▶ Checkpoint 21

Ensure that all workers have adequate lighting to work safely.

Benefits

Well-lit and pleasant working environments help to make construction work safer and more productive. There are numerous advantages to working in a bright environment. Workers tend to make fewer mistakes, have fewer accidents and less eye strain, etc.

One way of making the working environment brighter is to use daylight effectively. However, it may be difficult to get sufficient natural daylight working inside, especially in shafts or in enclosed stairways. In this case, use general artificial lights and local task lighting to supplement natural daylight. There are many ways to increase the effectiveness of artificial lights at low cost; these include the regular cleaning and maintenance of bulbs, the repositioning of lamps, or the elimination of glare. These measures will definitely contribute to improved safety and higher productivity.

How to improve

1. Open windows and doors to let more light into indoor workplaces. Clean glass doors and windows, and remove any objects that block out the daylight.
2. Identify the workplaces and passageways where daylight itself does not provide enough light for the work. Install sufficient artificial lighting.
3. Improve existing artificial light sources used in the workplace. Clean all the bulbs and reposition the light sources for maximum effectiveness.
4. Provide local task lights for work requiring precision, inspection tasks and dangerous work, when workers need a brighter light.
5. Attach a lamp shade to the local task light to protect workers' eyes from the bulb's bright glare.

Ways to promote cooperation

Jointly examine the lighting conditions prevailing at the construction site where workers are employed and work alongside each other. Identify the work that requires additional lighting to ensure safety and increase efficiency. Workers' past experiences of eye fatigue and near-miss accidents should be discussed to identify possible preventive measures. Develop ideas for using the three light sources (daylight, general

artificial site lighting and local task lights) most effectively.

Some more hints

1. Place the light sources on the opposite side of the hand that the worker most uses, so that it does not cast a shadow.
2. As the intensity of daylight fluctuates with the time of day, weather and season, consider this factor when choosing additional artificial light sources.
3. Use reflectors to better disperse the general artificial lighting.
4. Remember also that if daylight is too strong or too bright, it may reduce visibility.

Points to remember

Good lighting is essential for safe work and helps construction workers' efficiency.



Figure 21.1. Provide adequate task lights to ensure that work can be completed safely - which also increases efficiency.

► Checkpoint 22

Protect workers from heat and cold.

Benefits

Many workers on small construction sites work outside for long hours every day. They need to be protected from heat stress and dehydration. Heat from the sun can increase construction workers' fatigue and adversely affect the quality of their work. They should not have an unnecessarily high workload, and have enough water and sufficient rest.

Many construction workers have to work outside in the winter when temperatures are low, and this can also cause exhaustion. They need adequate protection against cold weather as they lose a considerable amount of energy when exposed to cold weather/wind.

How to improve

1. Use shades to protect your eyes from the strong heat of the sun.
2. Protect your skin against strong sunshine. Brightly-coloured and long-sleeved clothes are appropriate when working in strong sunshine.
3. Wear a hard hat with a large brim to protect your head from falling objects and to reduce exposure to radiation and heat.
4. Redesign the work schedule to reduce exposure time in strong sunlight or cold weather. In the sunny season, start work early and avoid working at the hottest part of the day.
5. Drink sufficient water when working in hot working environments.
6. In the cold season, start working late or increase indoor work.
7. In cold weather, wear woolen clothing covering the neck and warm gloves. Have a hot drink regularly to keep the body warm and prevent dehydration.

Ways to promote cooperation

Experienced construction workers have many practical ideas on how to protect themselves against excessive heat and cold. Employers should arrange appropriate work schedules to avoid exposure to these conditions. Encourage an exchange of experiences to establish

more suitable work schedules. Sharing good examples of protective clothes made from local, low-cost materials is also recommended. Raise people's awareness of the importance of protecting themselves against excessive heat or cold.

Some more hints

1. Take frequent short breaks when working in strong sunlight.
2. Undertake heavy work, such as carrying heavy loads, in the early morning or in the late afternoon when it is not so hot.
3. Use appropriate shoes to prevent accidental falls when passageways are frozen in cold weather.
4. Learn how to avoid heat stroke or frostbite and, if they occur, how to manage them.

Points to remember

Protecting workers from excessive heat and cold is a prerequisite for ensuring safety and health on any construction site.



Figure 22.1. Use shades to protect workers from the strong heat of the sun when they are working in open-air environments.



Figure 22.2. Neck protection from sunburn for safety helmet.



Figure 22.3. Construction workers working in cold weather need warm protective clothes, gloves and shoes.

► Checkpoint 23

Ensure safe work on rainy days and at night.

Benefits

Workers on small construction sites work in an open-air environment, even when it is raining. Construction work on rainy days is more dangerous as workers have to walk over slippery walkways, use wet ladders and work on wet scaffolding. In addition, if the weather is hot and humid, workers quickly become exhausted.

Construction work might have to continue at night to meet the construction work deadline, and working after dark is very dangerous. If this situation is unavoidable, hazardous tasks such as working at height and moving heavy materials should be deferred as much as possible. Indeed, working at night should be limited by adjusting the work schedules.

How to improve

1. Work at a slower pace on rainy days to avoid the possibility of accidents caused by slipping.
2. Walk carefully on the construction site. Never run!
3. Wear an appropriate raincoat when working. Ensure good visibility to be able to work safely.
4. Suspend construction work temporarily during heavy rain. Wait until the heavy rain has stopped.
5. Eliminate or minimize work at night by adjusting the work schedule.
6. When working at night, provide sufficient artificial lighting to ensure all workers on the construction site can see the transport passageways and walkways, platforms, and all the dangerous moving parts of hoists and other machines.
7. Instruct drivers to take extra care at night, by driving their trucks and vehicles slowly and safely.

Ways to promote cooperation

Working on rainy days is dangerous. It is important to discuss ways to prevent accidents caused by slips and falls. Work should be at a slower pace on rainy days for safety reasons. Also discuss how to avoid working at night. Should there still be a need to work at night, high-risk work should be postponed to the next day. Install sufficient additional lighting sources to ensure all workers can see the walkways, materials and equipment.

Some more hints

1. Provide good quality personal protective equipment (raincoats and waterproof footwear) for all workers to ensure safe work on rainy days or at night.
2. Instruct workers to work slowly and carefully on rainy days and at night.

Points to remember

All necessary measures should be taken to ensure safe work on rainy days and at night.



Figure 23.1. Work slowly and carefully on rainy days to prevent accidents caused by slipping. Wear an appropriate raincoat.



Figure 23.2. Adequate additional lighting is needed when working at night or in dark areas to prevent accidents.

► Checkpoint 24

Ensure that all sources of noise, vibration and dust are enclosed or isolated.

Benefits

Many machines used on construction sites are noisy. Excessive noise disrupts communication between construction workers, who may not be able to hear warnings from their colleagues and therefore be more prone to accidents. Noise could also cause hearing loss among workers.

There are also machines that vibrate and may cause back pain, reduced blood circulation in fingers, and other health problems.

Dust is another health hazard to construction workers. There are many sources of dust on construction sites, such as sand and cement, and demolition work can be particularly dusty. These dust sources negatively affect workers' health and efficiency. Prolonged exposure to dust can cause lung diseases, and cement may cause allergies.

How to improve

1. Identify the sources of noise and vibrations, such as noisy machines or vibrating tools.
2. Find the causes of dust at the workplace, such as sand and cement.
3. Move the noise and dust sources to a separate area restricted to the workers concerned, and ensure that they are duly protected.
4. After moving these hazardous sources, enclose them or screen them off to isolate them from the workers.
5. Spray water in the dusty working environment to prevent dust from spreading.
6. Use appropriate personal protective equipment such as earplugs, masks, gloves or goggles when the hazards cannot be eliminated or risks reduced.
7. Look for alternative machines and tools with low vibration to reduce exposure.

Ways to promote cooperation

Moving sources of noise or dust (caused inter alia by work processes or machinery) to an isolated place is a good risk-prevention measure to reduce workers'

exposure to these hazards. Experienced workers may share good ideas on how to successfully isolate the hazardous sources on the construction site. If they cannot be moved, there are many practical solutions for reducing these hazards, such as hand-made covers, simple partitions, or local exhaust ventilation methods.

These can be made using available materials such as wood or steel plates; noise-absorbent material can also be used to make screens and enclose the hazardous sources.

Some more hints

1. Workers experiencing hearing difficulties might be suffering from noise exposure and need to see a doctor.
2. Workers with coughs, sputum or shortness of breath might be affected by dust exposure and also need to consult a doctor.
3. Some construction materials might contain asbestos that causes cancer. Replace the asbestos-containing materials with safer ones.
4. Ensure that the noise and dust sources at the workplace do not pollute the environment of surrounding communities.

Points to remember

Isolate or replace the sources of noise, vibration and dust.

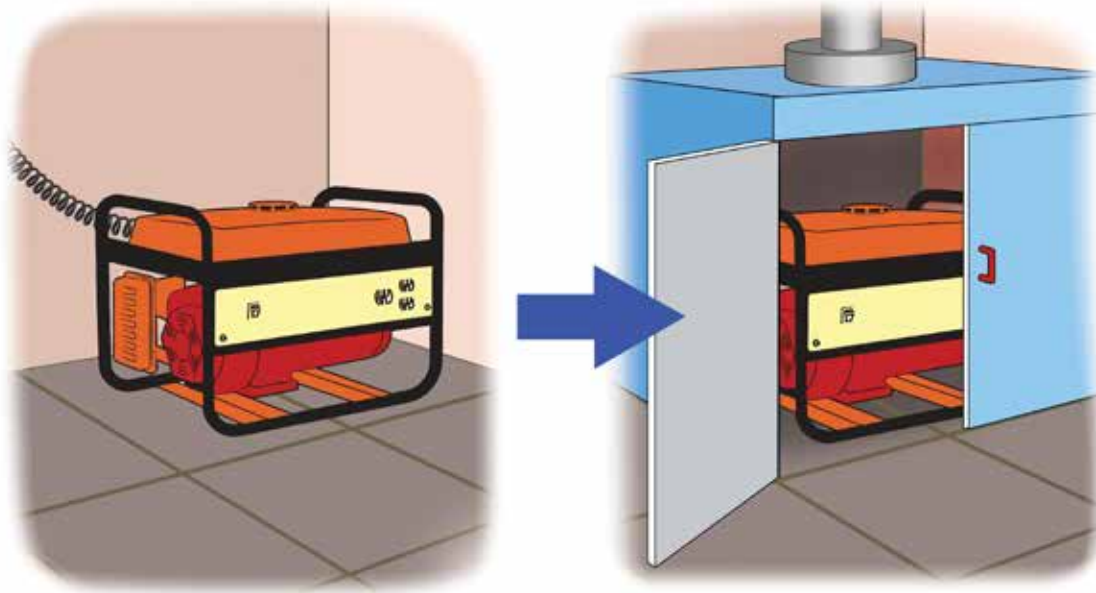

Figure 24.1. Noise disrupts communication between workers and undermines safety. Whenever possible, isolate the source of the noise by placing a cover on it, or replace it with a quieter one.



Figure 24.2. Direct water at the tool cutting point to suppress dust.



Figure 24.3. Wear personal protective equipment when noise, vibration and dust cannot be controlled at source.

▶ Checkpoint 25

Keep all containers of hazardous chemicals in designated and lockable areas.

Benefits

Construction sites use many chemicals such as paints, solvents and glues, which can cause health problems for workers if they are not properly handled. Using chemicals indoors without sufficient ventilation is very dangerous, as they might cause headache and dizziness and disrupt workers' concentration.

It is advisable to design a well-locked storage place to isolate hazardous chemicals, and to label all the containers to avoid misuse and poisoning. The labels should be clear and easy-to-read, written in the languages that all workers understand. Chemical containers should be covered to preserve the product and to avoid health risks. This will also decrease the risk of a fire.

How to improve

1. Walk around the construction site and locate the places where chemicals are used.
2. Check whether all the bottles and containers storing chemicals at the workplace have labels and covers. If not, attach them.
3. Label the name of the chemicals in the local language using large letters. Make sure that all workers on the construction site can understand the labels.
4. The labels of toxic chemicals should have the warning: "TOXIC". Use easy-to-understand danger symbols (and if applicable standard symbols), such as a skull and crossbones.
5. Replace old and unclear labels with new and clear ones.
6. Ensure that lids are used on chemical containers. Only open the chemicals storage containers for a minimal amount of time when using them. Close them again immediately after use.

Ways to promote cooperation

Build a designated and locked storage warehouse for keeping chemicals. Collect all the chemicals storage containers from the various work areas and instruct workers to store them in the designated area after use.

Attach labels to all chemicals containers and make sure they are covered. When preparing the labels, make sure that everyone at the workplace understands them.

Some more hints

1. Use small containers. Small openings reduce the amount of vapour loss through evaporation. Do not use chemicals containers for any other purpose.
2. Collect information on the toxicity, flammability and emergency measures for the chemicals. The chemicals suppliers have a duty to provide information sheets with their products.
3. Make a list of the chemicals used on the construction site. Record when you purchased them and put labels on them.
4. Keep used chemicals containers in a designated place so that you can send them to appropriate organizations that, in accordance with the national law, may dispose of them safely.
5. Replace hazardous chemicals with less hazardous ones, whenever possible.

Points to remember

Putting labels and covers on chemical containers is a low-cost way to ensure safe use of chemicals.

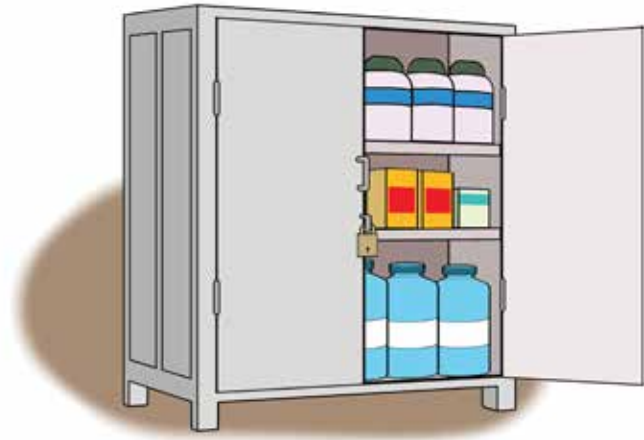

Figure 25.1. Keep all chemicals containers in designated and lockable areas. Label all containers in the languages that all workers can understand.

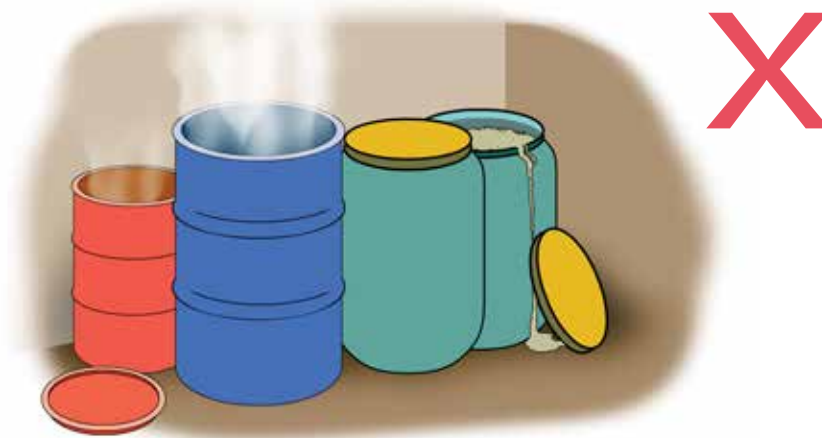

Figure 25.2. All chemical containers should have covers to prevent leakage and the evaporation of dangerous chemicals.

► Checkpoint 26

Provide personal protective equipment for all workers according to their protection needs.

Benefits

Workers on small construction sites should wear appropriate personal protective equipment (PPE), including a helmet and safety shoes, at all times - and, where needed, safety gloves, clothes and goggles etc. PPE protects workers from various hazards. A helmet, for example, safeguards workers from falling objects or from hitting their heads against hard materials. Safety shoes protect them from nails and other sharp items on the floor; and safety gloves protect their hands from sharp items and hazardous chemicals. A safety vest makes workers visible. Using PPE not only promotes safety on the construction site but also contributes towards the efficiency of construction work.

It is important to select PPE carefully and use the equipment properly; otherwise, workers may believe that they are well protected when, in fact, they are not. PPE needs to be well-maintained to be effective. The equipment should be cleaned after use and placed in a designated area. If it is broken or torn, it should be immediately fixed or replaced. This is very important to protect workers from accidents.

How to improve

1. Provide workers at the construction site with helmets and safety shoes and, where needed, with gloves, goggles, masks, clothes, and vests and harnesses.
2. Ensure that all workers are provided with PPE which fits their body size.
3. Workers handling chemicals and working in a dusty environment need appropriate masks. When they are working with volatile chemicals such as solvents or glues, they required masks with appropriate filters containing activated carbon. Do not use expired filters in masks.
4. Workers who are exposed to a high level of noise need ear protection. If a colleague is 2 m away from you and you cannot hear them when they speak normally, then the level of noise is likely to be high enough to damage hearing.

5. Masks have to be well-fitted to the face shape of each worker. Change clothes after work before going home. Do not bring used PPE to your home, as it spreads chemicals and hazardous dust to families.

Ways to promote cooperation

Continue working together as a team at the workplace to remove hazards, rather than merely instructing workers to wear PPE. Workers should not be complacent with just wearing PPE as it is not perfect. It can also be sometimes uncomfortable for workers in hot climates. Accidents and injuries can only be prevented by encouraging strong cooperation between all those involved on the construction site.

Some more hints

1. Choose protective gloves suited to your job. Thick gloves are needed for jobs that require grip strength (cutting long wood materials, etc.) or handling sharp items (processing metals, etc.). Use appropriate gloves when handling chemicals.
2. All those on the construction site, including managers, supervisors, providers and visitors.

Points to remember

Select and use the correct and effective PPE.



Figure 26.1. Use appropriate PPE that fits the body size of each individual worker.



Figure 26.2. Keep PPE in an appropriate place for convenience and good maintenance.



Chapter 6

Welfare facilities

(Checkpoints 27 – 32)

Checkpoint 27

Provide safe drinking water that is easily accessible to all workers.

Benefits

It is essential to provide workers on small construction sites with safe drinking water, especially in a hot environment where they can easily lose water from the body and become thirsty. This increases fatigue and lowers productivity. Workers in cold environments need to have access to hot drinks.

The water should be clean and not contaminated with dust, chemicals or other hazardous substances. Drinking water facilities should be placed in such a way that every worker has easy access to water and does not lose time when getting a drink.

How To Improve

1. Find convenient locations to place drinking water facilities so that all workers have easy access to them.
2. Ensure that the drinking water is clean and hygienic. Water from public water supply systems may need to be boiled, whereas rainwater and underground water often have to be filtered. Drinking water should be boiled for at least 1 minute. Pour it into a clean bottle or container, cork it firmly, and keep it cool or in a shaded place.
3. Provide hot drinks for workers working in a cold environment.
4. Keep the water containers in cool, safe and hygienic places. The water in the container must be changed frequently.
5. Provide separate cups for all workers. Wash them regularly and store them in a clean place. In some countries, drinking without touching the tap, cup or bottle is common.
6. Keep drinking water away from the chemical sources at the construction site to prevent contamination.
7. When containers or filters are used, clean them regularly.

Ways to promote cooperation

Promote cooperation to ensure that drinking water is safe. Select places for drinking water facilities that are convenient for all workers on the construction site. When construction workers work hard, they often

forget their need for regular water intake. This is dangerous, especially when they are working in a hot environment or cold conditions. Have regular breaks together and drink water. This habit will help to keep workers healthy and productive.

Some more hints

1. Workers working in a hot environment prefer cold drinking water. Keep the water in a cool place.
2. Construction workers engaged in heavy work, such as carrying heavy loads or working in the heat of the sun, need larger amounts of drinking water.
3. Beer and other alcoholic beverages can lower attention and consequently increase the risk of accidents. They should be forbidden before and during work. They cannot be a substitute for water.

Points to remember

All construction workers should have easy access to safe drinking water.



Figure 27.1. All workers on the construction site should have easy access to safe drinking facilities.

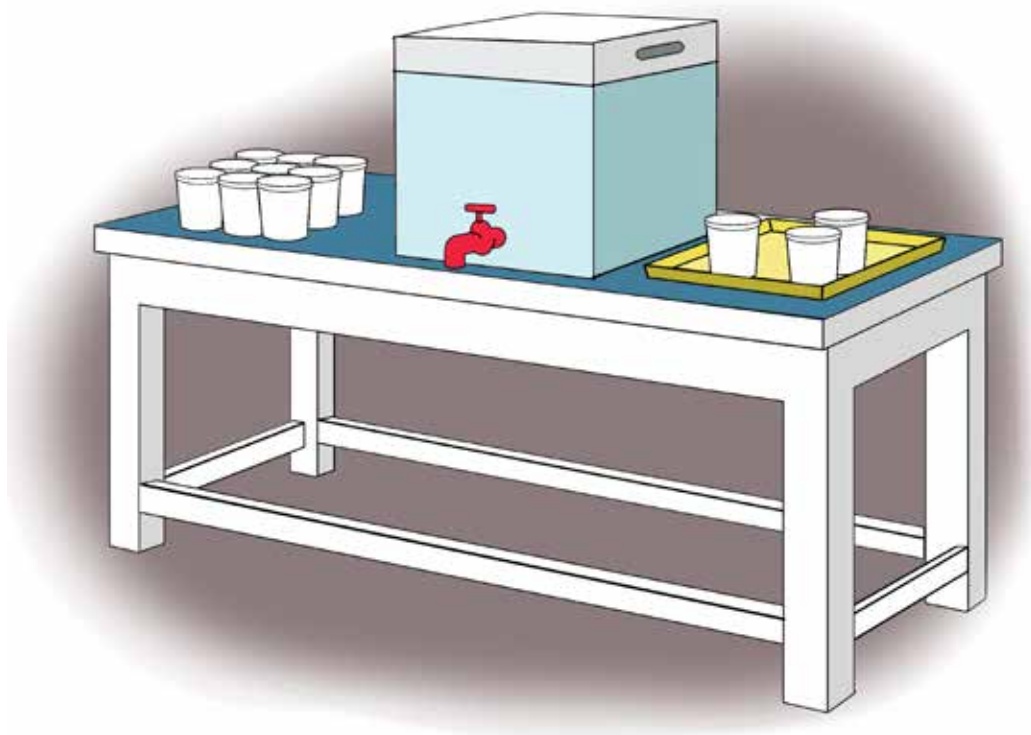

Figure 27.2. Use a convenient, low-cost facility to provide safe drinking water to all workers.

Checkpoint 28

Provide separate, clean male and female toilets, and washing facilities, close to the work area.

Benefits

Clean toilets and washing facilities are a prerequisite for creating a hygienic and comfortable working environment for construction workers. Separate toilets should be provided for women and men and should be located close to, but a little isolated from, the work area for comfortable access by all workers. Some workers might refrain from drinking water if they do not have separate and proper toilets.

Washing facilities are equally important for construction workers. They need to wash their hands and bodies during and after work to ensure hygiene, especially when handling chemicals and other hazardous materials. This practice is important to avoid skin problems and to prevent workers eating meals with contaminated hands.

How to improve

1. Build toilet facilities easily accessible to all workers on different parts of the construction site. Provide a sufficient number of toilets for convenience, at least one fully-equipped toilet for every 20 workers.
2. Prepare separate toilet facilities for women and men.
3. Equip the toilet with a water container, toilet paper, a garbage bin with a cover, a brush and soap. Clean the toilet every day to keep flies away.
4. Make hand washing a healthy habit after using the toilet. Provide soap in the washing facilities.

Ways to promote cooperation

Washing and bathing habits reduce the risk of workers being contaminated by chemicals and other hazard sources. Promote such habits among all workers. Cleaning toilets is also essential to maintaining a hygienic workplace. Make a plan to clean the toilet and washing facilities. This practice is of the utmost importance.

Some more hints

1. Pay special attention to the needs of women workers so that they have easy and comfortable access to toilets. They should not refrain from drinking water and consequently from urinating, as this might cause

dehydration and a urinary tract infection.

2. Consider installing an emergency shower to wash dangerous chemicals off the skin if a worker is accidentally exposed to chemicals.
3. Properly dispose of the wastewater from the toilets and washing facilities. It should not pollute the environment. An appropriate drainage and/or collection system should be installed.

Points to remember

Sanitary toilets and washing facilities are essential for the health of construction workers.



Figure 28.1. Provide separate hygienic toilets for women and men, as well as washing facilities, including paper towels.



Figure 28.2. Provide a sufficient number of washing facilities for the convenience of all workers.

Checkpoint 29

Provide workers with meal areas and other welfare facilities.

Benefits

Hygienic and comfortable eating areas make mealtimes more pleasant. Workers and others at the site can converse with each other, and be refreshed and ready for their next work period. Comfortable eating facilities like a canteen can be made at low-cost by using local materials and simple designs. These facilities allow workers to have their meals away from their workstations, thereby avoiding any contact with dirt, dust or dangerous substances used during the work process.

A number of other welfare facilities can also contribute to safer and more productive workplaces. Comfortable rest areas ensure that workers have a place to go where they can recuperate if they are suffering from fatigue. Workers feel more comfortable if they have lockers with keys to keep their valuables while working; and women workers may be able to take advantage of employment opportunities if there are crèches at the workplace that take care of their young children. Available spaces may be used to create simple recreation facilities, which make rest breaks more pleasant. Adequate exercise promotes workers' health and also good teamwork.

How to improve

1. Provide meal areas that are separate from the workstations. These areas should include a small space where workers can prepare drinks or heat their food.
2. Plan for a simple rest area near the workstations. Provide a water facility, as well as a table and chairs, so that workers can sit and enjoy their tea or coffee.
3. Discuss and identify the need for other welfare facilities such as lockers with keys, parking areas for bicycles and motorcycles, or simple recreational facilities. Secure spaces for selected facilities and build them step-by-step.

Ways to promote cooperation

Workers should cooperate to find adequate spaces for resting and eating areas. Some spaces may be combined to provide for both a meal and a rest area, where workers can enjoy a pleasant conversation. These areas can also be used for meetings or recreational activities. Such activities will help to keep construction workers healthy and also contribute to their teamwork.

Some more hints

1. Equip a shaded rest area with a hammock, mat and bed for lying down. A short nap after lunch helps workers stay alert for the next work period.
2. Find low-cost sports items such as balls, goals and nets. Board games, magazines and books are also suitable for pleasant rest areas.
3. Even during busy working periods, workers should maintain good eating and resting habits. Three regular meals a day are necessary for construction workers.

Points to remember

Comfortable meal and rest areas help workers recover from fatigue, strengthen team work and promote safety.



Figure 29.1. Comfortable meal areas separate from the workplace help to refresh workers. They can also enjoy conversing with each other, thereby strengthening friendships and teamwork.

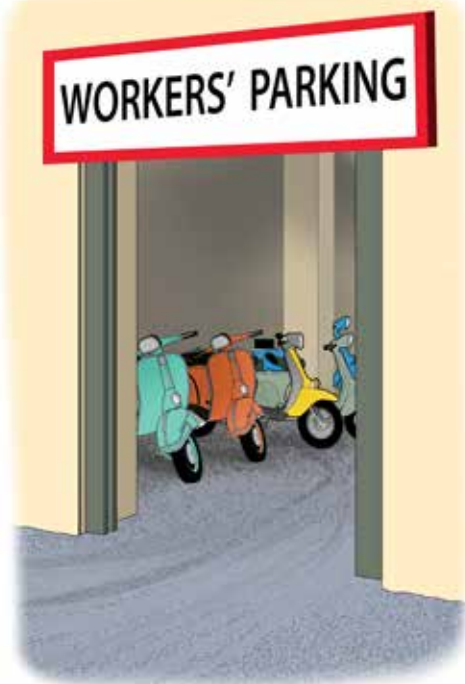

Figure 29.3. Separate parking places are recommended for workers because their bicycles and motorcycles are precious to them. They need to keep their vehicles in a good and safe condition.



Figure 29.2. Workers feel more comfortable having their own lockers with keys to keep their belongings safe.

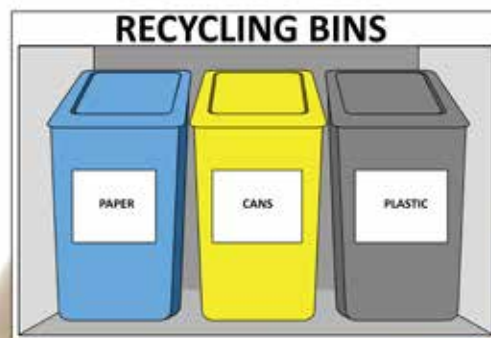

Figure 29.4. Separate recycling bins to collect waste promote a clean and comfortable working environment.

► Checkpoint 30

Provide comfortable accommodation facilities for workers.

Benefits

It is of the utmost importance to provide appropriate and comfortable accommodation facilities for workers who need to stay overnight on the construction site. They must be able to rest and recuperate in comfort to after the end of each workday. As a result, they will be more likely to work safely and increase their productivity on the following day.

Accommodation facilities should at least be offered to all workers who live far from the construction site and who have to travel far to get to work. Hygienic and well-equipped sanitary facilities, including showers, should be integrated in the accommodation facilities or as an annex.

How to improve

1. Accommodation facilities should be located in an area within or close to the construction site, thus allowing the workers to rest. They should also be near to - and have covered access to - the sanitary facilities.
2. Design these accommodation facilities to ensure good hygienic conditions and sufficient space for each worker.
3. Provide adequate natural ventilation and a good source of illumination from the windows.
4. Artificial illumination, preferably electric, should also be provided.

Ways to promote cooperation

Employers and workers should discuss jointly the best location for these accommodation facilities on the construction site. Workers should also be invited to comment on the specific equipment required for these facilities, such as mirrors, towels and carpets (depending on the surface of the floor). When using these facilities, workers should work together to improve them and keep them clean and tidy.

Some more hints

1. The covering of the accommodation's external walls should incorporate adequate thermal and acoustic insulation. The floor should be made of materials that can be easily washed.

2. In regions where mosquitos and other insects proliferate, provide mosquito screens for windows.

3. Accommodation facilities should be equipped with a sufficient number of fire extinguishers.

4. Where there is more than one bed in each sleeping quarter, make sure that each bed is at least one metre apart.

5. Where bunk beds are used, they should be limited to two beds and the space between them should be at least 1.5 m.

Points to remember

Appropriate and comfortable accommodation facilities for workers who stay overnight on the construction site will contribute towards making them work more safely and increase productivity.



Figure 30.1. A typical example of a prefabricated accommodation facility for a construction site, including an example of an internal layout. It includes a sanitary facility for night use, but no showers.



Figure 30.2. A typical example of a prefabricated sanitary facility for a construction site, including an example of an internal layout. This example includes showers and may be used as an annex to the accommodation facility, or be separate for workers who do not stay overnight on the construction site.

Checkpoint 31

Ensure that first-aid facilities are available.

Benefits

All possible measures should be taken to avoid accidents on a construction site. However, due to the nature of the construction industry, some injuries are inevitable, and the construction site should be prepared to face these eventualities.

It is therefore very important to provide every construction site with first-aid kits and ensure that all workers have easy access to them. At least one worker on site should know how to provide first aid.

The aim of first-aid kits and facilities is to save workers' lives during the first moments after an accident, prevent the injury from becoming worse, and promote recovery.

How to improve

1. Prepare a written first-aid procedure, detailing the arrangements to ensure that workers are assisted quickly in the event of an accident or illness.
2. Provide first-aid kits/boxes with clear instructions. Portable first-aid kits should also be available.
3. Train first-aid personnel (rescuers). The number of personnel trained should be based on the premise that any worker on the site should be able to receive help without delay.
4. Post a list of emergency telephone numbers in a place that is accessible and visible to all workers (posting this list in different places is recommended).

Ways to promote cooperation

It is vital to train workers in first aid, and their number will vary according to the location of the different teams on the construction site. Workers should be encouraged to cooperate in the training to become first-aid rescuers. They should also be invited to advise on the written first-aid procedure, as well as to take part in any mock accident drills on the construction site.

Some more hints

1. Ensure that first-aid kits include, for example: assorted bandages; adhesive tape; an antibiotic ointment pouch; antiseptic wipes; sterile eye pads; pointed plastic forceps; sterile gauze pads; instant

cold pack; a pair of synthetic medical gloves; a pair of angled scissors; sting relief wipes; sterile trauma pads.

2. Check the contents of the kits periodically and, where necessary, replace old kits with new ones.

3. Make transport available to access medical treatment (e.g. hospital) in the event of an emergency.

Points to remember

It is vitally important to equip all construction sites of any size with first-aid kits. It is the employer's responsibility to ensure that every worker is assisted immediately in the event of an accident.

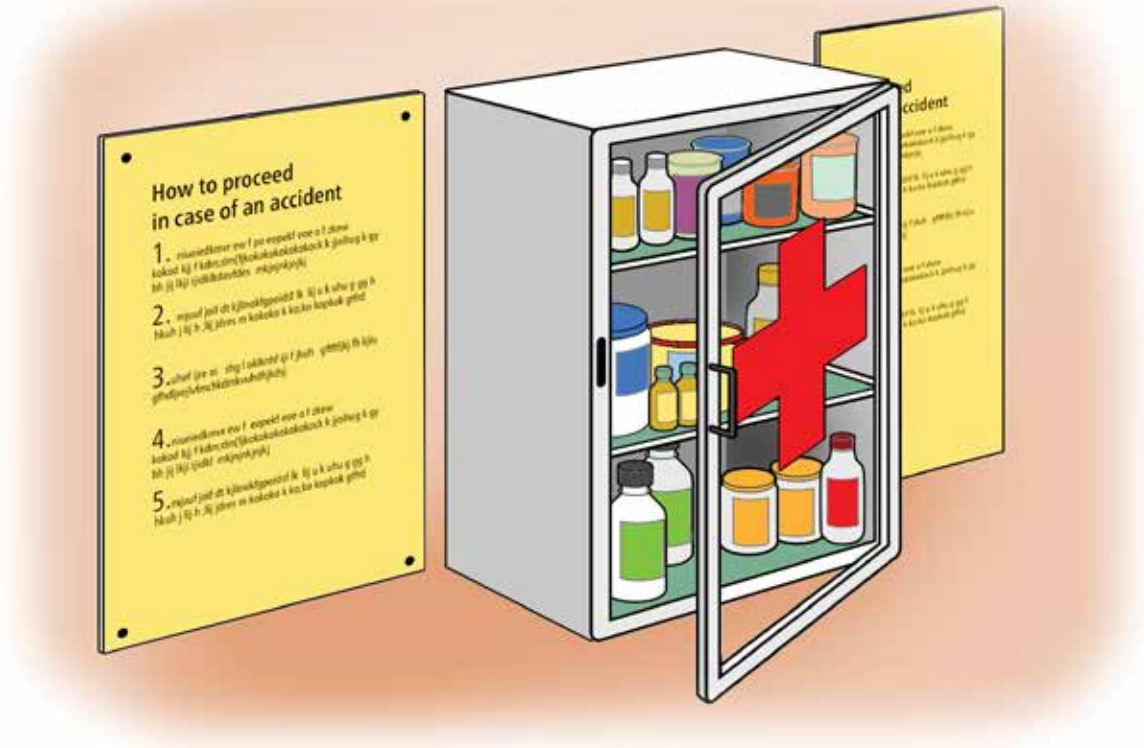

Figure 31.1. First-aid kits should be available to all workers to ensure that they receive immediate treatment in the event of an accident.



Figure 31.2. Portable first-aid kits should also be available to assist workers in an emergency at their workplace.

▶ Checkpoint 32

Promote hygienic practices to prevent infectious diseases.

Benefits

Workers on small construction sites need to be protected from a pandemic, seasonal flu and other infectious diseases. Infectious diseases are easily transmitted from one worker to another if proper action is not taken, resulting in many workers suffering from severe symptoms such as a cough, fever and sore throat. This situation has a potentially serious impact on the overall progress of the construction work.

Many steps can be taken on the construction site to reduce the risk of a pandemic, as well as seasonal infectious diseases. In a pandemic, reducing direct human-to-human contact in the work process is effective in reducing the risk of infection. It is important to promote workplace hygiene habits, such as hand washing or cough etiquette.

How to improve

1. Promote workplace practices applying to all workers, such as regular hand washing - especially before commencing work, before and after eating, and after each work break. Workers should be encouraged to use soap to clean their palms, fingers, wrists, and the backs of both hands.
2. Increase the number of hand washing sinks with soap near the workplace, which can be easily accessed by all workers.
3. Equip workers with the means to maintain hygienic workplaces, wash their hands and, if required, wear masks appropriately.
4. In a pandemic, provide adequate masks for workers and encourage them to wear a mask at the workplace and also when they are outside, especially if they work closely to one another.
5. An appropriate distance should be kept from each other: 2 m is desirable. Promote the one-way use of staircases and paths as much as possible to reduce human-to-human contact.

Ways to promote cooperation

Invite and listen to workers' ideas on ways to keep physical distance between workers and reduce infection risks at the construction site. They have a wealth of practical ideas since they are familiar with

their workplace and work procedures. Consultation processes will also strengthen cooperation between employers and workers. Preparation for a pandemic and seasonal flu will provide a good role model for other small construction sites.

Some more hints

1. Tell the workers not to come to work if they have a cough, fever, headache and other flu symptoms, or if they are sneezing, especially when there is the risk of a pandemic.
2. Select masks that fit the face of each worker. Space between the mask and the face causes air leakage and reduces the effectiveness of the mask.

Points to remember

Personal hygiene habits such as hand washing protect workers on the construction site from infectious diseases.



Figure 32.1. Establish a workplace practice that all workers should wash their hands carefully. Soap should be used to clean the palms, fingers, and backs of both hands.



Figure 32.2. Wear masks if there is a pandemic. The mask should fit your face and there should be no air leakage between your face and the mask.



Figure 32.3. If you have no disposable handkerchief, sneeze or cough into your elbow and not your hand. This will reduce the spread of germs.



Chapter 7

Work organisation and training

(Checkpoints 33 - 34)

▶ Checkpoint 33

Ensure that workers have sufficient rest time to recover from fatigue.

Benefits

Construction workers should have an appropriate work schedule that avoids long hours of work without a break to ensure their safety and health. A well-organized work schedule at the construction site prevents over-fatigue and makes work safer and more efficient. Frequent short breaks are important, as long hours of work without stopping cause over-fatigue.

Every worker needs a regular weekly rest as well as seasonal long holidays, such as the New Year break. These are particularly important to their family lives and good work-life balance. A weekly rest and holidays enable construction workers to return to work with a fresh attitude, and to work more actively and safely.

How to improve

1. Allow workers to take frequent short breaks. This is especially helpful for those workers engaged in heavy work such as carrying loads, or working in the heat of the sun.
2. Envisage short breaks lasting for around 15 - 20 minutes, depending on the workload. Take longer breaks for lunch.
3. Put in place regular weekly rest periods and adjust the work schedule for this purpose.
4. Working time per day should not exceed around 8 hours. Include a lunch break and at least two short breaks, one in the morning and another in the afternoon.
5. National holidays and seasonal holidays should also be holidays for construction workers.

Ways to promote cooperation

Build and implement a habit of short breaks on the construction site. Diligent workers might feel reluctant to take frequent breaks. Learn from the good examples of workers who have established the habit of taking proper breaks. As a result, they are more efficient and enjoy a higher level of safety and health in their work. This practice will consolidate workplace cooperation.

Some more hints

1. Pay attention to seasonal and climatic changes when

establishing work schedules. For example, work may be more difficult in summer or in the rainy seasons.

2. Set aside five to ten minutes for morning physical exercises before starting work. Warming up muscles before work might help to avoid back injuries.

3. Allow workers to take sick leave when they are injured or sick. Working before they are fully recovered might exacerbate the problem and increase the risk of occupational accidents.

Points to remember

Frequent short breaks help construction workers to recover from fatigue and enable them to work more safely and efficiently.



Figure 33.1. Frequent short breaks facilitate recovery from fatigue.



Figure 33.2. Set aside five to ten minutes for morning physical exercises before starting work.



Figure 33.3. Smoking is not recommended for health and safety reasons. However, if necessary, a smoking area should be established on the construction site, and smoking should only be allowed there.

► Checkpoint 34

Ensure that all workers have training in ways to prevent accidents and diseases.

Benefits

Construction workers need practical training to improve safety and health at work. Trained workers know how to reduce risks in their construction work and prevent occupational accidents and diseases, and are also more efficient workers.

Throughout their training, construction workers can learn about possible safety and health risks inherent in their work, as well as ways to take protective measures and use PPE. It is equally important that trainee workers visit real construction sites and see how experienced workers work safely and efficiently. They should also learn how to cooperate with other workers.

How to improve

1. Experienced workers on small construction sites should be involved in training newcomers in practical safety and health practices. Use this WISCON manual to provide practical information on ways to work safely and stay healthy. Take new workers to actual construction sites and let them see how experienced workers perform their work safely.

2. Workers should be trained to report accidents and near-miss incidents to their employers immediately, so that employers can swiftly implement improvements.

3. Train and encourage workers to discuss their accident experiences to avoid a repetition of the same accidents.

Ways to promote cooperation

Training should avoid one-way teaching and promote interactive discussions between trainers and trainees. Trainers and experienced workers should collect and use local good examples of safe construction work in their training sessions. Training should apply group work methods to encourage trainees to identify safety and health risks and propose improvements.

Some more hints

1. Experienced workers can also learn from newcomers as they come with fresh eyes to look at existing conditions in construction work. Ask them about ideas for improvements.

2. Training is a continuous process. Plan for follow-up training opportunities.

3. Whenever there is a change in work methods, workers should be trained in these new methods and informed about the new hazards involved and risk prevention measures.

4. Encourage trained workers to share the information they obtain from training sessions with other workers.

5. Plan to establish an on-site occupational safety and health committee. The committee can regularly discuss safety and health improvements for the construction site, as well as plan the necessary training for workers.

6. If there are foreign workers on the construction site who do not understand the local language, organize separate training sessions for these groups of workers in their own language.

Points to remember

Training is an effective way of gathering ideas from workers and improving safety and health.



Figure 34.1. Training should be practical. Take trainee workers to a real construction site and help them use the action checklist of this manual (WISCON).



Figure 34.2. Practical safety and health training for workers on small construction sites can be organized on site. Use good example illustrations and the checklist included in this WISCON manual as training materials.



Figure 34.3. Workers should be trained to immediately report accidents and near-miss incidents to their employers so that preventive actions can be taken.



Chapter 8

Other safe work procedures

(Excavation and demolition work)

(Checkpoints 35 - 36)

▶ Checkpoint 35

Work safely in trench excavations.

Benefits

Working in trenches is very dangerous, especially in those deeper than the shoulder height of the workers involved. Workers are exposed to the risk of burial under earth falls, one of the main causes of fatal accidents in many countries, especially during rainy seasons.

Before entering any trench, attention should be paid to the measures taken to prevent this high risk of burial. If the soil is not rock, one of the following methods should be selected: sloping or shoring the walls of the trench. This is the employer's responsibility.

How to improve

1. Analyse the conditions of the soil and decide which measure should be implemented to prevent the walls of the trench from collapsing.
2. Protect the boundaries of the excavation by building a guard-rail and/or adequate kerb stones to prevent workers and equipment from falling into the trench.
3. Store products, including those used in the excavations, at a safe distance (e.g. a minimum 1 m) from the top edge of the trench.
4. Consider the means of access into and out of the trench, such as ladders spaced at a minimum of 10 m apart.

Ways to promote cooperation

The safety of slopes in excavation work depends on the type of soil, the soil conditions (e.g. disaggregation, content of water) and existing overloads (e.g. nearby machinery). Experienced workers may participate in the decision about what constitutes an adequate slope (angle of repose, i.e. the natural slope of the soil) for each case.

Before starting the excavation work, listen to the workers' ideas about the adequacy of the slope. They are the most affected in the event of a collapse, and they should be allowed to express their opinions.

Some more hints

1. Avoid excavating long lengths of trenches that have been opened for some time; coordinate the rate of

opening the trench with the rate of placing the materials (e.g. pipes) and fill the trench immediately.

2. When rain is expected on the following days, keep the slopes covered with plastic to prevent the excavation wall from collapsing.

3. Whenever a shoring method is envisaged, the employer should have a specific design prepared by a qualified engineer, or use a prefabricated shoring system following the manufacturer's instructions.

4. Pay special attention to the behaviour of the soil when compacting the bottom of the trench, as the vibrations may destabilize the soil causing a collapse of the trench wall.

Points to remember

All non-rock trenches should provide for adequate sloping, shoring or shielding. The employer should decide which of these methods to use to ensure that workers can work safely in excavations.



Figure 35.1. A typical trench designed to prevent the excavation walls from collapsing.

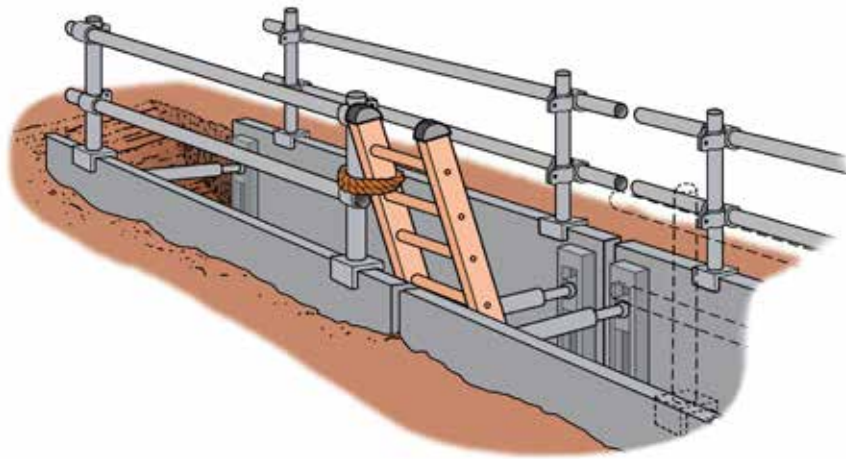

Figure 35.2. A trench box (extending out of the trench to prevent material falling into the trench) with guard-rails.



Figure 35.3. A safe installation of the trench box by machine.

▶ Checkpoint 36

Ensure the planned and safe demolition of buildings and structures.

Benefits

The demolition of buildings and structures may be carried out using different methods, including manual demolition, mechanical demolition (by using mechanical equipment or a metallic ball attached to a crane), demolition by explosives, and deconstruction.

On small construction sites, the most commonly used methods are manual and mechanical demolition by using equipment (e.g. a backhoe). Of these two methods, manual demolition using tools such as manual and pneumatic hammers is of a higher risk to workers; it is more labour-intensive and workers are therefore exposed to hazards for a greater length of time. Nonetheless, it is the most commonly used method for small demolition jobs. Priority should therefore be given as much as possible to the use of mechanical equipment.

In any of these methods, demolition should be conducted in the reverse order to construction - starting from the roof in the case of a building. Workers should receive detailed instructions on the demolition plan and use appropriate personal protective equipment to reduce the high risks to which they are exposed.

How to improve

1. Obtain information on the environmental requirements (e.g. waste disposal).
2. Conduct a thorough inspection of the site and surroundings (e.g. electric lines, gas pipes, water and sewage pipes). Identify potential risks to persons and property (e.g. effects of dust, noise, and vibrations).
3. Analyse the construction to be demolished, namely its structural characteristics, the type and stability of its roofs, the type and thickness of its walls, and any hazardous materials in the building (e.g. asbestos).
4. Based on this information, prepare the demolition plan which should include, where applicable, the method of demolition, materials and equipment required, insurance liability coverage, safety rules to be followed, restricted areas and waste disposal.

Ways to promote cooperation

All measures referred to in the preceding paragraph are the employer's responsibility. However, workers experienced in demolition know the high risks involved and good risk prevention measures, and they should be given the opportunity to advise on these specific measures. Before starting on this hazardous work, invite workers to comment on the demolition plan.

Some more hints

1. Involve workers experienced in demolition works. More detailed instructions on risks and specific risk prevention measures will be required if an inexperienced worker has to take part in the demolition work.
2. As much as possible, use adequate mechanical means for the demolition process.
3. Before starting the demolition work, dismantle selective materials to be used again (e.g. appliances, doors, windows, stones, steel), recycling (e.g. bricks, concrete) or waste management (e.g. wood).

Points to remember

Demolition works should be conducted in the reverse order to construction and, as much as possible, using mechanical means.



Figure 36.1. A scaffold platform from which demolition may be carried out safely. Manual demolition should be planned before starting the work. Workers should receive detailed instructions on the working process, as well as the hazards and risk prevention measures.



Figure 36.2. Mechanical demolition using an excavator is safer than manual demolition. Mechanical demolition requires adequate protection measures against falling objects.

A series of 25 horizontal dotted lines spanning the width of the page, intended for writing.



WISCON (Work Improvement For Small Construction Sites) Manual

The WISCON manual is designed to help employers and workers in small construction sites create safe, healthy and efficient workplaces. In this manual, employers and workers will find many practical ideas, accompanied by coloured illustrations, on ways to improve key aspects of safety, health and efficiencies such as site planning and layout, work at height, the safe use of machinery and electricity, materials handling and storage, the physical environment, welfare facilities, work organization and training, and other safe work procedures. The manual focuses on providing easy-to-apply and low-cost solutions using locally-available materials. Its methodology also sets out to promote collaborative action between employers and workers to implement these practical measures on their construction sites.

This manual draws upon the ILO's 30 years' experience of participatory action-oriented approaches to improving safety, health and efficiencies, and incorporates the knowledge it has acquired on the good practices used in various construction sites. Many employers and workers in small construction sites will find this manual useful in practice.



ILO DWT for South Asia and Country Office for India
Core 4B, 3rd Floor, India Habitat Centre
Lodhi Road, New Delhi - 110003, India
T: +91 11 4750 9200
E: delhi@ilo.org

