



International
Labour
Office
Geneva



International
Ergonomics
Association

ERGONOMIC CHECKPOINTS IN AGRICULTURE

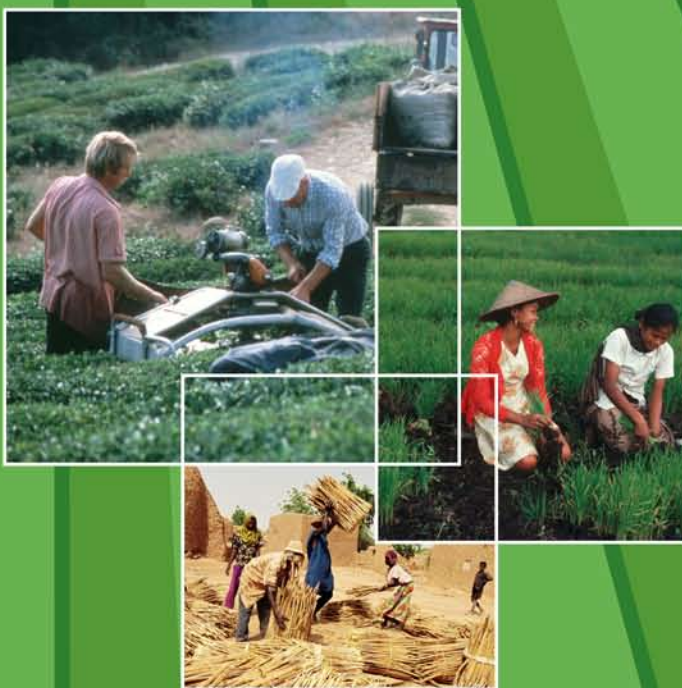

Prepared by the International Labour Office
in collaboration with
the International Ergonomics Association

Ergonomic checkpoints in agriculture

Ergonomic checkpoints in agriculture

**Practical and easy-to-implement solutions for improving
safety, health and working conditions in agriculture**

Prepared by the International Labour Office
in collaboration with the International Ergonomics Association

Copyright © International Labour Organization 2012

Publications of the International Labour Office enjoy copyright under Protocol 2 of the Universal Copyright Convention. Nevertheless, short excerpts from them may be reproduced without authorization, on condition that the source is indicated. For rights of reproduction or translation, application should be made to ILO Publications (Rights and Permissions), International Labour Office, CH-1211 Geneva 22, Switzerland, or by email: pubdroit@ilo.org. The International Labour Office welcomes such applications.

Libraries, institutions and other users registered with reproduction rights organizations may make copies in accordance with the licences issued to them for this purpose. Visit www.ifro.org to find the reproduction rights organization in your country.

International Labour Office, in collaboration with International Ergonomics Association
Ergonomic checkpoints in agriculture: Practical and easy-to-implement solutions for improving safety, health and working conditions in agriculture
Geneva, International Labour Office, 2012

occupational safety / occupational health / working conditions / work environment / ergonomics / agricultural worker / agricultural equipment / toxic substances / environmental protection / family / community participation / hours of work / work organization / agriculture

13.04.2

1 v.

ISBN 978-92-2-125448-5 (print)

ISBN 978-92-2-125449-2 (web pdf)

ILO Cataloguing in Publication Data

The designations employed in ILO publications, which are in conformity with United Nations practice, and the presentation of material therein do not imply the expression of any opinion whatsoever on the part of the International Labour Office concerning the legal status of any country, area or territory or of its authorities, or concerning the delimitation of its frontiers.

The responsibility for opinions expressed in signed articles, studies and other contributions rests solely with their authors, and publication does not constitute an endorsement by the International Labour Office of the opinions expressed in them.

Reference to names of firms and commercial products and processes does not imply their endorsement by the International Labour Office, and any failure to mention a particular firm, commercial product or process is not a sign of disapproval.

ILO publications and electronic products can be obtained through major booksellers or ILO local offices in many countries, or direct from ILO Publications, International Labour Office, CH-1211 Geneva 22, Switzerland. Catalogues or lists of new publications are available free of charge from the above address, or by email: pubvente@ilo.org

Visit our website: www.ilo.org/publns

Foreword

Agriculture is one of the most hazardous sectors in both the developing and the developed worlds. Increasing attention is being drawn to the application of practical actions in rural and agricultural settings to help reduce work-related accidents and illness, improve living conditions and increase productivity. Many effective and feasible ergonomic modifications in improving living and working conditions have been introduced in many countries. The International Labour Office (ILO) and the International Ergonomics Association (IEA) have collaborated over the years in the collection of typical practical improvements reflecting basic ergonomic principles achieved in agricultural and rural settings, particularly in developing countries. A group of ergonomics experts from both developed and developing countries convened by the ILO and the IEA compiled and reviewed examples of practical improvements and produced this manual. The know-how embodied in these examples, based on locally achieved ergonomic applications, will be extremely useful in increasing productivity and in reducing injuries and illness.

The checkpoints in this manual focus on ergonomically designed tools, on materials-handling techniques and on arrangements of workstations, the physical environment, welfare facilities, teamwork methods and community cooperation. The validity of these practical solutions has been confirmed through ILO activities in many developing countries in Africa, Asia, Central Asia and Latin America. It is encouraging that the use of action-oriented tools such as checklists referring to readily applicable ergonomic checkpoints can lead to concrete improvements in agricultural workplace and rural settings.

The design and layout of this practical manual are based on experience gained in the production

of *Ergonomic checkpoints*, previously published by the ILO, and on the expertise of the contributing experts and collaborators. The manual covers the most fundamental ergonomic principles in agriculture and rural settings, which can easily be adapted to different situations. The 100 checkpoints here are examples of practical ergonomic interventions that can be achieved at low or no cost in agricultural and rural settings and are particularly applicable in developing countries. Practical examples are provided in the illustrations attached to each checkpoint.

The publication of this manual is intended to make these effective, locally achieved improvements known globally, so that others can learn from them. It is expected that they will be used as training tools, or as practical solutions to address common problems in the agricultural workplaces and rural settings of today's world. The concrete and practical guidance on easy-to-implement ergonomic improvements presented here will help people to adopt good work practices in agricultural and rural settings in a systematic manner. Participatory approaches directly involving farmers are the key for application of the ergonomic solutions in this manual. I believe that it will be a valuable tool for people in many countries to improve productivity and reduce injuries and illness in the agricultural workplace and in rural settings.

Seiji Machida
Director
Programme on Safety and Health
at Work and the Environment (SafeWork)
International Labour Office

Preface

This manual, compiled jointly by a group of international experts assembled by the International Ergonomics Association (IEA) and the International Labour Office (ILO), presents practical solutions for improvements in agricultural work and rural life from an ergonomics point of view. The checkpoints it lists are intended to be used as a means to improve existing working and living conditions, for better safety, health and efficiency in agricultural and rural settings.

The “Ergonomic checklist for agriculture” summarizes the core actions, and can be used as a starting point for designing a checklist adapted to a particular workplace. The contents and use of such a checklist are described in “Suggestions for using the manual”. Examples of the application of selected items from the checkpoints are described in the annexes to this manual.

It is recommended that this manual be used for assessing existing working conditions from an ergonomics viewpoint, and for implementing effective improvements in different situations.

Ergonomic checkpoints in agriculture was initially applied in Viet Nam to promote a participatory, action-oriented training approach for farmers which takes account of the methodology promoted by the ILO training programme Work Improvement in Neighbourhood Development (WIND). This methodology was first used in farms in Cantho, Viet Nam, by the Centre for Occupational Health and Environment of the Health Department of Cantho Province, Viet Nam, and the Institute for Science of Labour in Kawasaki, Japan. The basic principles of the WIND methods reflect the ILO training approach known as Work Improvement in Small Enterprises (WISE). The ILO WISE approach has led to numerous workplace improvements in many developing countries. The ILO has launched WIND programmes in several developing countries, and these programmes have been effective in small-scale and micro farms and rural settings of these countries.

Ergonomic checkpoints in agriculture is the result of close collaboration between the IEA and the ILO. Experts from both industrially developing and developed countries worked together to realize this collaboration.

The IEA task group that compiled the preliminary *Ergonomic checkpoints in agriculture*, based on good ergonomic practices in agricultural work and rural

settings in both developing and developed countries, consisted of the following:

- David Caple, International Ergonomics Association, Australia (co-coordinator);
- Kazutaka Kogi, Institute for Science of Labour, Japan (co-coordinator);
- Sara Arphorn, Mahidol University, Thailand;
- Tsuyoshi Kawakami, ILO Subregional Office for East Asia, Thailand;
- Ton That Khai, Cantho Medical College, Viet Nam;
- Yutaka Kikuchi, Bio-oriented Technology Research Advancement Institution, Japan;
- Kurt Landau, Darmstadt University of Technology, Germany;
- Adnyana Manuaba, Udayana University, Indonesia.

The initial manuscripts for this manual were drafted by Kazutaka Kogi, Tsuyoshi Kawakami and Ton That Khai in consultation with the other members of the group. Illustrations showing examples of improvements achieved by applying the ergonomic principles corresponding to each of the compiled checkpoints were drawn by Nguyen Thi Sam in Viet Nam in collaboration with Ton Thai Khai and his collaborators.

A working group on *Ergonomic checkpoints in agriculture* was organized in 2007 to examine the preliminary draft and make necessary improvements. This working group consisted of:

- Nyoman Adiputra, Udayana University, Indonesia;
- Masum Ahmad, Bangladesh Agricultural University, Bangladesh;
- Samar A. Al-Hadidi, University of Jordan, Jordan;
- Elias Apud, University of Concepción, Chile;
- Sara Arphorn, Mahidol University, Thailand;
- David Caple, International Ergonomics Association, Australia (IEA coordinator);
- Fadi Fathallah, University of California Davis, United States;
- Mohammad Ghorbani, Ferdowsi University of Mashhad, Iran;
- Tsuyoshi Kawakami, ILO Subregional Office for East Asia, Thailand;

- Ton That Khai, Cantho Medical College, Viet Nam;
- Kazutaka Kogi, Institute for Science of Labour, Japan (Chairperson of IEA drafting group);
- Wendy MacDonald, La Trobe University, Australia;
- David Moore, University of Massey, New Zealand;
- Shengli Niu, SafeWork, ILO, Switzerland (ILO coordinator);
- Enrico Occhipinti, EPM Foundation Policlinico, Italy;
- Dave O'Neill, Dave O'Neill Associates, United Kingdom;
- Atul K. Shrivastava, College of Agricultural Engineering, India;
- Suman Singh, Maharana Pratap University of Agriculture and Technology, India;
- Shuping Xiong, Hong Kong University of Science and Technology, China;
- Efi Yuliah Yovi, Bogor Agricultural University, Indonesia;
- Rosnah Mohd Yusuff, Universiti Putra Malaysia, Malaysia.

A workshop of the working group was organized in November 2007 in conjunction with the International Agricultural Ergonomics Development Conference held in Kuala Lumpur, Malaysia. During the workshop, the working group reviewed the preliminary manual and made improvements to the compiled ergonomic checkpoints. Modifications required after the workshop, with both the manuscript

and the illustrations, were implemented by Kazutaka Kogi, Tsuyoshi Kawakami and Ton That Khai in consultation with the IEA Executive Committee members and the ILO Programme on Safety and Health at Work and the Environment (SafeWork).

Along with the drafting and editing work, there have been a series of ILO and national projects using the WIND methodology to improve working conditions in agriculture. These activities include provincial and national programmes in the Philippines, Thailand and Viet Nam, and the ILO technical cooperation projects in Kyrgyzstan, Senegal, Viet Nam and Central American countries. The improvements achieved through these activities were the basis for the drafting and reviewing of this manual.

Nguiyen Thi Sam, in collaboration with Ton That Khai of Cantho Medical College in Viet Nam, prepared the new illustrations in colour.

The ILO acknowledges the contribution and support of David Caple, IEA President in 2006–09, and Andrew Imada, current IEA President, to the joint preparation of this publication. Thanks also go to the IEA Executive Committee members for both their material and their intellectual support.

Thanks are due to Sameera Maziad Al-Tuwaijri, former Director of SafeWork, and to Seiji Machida, SafeWork's current Director, for their support.

The ILO and IEA hope that this manual will serve as a practical tool for improving safety and health in agricultural work and in rural settings in many parts of the world.

Shengli Niu, Co-Editor
Coordinator, Occupational Health Cluster
Programme on Safety and Health
at Work and the Environment (SafeWork)
International Labour Office

Kazutaka Kogi, Co-Editor
Chairperson
IEA Working Group for
Ergonomic checkpoints in agriculture
International Ergonomics Association

Contents

Foreword	v
Preface	vii
Suggestions for using the manual	xi
Ergonomic checklist for agriculture ..	xvii
Storage and handling of materials	1
(checkpoints 1–14)	
Workstations and tools	31
(checkpoints 15–28)	
Machine safety	61
(checkpoints 29–40)	
Agricultural vehicles	87
(checkpoints 41–48)	
Physical environment	105
(checkpoints 49–61)	
Control of hazardous chemicals	133
(checkpoints 62–66)	
Environmental protection	145
(checkpoints 67–72)	
Welfare facilities	159
(checkpoints 73–80)	
Family and community cooperation ..	177
(checkpoints 81–88)	
Work organization and working schedules	195
(checkpoints 89–100)	
Annexes	221
Annex 1 Using <i>Ergonomic checkpoints in agriculture</i> in participatory action-oriented training	
Annex 2 Action checklist for agriculture	
Annex 3 Sample programmes for a training workshop using <i>Ergonomic checkpoints in agriculture</i>	
Annex 4 Examples of group work results	

Suggestions for using the manual

The suggestions given here for using *Ergonomic checkpoints in agriculture* are based on training experience gained in both industrially developing and developed countries. These experiences reflect the Work Improvement in Small Enterprises (WISE) methodology developed by the ILO, and similar participatory action-oriented training methods. Many members of the working group for this manual have had experience in training activities. The link with these participatory methods was maintained in the development of this manual.

Workplace improvements can benefit from application of the guidance provided in this manual. The improvement actions indicated by the individual ergonomic checkpoints are based on sound ergonomic principles that have been tested in real workplaces:

- Solutions need to be developed with the active involvement of both managers and workers.
- Group work is advantageous for planning and implementing practical improvements.
- The use of available local materials and expertise has many benefits.
- Improvement measures need to be sustainable over time.
- Actions need to be continued to create locally adjusted improvements.

The ergonomic checkpoints compiled in this manual reflect these underlying principles. They represent simple, low-cost ergonomic improvements that are readily applicable. This easy-to-implement nature is favourable for group work, and for implementation by means of local materials and skills. The checkpoints cover broad areas, and could be applied in different local situations. The illustrations after each of the 100 checkpoints show practical, low-cost ideas that have been applied in a wide variety of local conditions.

There are four main ways of using the ergonomic checkpoints compiled in this manual:

1. applying selected checkpoints to the workplace;
2. designing locally adapted, handy checklists;
3. making ready-to-use information sheets; and
4. organizing training workshops for planning and implementing immediate workplace improvements.

1. Applying selected checkpoints to the workplace

In applying ergonomic checkpoints, it is advisable to select checkpoints that are considered relevant and important for a particular workplace. Usually, around 20–30 checkpoints are adequate for an initial review of the workplace. Copies of the corresponding pages of the selected checkpoint items from this manual may be distributed for use in the initial stage of occupational safety and health and ergonomic intervention or workplace risk management. Based on the selected checkpoints from this manual, a short checklist may be formulated. If time allows, it is recommended that a local checklist adapted to the workplace be developed. Guidance in this regard is provided in the following section.

In applying these selected checkpoints, or using them for training purposes, it is useful to organize workplace walk-throughs. A short checklist can greatly help these walk-throughs, as it helps participants examine the workplaces in a systematic way and find weak points for improvement. Don't forget to ask people to find good points in existing practice, as these are helpful in subsequent discussions.

The results of the workplace visits should be discussed in small groups and then examined in a meeting of all the participants or group representatives. The group work of people using the selected checkpoints items is essential for identifying locally practicable improvements.

As indicated in the following sections, it is important to look at multiple aspects of the workplace conditions. Therefore it is advisable to select a few items from several chapters in the manual. These should cover materials storage and handling, tool and machine safety, workstation design, physical environment, welfare facilities and work organization.

A brief checklist based on the selected checkpoint items can help people prioritize immediate actions to be taken. They may choose both short-term and long-term priorities. As there are simple, low-cost actions in all these areas, it should be relatively easy to select appropriate checkpoint items by taking into account the particular conditions of the workplace concerned.

2. Designing locally adapted, handy checklists

The aim is to design and use a locally adapted checklist made up from selected checkpoints. Such a checklist can be a powerful tool for ergonomic assessment and improvement of existing conditions of work.

As the checkpoints compiled in this manual represent readily applicable workplace improvements, an “action checklist” needs to be developed as a reference for selecting checkpoints suitable to the local situation. A locally adapted checklist is usually designed in group work, as follows:

1. The main areas requiring immediate improvements should be agreed on through group work. Usually, particular aspects of materials storage and handling, machine safety, workstation design, lighting, premises, welfare facilities and work organization may be considered first.
2. It is advisable to select only a limited number of checkpoint items from the action checklist, for each of the areas targeted.
3. The selected items can be assembled into a draft checklist of about 30–50 items. These items should cover the areas chosen. This draft checklist can follow a format similar to that of the action checklist. This format (answering the question “Do you propose action?” with NO or YES, and pointing out whether the action is PRIORITY or not) is beneficial, as it helps the users propose priority improvements in the local context. The draft may be tested through pilot use, including a walk-through in a particular workplace. By obtaining feedback from this pilot test, the locally adapted checklist can be finalized.
4. The checklist can be supplemented by a brochure containing the corresponding photocopied pages of this manual. The brochure, comprising two pages each for the selected 30–50 checkpoints, can be used as reference material for low-cost local options.

This combination of a locally designed checklist and a brochure explaining the corresponding checkpoints can be used in the actual implementation of workplace improvements. The design of the checklist and the explanatory brochure can be undertaken by, for example, members of a safety and health committee, a special task group including representatives of management and trade union members, a working party consisting of workplace managers, supervisors and workers, or a special task group established for particular ergonomic action. Such groups of local people can be both the designers and the users of the checklist and the associated brochure.

The whole process of designing and utilizing a locally adapted checklist and an associated brochure may be summarized as follows:

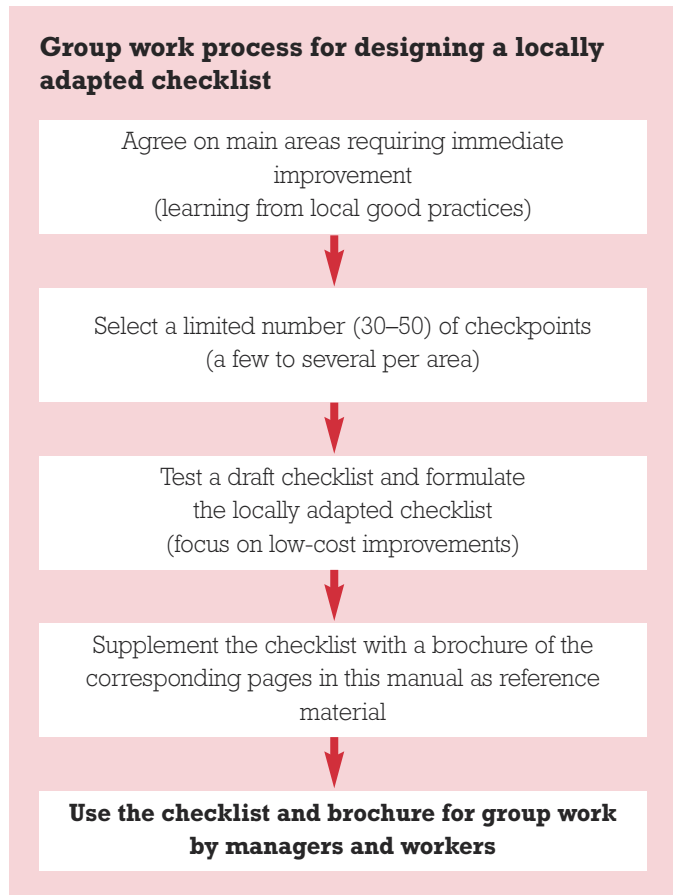

A locally adapted checklist formulated in this way is used to find locally available and practicable improvements, rather than to make a complete appraisal of the ergonomic conditions of the workplace in question. This is because it is better to make stepwise progress in improving various ergonomic aspects.

Therefore it is better to design a relatively short checklist comprising about 30–50 items, as described above, rather than formulate a lengthy checklist comprising all the relevant items in this manual. At first glance a longer checklist may appear to be more comprehensive, but in reality it is not often used actively by local people, because of its lengthy and complicated structure. A short, handy checklist is far more suited to voluntary use. By going through the short list of available ideas in multifaceted aspects, users are more inclined to look for feasible options, and thus proceed to group work on selecting priorities. This group-motivating nature of a locally adapted checklist should be kept in mind.

When some specific aspects of ergonomic conditions require particular attention, a more detailed checklist will be useful. For example, a checklist relating mainly to muscular loads might be formulated if musculoskeletal problems are the main complaints in a particular workplace. Such specific workloads are affected in various ways by many different factors, and a relatively short list can lead to lively discussion about how to deal with these.

A short version of a locally adapted action checklist for use in small enterprises, designed by a working group in Malaysia, lists 31 action items with low-cost improvement ideas. The action checklist is supplemented by a brochure explaining locally available options for each of these 31 actions, together with a typical illustration and a photograph of a good local example. For easy reference the checklist is annexed to this manual (Annex 2).

It is worthwhile exchanging sets of checklists and associated brochures in different industries and settings. A recent tendency has been to design an action checklist of 30–40 items through learning from local good examples in multiple localities and settings.

3. Making ready-to-use information sheets

This manual can be used to produce information sheets explaining practical ergonomic improvements. The simple, uniform structure of the checkpoints in the manual is beneficial for this purpose. The manual's colour illustrations are also helpful for easy use of the checkpoints as reference sheets.

There are three basic options for creating information sheets by using the checkpoint pages of this manual:

1. Single information sheets

Each individual checkpoint in the manual consists of two pages, and so any of the checkpoints can be photocopied and offered as a two-page information sheet. Depending on local needs, a set of such information sheets can also be reproduced. These sheets may be distributed to various groups of people, or used as supplementary materials for training programmes.

2. Brochure-type information sheets

Relevant checkpoints selected from the manual can be compiled as a brochure. The checkpoints to be included in the brochure may be selected by a task group. A variety of brochures can be developed. Examples are brochures containing checkpoints applicable to a particular type of workplace, or relating to a specific ergonomic aspect or

specific risk, such as manual handling, hand tools, computer workstations, muscle strain, upper limb disorders, eye strain, injury risks, heat and cold, chemical risks, work stress, preventing mistakes, emergencies, work organization or young workers.

3. Locally adapted information sheets

Another useful way of using the manual to produce information sheets is to re-edit the pages of the checkpoints by adding remarks and materials that reflect local conditions. This is relatively easy to do, as the emphasis of the manual is on simple, practical improvement options. In particular, handy brochures may be created by including good local examples achieved in line with the practical options encouraged by this manual. Brochures showing photographs of good local examples are particularly useful for small and medium enterprises in similar situations, and for particular industries or particular types of job that share similar workplace conditions and settings.

4. Organizing training workshops for immediate workplace changes

A practical way of using the manual in training in implementing workplace improvements is to organize short workshops to train local people to apply basic ergonomic principles. Various training workshops have been organized in a number of countries using the manual for this purpose.

Experience in ILO training activities and similar participatory programmes has shown the effectiveness of training workshops of one to four days, which allow sufficient time for learning about good practices by building on local experience. This manual can be used as a source of action-oriented training materials.

Such training workshops can be combined with the use of locally adapted checklists, brochures or information materials, as described above.

An action-oriented training workshop can be organized by:

1. collecting local good examples;
2. holding sessions to identify low-cost local options for improving workplace conditions;
3. going through a group work process to learn how to propose and implement practicable improvements.

The initial step – collecting local good examples – is particularly useful. These can show the range of ergonomic problems, and their locally achievable

solutions. Checklists indicating locally available options, and the corresponding pages of this manual, can be used as a tool for connecting these good practices with ergonomic improvements, and for guiding the trainees towards the immediate implementation of these improvements. Group work is essential in following these steps.

Typical participatory steps in an action-oriented training workshop using this manual may be as follows:

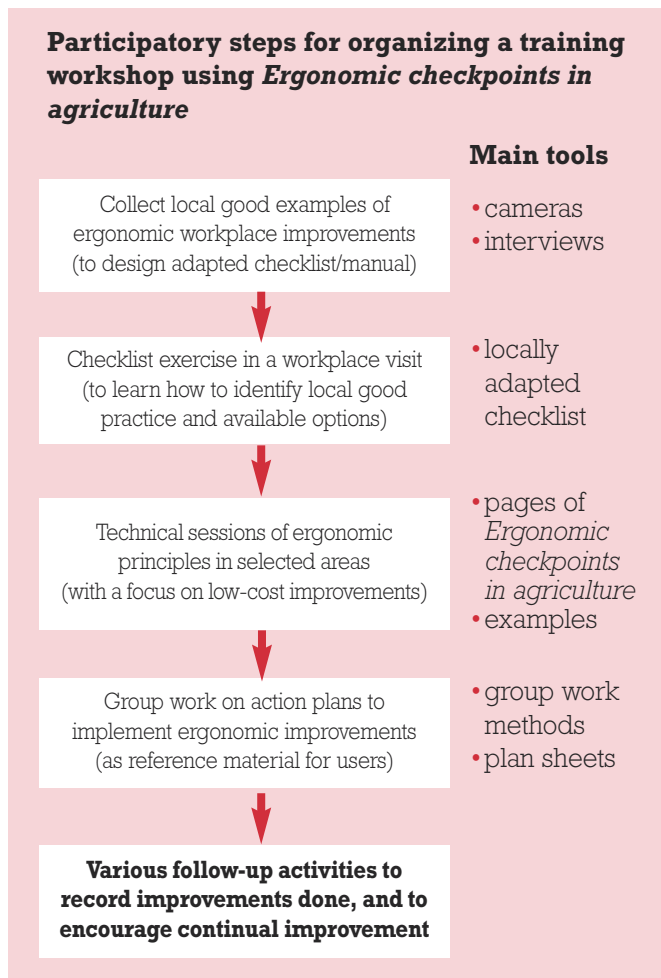

These training steps can usually be taken within one to four days. It is important to organize regular group discussion sessions. Each session (1 to 1½ hours) should consist of a presentation by a trainer, discussion in small groups, and presentation of group results. In this way, the participants can learn the practical methods for applying the checklist, and propose practicable improvements that have a real impact on the workplace.

For a one- or two-day workshop the checklist exercise may be undertaken in the morning of the first

day. This enables the participants to utilize their checklist results in subsequent training sessions on a few chosen technical areas. Experience shows that it is useful to at least have sessions on materials storage and handling, workstation design and the physical environment. In a two-day workshop, sessions on machine safety, welfare facilities and work organization may be added.

For a three- or four-day workshop the main technical areas in the manual may be covered. For example, after the checklist exercise, sessions on materials storage and handling, tool and machine safety, workstation design, lighting, physical environment, welfare facilities and work organization may be held. Studies of successful cases, and a session on how to implement practical improvements, may be added. It is useful to encourage the participants to present their own action plans.

The emphasis of all the sessions should be placed on learning from local good examples, proposing improvements that apply basic ergonomic principles, and learning group work procedures to agree on immediately practicable improvements.

Sample programmes for a one-day and a two-day workshop are given in Annex 3. These programmes are structured in the form of serial group work sessions. The commonly useful training tools comprise a locally adapted checklist, local good examples (photographs with short remarks, for example), and the corresponding pages of relevant checkpoints in this manual.

5. Practical hints for implementing improvements

Workplace improvements can be implemented by taking advantage of the action-oriented nature of this manual. There are some common practical hints in using the manual, as indicated by the above-mentioned suggestions.

It is always useful to rely on local good practice (as demonstrated by local good examples), and to take participatory group work steps. The information in this manual can help people look at available improvement options in multiple technical areas, and propose simple, low-cost improvements that are practicable in particular local conditions. The following hints may be helpful in utilizing the manual effectively:

1. Use an action checklist to take a fresh look at workplace conditions

Ergonomic checklists can help people to examine existing workplace conditions in a systematic way. The action form of check items, as indicated by the

ergonomic checklist in this manual, is a very useful guide for people to look at locally practicable improvements. A lengthy checklist is difficult to apply, and so it is advisable to design an action-form checklist that lists a limited number of low-cost options. Such a checklist will provide local people with opportunities to identify potential improvements with a fresh look.

2. Learn from good examples in local workplaces

Locally achieved examples of workplace improvements demonstrate not only their merits but also their feasibility. They provide an insight into the ways in which improvements are implemented in difficult local conditions. They can therefore encourage local people to take action on their own. Local good examples provide many useful hints for undertaking improvements in terms of workable ideas, skills, costs, materials and cooperation among managers and workers. Also, looking at achievements rather than pointing out weaknesses always helps promote positive and constructive thinking, leading to real improvements.

3. Develop improvement ideas that can work

When a new idea for improvement is proposed, it is important to make sure that it can work in the real local situation. Good examples from local workplaces can help in looking at the feasibility and practicality of each new idea. Starting from low-cost ideas is always pragmatic, as these ideas are usually feasible using local materials and skills.

4. Mobilize worker support

In making changes, it is essential to make it clear to the workers concerned that the planned changes will lead to benefits and progress, and will not adversely affect their jobs. Inform workers of the changes to be made, and explain their rationale and benefits in advance. It is also essential to provide advance training, and to consult workers about possible unintended effects. The best way to avoid resistance to change is to plan and implement it jointly with the workers concerned.

5. Make improvements that will last

A useful way to make a change that will last is to build the change into equipment or facilities; don't try to depend solely on changing people's attitudes and habits. Changes built into equipment or facilities tend to last. For example, it is always better to provide adequate means of storage and transport, rather than merely to

emphasize the need for good housekeeping. With racks, containers and mobile devices, good housekeeping practices are more likely to last and have their intended effects.

6. Always discuss in a group

Better solutions are always found by discussing multiple ideas from many people. Always discuss in a group, respecting each other's ideas and maintaining a positive stance. Group discussions also help people exchange experiences about how to prioritize actions derived from many ideas. This is because group discussions help people compare different ideas and their benefits, and reach a consensus that is beneficial to the people concerned.

7. Manage change

Technical expertise alone is not sufficient to make successful changes. It is the responsibility of local people in charge of the workplace to make the changes a success. There are certain points they should pay attention to:

- establish a firm deadline;
- assign the responsibility for implementation to someone;
- allocate adequate resources (time, materials, money, technical skills);
- request regular reports on progress;
- make sure that people who take part in the improvement process are rewarded and praised.

8. Promote both short-term and long-term improvement plans

It is best to advance improvement plans step by step. This requires priorities to be set from the viewpoints both of local needs and of feasibility in terms of costs and technical possibilities. Ideas that can meet immediate local needs should be put into practice first, on a short-term basis. Once small but effective improvements have been made, people become more confident of taking the next steps, which may need more time and resources. Thus it is always sensible to develop both short-term and long-term improvement plans.

6. Follow-up activities

Training in the use of an ergonomic checklist and information on checkpoints is not the end of improvement actions; it is just the beginning. It is

essential to make a concrete plan for follow-up activities that involve local people after the training. The purposes of follow-up activities are to:

1. see what improvements are undertaken in local conditions;
2. understand what further support is needed to continue improvements while overcoming constraints;
3. encourage continued effort by facilitating the exchange of improvement experiences.

In these follow-up activities, the action-oriented features of this manual can help organize activities in a systematic way. The various improvement options presented in the manual, and the broad scope of these options, can provide a useful basis for assessing the effectiveness of follow-up activities.

The manual can be used to organize effective follow-up activities as follows:

1. In follow-up visits

Visits to workplaces participating in the training activities provide useful opportunities for trainees to identify workplace problems, propose improvement options and know what support they need to implement improvements. A good time for such visits is a few weeks or a few months after the training workshop. It is useful to utilize follow-up sheets for workplace people to complete. The visits also provide an occasion to praise the actions taken, and encourage further efforts. The various checkpoints in the manual may be used as a reference in recording achievements and advising on continued efforts. In dealing with difficulties met at the workplace, the options in the manual are useful for discussion among managers and workers.

2. In follow-up meetings

Follow-up meetings are very useful for exchanging improvement experiences and discussing support needed. Such meetings can be organized at intervals from several to 12 months after training. It is always better to fix the date and place of the next follow-up meeting in advance. Usually, a half or whole day should be long enough for such a meeting. Its purpose is for participants to report their achievements, appreciate effective options and exchange know-how in continuing improvements. The broad areas covered, and the various hints in the manual, can be used for arranging the meeting agenda. Good examples and success stories reported can be included in training and information materials.

3. In facilitating the exchange of positive experiences

An important follow-up activity is to link the positive results gained through the training and follow-up activities with existing networking arrangements. Examples include the use of websites for disseminating positive experiences and local good examples, and the publication of newsletters and leaflets showing these examples and new ideas. The information in the manual on basic ergonomic principles and available improvement options can certainly help people focus on locally applicable, low-cost ideas.

7. Linking achievements with improvement actions

Throughout the training and information activities and the follow-up activities using the manual, it is important to link locally achieved positive experiences with proposals and plans for improvement actions. This is best done by organizing group work on different aspects of ergonomic checkpoints, as described in this manual. A good way to address the link in group work is to discuss and agree on three good points already achieved at the workplace, and three points that need to be improved. These points should be used as a basis for discussing priority actions to be taken jointly.

Local achievements should be used as a basis for developing practical, innovative ideas in the local context. The technical areas addressed in the manual are arranged according to the common types of such local achievement so as to help people explore locally practicable ideas. The discussions on good points and points to be improved thus help people look at potential improvements in the local context.

For easy reference, and to increase the usefulness of the technical categories dealt with in the manual, Annex 4 shows examples of group work results based on checklist exercises carried out by farmers in Cantho, Viet Nam.

ERGONOMIC CHECKLIST FOR AGRICULTURE

How to use the checklist

This checklist is a compilation of the titles of the ergonomic checkpoints included in this manual. There are 100 items in the list. You may use either the whole list, or your own list containing only those items relevant to your workplace. Usually, a checklist of about 30–50 items suitable for your workplace is easier to apply.

1. Knowing the workplace

Ask the farm owner any questions you have. You should know about the main products and production methods, the number of farm workers (male and female), the hours of work (including breaks and overtime) and any important labour problems.

2. Defining the work area to be checked

Define the work area to be checked in consultation with the manager and other key people. In the case of a small enterprise, the whole production area can be checked. In the case of a larger enterprise, particular work areas can be defined for separate checking.

3. Initial walk-through

Read through the checklist, then spend several or more minutes walking through the work area before you start to check, using the checklist.

4. Writing your check results

Read each item carefully. Look for a way to apply the measure. If necessary, ask the farm owner or farm workers questions.

— If the measure has already been taken properly, or if it is not needed, mark NO under “Do you propose action?”

— If you think the measure would be worthwhile, mark YES.

— Use the space under “Remarks” to add a description of your suggestion or its location.

5. Selecting priorities

After you have finished, look again at the items you have marked YES. Choose a few items where the benefits seem likely to be the most important. Mark PRIORITY for these items.

6. Group discussion about the check results

Discuss the check results jointly with other members who have taken part in the walk-through. Agree on the existing good points, and on the measures to be taken on the basis of the checklist application. Communicate with the farm owner and workers about the proposed measures, and follow up on their implementation.

Checklist

Storage and handling of materials

1. Keep transport routes clear and in good condition for the movement of people and materials.

Do you propose action?

NO YES PRIORITY

Remarks

2. Eliminate sudden height differences and holes on transport routes, and use ramps or slopes where necessary.

Do you propose action?

NO YES PRIORITY

Remarks

3. Construct sufficiently wide, stable bridges over rivers, canals and ditches.

Do you propose action?

NO YES PRIORITY

Remarks

4. Use carts, hand-trucks and other wheeled devices when carrying materials, tools and products.

Do you propose action?

NO YES PRIORITY

Remarks

5. Make sure the wheels on carts and hand-trucks are large enough to work effectively on field routes.

Do you propose action?

NO YES PRIORITY

Remarks

.....

6. Provide multi-level shelves or racks near the work area for storing materials, tools or products.

Do you propose action?

NO YES PRIORITY

Remarks

.....

7. Instead of carrying heavy weights, divide them into smaller, lightweight sacks and packages.

Do you propose action?

NO YES PRIORITY

Remarks

.....

8. Provide specially designed containers, pallets or trays of appropriate size for storing and moving materials and farm products.

Do you propose action?

NO YES PRIORITY

Remarks

.....

9. Provide good grips or holding points for all containers and packages.

Do you propose action?

NO YES PRIORITY

Remarks

.....

10. Use mobile storage racks or wheeled stands for storing and moving materials, tools and products.

Do you propose action?

NO YES PRIORITY

Remarks

.....

11. Use hoists, rollers, conveyers or other mechanical means for moving or lifting heavy materials.

Do you propose action?

NO YES PRIORITY

Remarks

.....

12. Keep objects close to the body when carrying them.

Do you propose action?

NO YES PRIORITY

Remarks

.....

13. Eliminate or minimize height differences when moving materials manually.

Do you propose action?

NO YES PRIORITY

Remarks

.....

14. Develop convenient containers or other means for collecting waste at the workplace.

Do you propose action?

NO YES PRIORITY

Remarks

.....

Workstations and tools

15. Put frequently used tools, switches and materials within easy reach.

Do you propose action?

NO YES PRIORITY

Remarks

.....

16. Provide a "home" for each tool.

Do you propose action?

NO YES PRIORITY

Remarks

.....

17. Adjust the work height so that work is done at, or slightly lower than, elbow level.

Do you propose action?

NO YES PRIORITY

Remarks

18. Change farming arrangements in the field to avoid strenuous working postures as much as possible.

Do you propose action?

NO YES PRIORITY

Remarks

19. Use jigs, clamps or other fixtures to hold items while work is being done.

Do you propose action?

NO YES PRIORITY

Remarks

20. Eliminate work at height, or provide a safe, stable platform.

Do you propose action?

NO YES PRIORITY

Remarks

21. Make switches and displays easy to distinguish from each other.

Do you propose action?

NO YES PRIORITY

Remarks

22. Choose work methods that alternate standing and sitting, and try to avoid bending and squatting as much as possible.

Do you propose action?

NO YES PRIORITY

Remarks

23. Provide stable chairs or benches of the correct height, with sturdy backrests, for seated work and for occasional sitting during standing work.

Do you propose action?

NO YES PRIORITY

Remarks

24. Choose tools that can be operated with minimum force.

Do you propose action?

NO YES PRIORITY

Remarks

25. Provide tools with appropriate grips that have adequate friction.

Do you propose action?

NO YES PRIORITY

Remarks

26. Attach labels, signs and symbols that are easy to understand, in order to avoid mistakes.

Do you propose action?

NO YES PRIORITY

Remarks

27. Provide adjustable work surfaces for workers dealing with objects of various sizes.

Do you propose action?

NO YES PRIORITY

Remarks

28. Use portable stepladders to prevent falls from unstable, elevated places.

Do you propose action?

NO YES PRIORITY

Remarks

Machine safety

29. Purchase machines that incorporate the necessary safety guards and precautions.

Do you propose action?

NO YES PRIORITY

Remarks

30. Attach proper guards to the dangerous moving parts of machines.

Do you propose action?

NO YES PRIORITY

Remarks

31. Use appropriate feeding devices to avoid danger and increase production.

Do you propose action?

NO YES PRIORITY

Remarks

32. Position machines in a stable place when using them in farm fields.

Do you propose action?

NO YES PRIORITY

Remarks

33. Work with partners to use machines, and avoid working alone whenever possible.

Do you propose action?

NO YES PRIORITY

Remarks

34. Make sure that machines are well maintained, and have no broken or faulty parts.

Do you propose action?

NO YES PRIORITY

Remarks

35. Ensure that connectors for supplying electricity to equipment and lights are safe and secure.

Do you propose action?

NO YES PRIORITY

Remarks

36. Use hand-held powered tools that have stable grips in easy-to-handle positions.

Do you propose action?

NO YES PRIORITY

Remarks

37. Use walk-behind machines that are easy to operate, and which stop automatically when the control is released.

Do you propose action?

NO YES PRIORITY

Remarks

38. Ensure that hoists and cranes are operated in accordance with the specified load limits and safety precautions.

Do you propose action?

NO YES PRIORITY

Remarks

39. Protect machine controls, to prevent accidental activation.

Do you propose action?

NO YES PRIORITY

Remarks

.....

40. Make emergency switches easy to locate and operate.

Do you propose action?

NO YES PRIORITY

Remarks

.....

44. Make sure there are adequate routes and slopes for moving vehicles.

Do you propose action?

NO YES PRIORITY

Remarks

.....

45. Increase the safety and comfort of driving cabins and seats.

Do you propose action?

NO YES PRIORITY

Remarks

.....

Agricultural vehicles

41. Purchase and use agricultural vehicles that are appropriately designed for agricultural work, with necessary safety precautions.

Do you propose action?

NO YES PRIORITY

Remarks

.....

46. Place loads properly on a vehicle so that they are carried safely.

Do you propose action?

NO YES PRIORITY

Remarks

.....

42. Provide a sufficient number of traffic signs, mirrors, warning signs and reflectors.

Do you propose action?

NO YES PRIORITY

Remarks

.....

47. Make sure that vehicles are not thrown sideways or overturned while at work.

Do you propose action?

NO YES PRIORITY

Remarks

.....

43. Ensure safe operation of agricultural vehicles by obtaining sufficient training, and by providing easy-to-read operation manuals.

Do you propose action?

NO YES PRIORITY

Remarks

.....

48. Arrange the different parts of vehicles so that the driver can easily see the carried objects.

Do you propose action?

NO YES PRIORITY

Remarks

.....

Physical environment

49. Increase the use of daylight in buildings by means of high windows and skylights, and by painting the walls in light colours.

Do you propose action?

NO YES PRIORITY

Remarks

.....

50. Relocate lights, or provide task lights, to ensure that there is sufficient lighting for the type of work being done.

Do you propose action?

NO YES PRIORITY

Remarks

.....

51. Improve the heat protection of buildings by backing the walls or roofs with insulating materials.

Do you propose action?

NO YES PRIORITY

Remarks

.....

52. Avoid continuous exposure to excessive heat or cold.

Do you propose action?

NO YES PRIORITY

Remarks

.....

53. Increase natural ventilation by having more openings, windows or open doorways for indoor workplaces.

Do you propose action?

NO YES PRIORITY

Remarks

.....

54. Supply sufficient airflow to silos, and other confined places where oxygen deficiencies may occur, before entering them.

Do you propose action?

NO YES PRIORITY

Remarks

.....

55. Reduce vibration and noise affecting workers in order to improve safety, health and work efficiency.

Do you propose action?

NO YES PRIORITY

Remarks

.....

56. Isolate or enclose sources of dust.

Do you propose action?

NO YES PRIORITY

Remarks

.....

57. Introduce or improve local exhaust ventilation.

Do you propose action?

NO YES PRIORITY

Remarks

.....

58. Provide sufficient fire extinguishers within easy reach, and make sure that workers know how to use them.

Do you propose action?

NO YES PRIORITY

Remarks

.....

59. Provide sufficient appropriate personal protective equipment for workers, and maintain it regularly.

Do you propose action?

NO YES PRIORITY

Remarks

.....

60. Treat animals in ways that cannot do harm to farmers.

Do you propose action?

NO YES PRIORITY

Remarks

.....

61. Be aware of animals and insects that might harm farmers unexpectedly.

Do you propose action?

NO YES PRIORITY

Remarks

.....

65. Indicate clearly each operation related to pesticides that requires the use of personal protective equipment.

Do you propose action?

NO YES PRIORITY

Remarks

.....

66. Collect safety and health information, such as the safe use of agrochemicals, and disseminate it to farmers and to the community.

Do you propose action?

NO YES PRIORITY

Remarks

.....

Control of hazardous chemicals

62. Put labels on all containers of pesticides and other hazardous chemicals.

Do you propose action?

NO YES PRIORITY

Remarks

.....

63. Keep all pesticides and other hazardous chemicals in locked containers or cabinets.

Do you propose action?

NO YES PRIORITY

Remarks

.....

64. Select safer pesticides, and use appropriate amounts of them.

Do you propose action?

NO YES PRIORITY

Remarks

.....

Environmental protection

67. Establish safe methods for dealing with used pesticide and chemical containers.

Do you propose action?

NO YES PRIORITY

Remarks

.....

68. Collect and separate waste. Recycle it so as to minimize the amount of discarded waste.

Do you propose action?

NO YES PRIORITY

Remarks

.....

69. Reduce water consumption, and protect the environment, by changing methods of water use.

Do you propose action?

NO YES PRIORITY

Remarks

.....

70. Process your agricultural products in a manner that minimizes damage and decay, and avoid the use of unnecessary packaging materials.

Do you propose action?

NO YES PRIORITY

Remarks

.....

71. Reduce the amount of pesticides used by promoting appropriate pest management techniques.

Do you propose action?

NO YES PRIORITY

Remarks

.....

72. Recycle human and animal waste by utilizing appropriate biogas technologies.

Do you propose action?

NO YES PRIORITY

Remarks

.....

Welfare facilities

73. Provide an adequate supply of safe drinking water and refreshment at all workplaces.

Do you propose action?

NO YES PRIORITY

Remarks

.....

74. Provide regularly cleaned toilets and washing facilities with soap close to the work area.

Do you propose action?

NO YES PRIORITY

Remarks

.....

75. Provide first-aid equipment, and train qualified first-aiders.

Do you propose action?

NO YES PRIORITY

Remarks

.....

76. Keep children away from machines and hazardous chemicals.

Do you propose action?

NO YES PRIORITY

Remarks

.....

77. Provide rest areas near farm fields, shaded from the sun.

Do you propose action?

NO YES PRIORITY

Remarks

.....

78. Provide recreational facilities.

Do you propose action?

NO YES PRIORITY

Remarks

.....

79. To ensure good nutrition, eat a variety of foodstuffs, such as different kinds of meat, fish and vegetables.

Do you propose action?

NO YES PRIORITY

Remarks

.....

80. Maintain a comfortable sleep environment for recovering from fatigue.

Do you propose action?

NO YES PRIORITY

Remarks

.....

Family and community cooperation

81. Organize group work activities for performing strenuous tasks with the help of experienced leaders.

Do you propose action?

NO YES PRIORITY

Remarks

82. Share the roles of agricultural and household work, and avoid overburdening any one family member.

Do you propose action?

NO YES PRIORITY

Remarks

83. Make joint investment plans to buy or hire costly machines and equipment.

Do you propose action?

NO YES PRIORITY

Remarks

84. Hold regular meetings or group activities involving neighbours, and use such occasions to review safety and health aspects.

Do you propose action?

NO YES PRIORITY

Remarks

85. Take special care of pregnant women.

Do you propose action?

NO YES PRIORITY

Remarks

86. Provide support for elderly farmers so that they can work safely.

Do you propose action?

NO YES PRIORITY

Remarks

87. Adapt facilities and equipment for farmers with disabilities so that they can do their work safely and efficiently.

Do you propose action?

NO YES PRIORITY

Remarks

88. Organize group physical exercise, and create health clubs in the community.

Do you propose action?

NO YES PRIORITY

Remarks

Work organization and working schedules

89. Combine tasks so that each worker can perform varied and interesting work.

Do you propose action?

NO YES PRIORITY

Remarks

90. Record accidents, and discuss improvement measures by analysing them.

Do you propose action?

NO YES PRIORITY

Remarks

91. Rearrange the layout and the order of operations to ensure a smooth flow of work between different worksites.

Do you propose action?

NO YES PRIORITY

Remarks

.....

92. Organize appropriate rotation of tasks or teamwork to avoid excessive machine-paced work.

Do you propose action?

NO YES PRIORITY

Remarks

.....

93. Alternate light and heavy work in order to avoid continued heavy and monotonous work.

Do you propose action?

NO YES PRIORITY

Remarks

.....

94. Provide simple and appropriate mechanical devices and tools to reduce manual work.

Do you propose action?

NO YES PRIORITY

Remarks

.....

95. Establish a means of emergency contact for farmers working alone in the fields.

Do you propose action?

NO YES PRIORITY

Remarks

.....

96. Make sure that protective measures and welfare facilities are suitable for migrant farmers.

Do you propose action?

NO YES PRIORITY

Remarks

.....

97. Plan annual work schedules, including adequate training periods.

Do you propose action?

NO YES PRIORITY

Remarks

.....

98. Establish regular working hours; avoid excessively long working days, and insert adequate weekend breaks.

Do you propose action?

NO YES PRIORITY

Remarks

.....

99. Take short breaks at regular intervals, particularly for strenuous work.

Do you propose action?

NO YES PRIORITY

Remarks

.....

100. Ensure regular timing of meals, especially during harvesting and other busy periods.

Do you propose action?

NO YES PRIORITY

Remarks

.....

Storage and handling of materials

Farmers have to store and handle many kinds of materials. These are heavy, and vary in size and shape. In this chapter you will find simple, practical solutions for improving methods for storing and handling materials. They include clear routes for carrying materials, the use of multi-level shelves to keep materials in good order, and the application of simple devices such as push-carts or roller-conveyors. These ideas will all help to improve not only productivity and efficiency, but also safety and health.



CHECKPOINT 1

Keep transport routes clear and in good condition for the movement of people and materials.

WHY

Transporting agricultural products and materials is an important part of farming work. Many agricultural products and materials are heavy; they vary in shape, and can be difficult to handle manually. Narrow, rough or slippery transport routes make it difficult to transport materials. Good transport routes ensure the safety of transport and prevent agricultural products from loss or damage.

Good transport routes not only ensure safe and quick transport, but also prevent accidents and injuries to the farmers.

HOW

1. Make transport routes wider, and keep them well maintained. Two-way movement of people, farm products and materials should be possible on the main transport routes to farm fields, and to agricultural work facilities.
2. Improve and clean up the transport routes to fields and facilities, and those around your house. To avoid their becoming muddy during the rainy season, build them on higher, more stable ground, and cover them with thin layers of small pieces of brick, crushed stones or cement.
3. Make sure there are no obstacles on paths and transport routes, and establish the practice of placing nothing on them. Provide proper places for storage, and for waste disposal.
4. If canals or ditches are used as water routes to the farming fields, dredge them regularly, so that boats transporting agricultural products can pass along them smoothly.

WAYS TO PROMOTE COOPERATION

Start with a simple, low-cost way of improving main transport routes. For example, clean the paths in front of your house, or the transport routes leading to farming fields. People will notice that transportation has become faster and safer.

Develop the habit of cooperating with farm workers, family members or neighbours. For example, regularly work together to maintain and improve the transport routes, or to dredge the canals.

SOME MORE HINTS

- Make sure the boundaries of transport routes are easy to see, for example by marking them with small stones or with cement, or by fencing them.
- Gradually improve transport routes by using locally available materials, such as gravel or crushed bricks.

POINTS TO REMEMBER

Clear, wide and solid transport routes make it easier to transport agricultural products, and help to prevent injuries and damage.



Figure 1a. Maintain clear, wide transport routes for safe movement of people and farm products.



Figure 1b. Transport routes leading to gardens and rice fields are earthed up evenly, and are wide enough that carts and trucks carrying agro-products can reach the workplace. This avoids heavy manual handling.



Figure 1c. A clear, wide entrance, marked by a hedge of hibiscus.

CHECKPOINT 2

Eliminate sudden height differences and holes on transport routes, and use ramps or slopes where necessary.

WHY

Carrying loads on rough roads, or over a floor with many obstacles, hampers the flow of work. Keeping the surface of transport routes free of obstacles will help work flow more smoothly.

Sudden height differences and holes on the surface can cause stumbling or accidents, and can damage valuable agricultural tools and vehicles. Eliminating these height differences saves time and energy, and prevents unnecessary accidents.

HOW

1. Remove all sudden height differences and obstacles in the transport routes to farm facilities and fields. Fill in all holes that might cause stumbling or accidents.
2. If there is a height difference between two parts of a route, or between the route and the field, form a ramp by sloping the route, or by using a platform. Such ramps help smooth the movement of wheeled equipment and vehicles.
3. Inspect filled-in holes and planks used to eliminate sudden height differences frequently, and fix or repair them if necessary. At the same time, take the opportunity to widen the main paths or ramps, to allow two-way transport.

WAYS TO PROMOTE COOPERATION

Maintenance of good transport routes without obstacles is the task of everybody in the family, and in the community. Groups of farmers can take the voluntary initiative for regular maintenance of these routes. This cooperation can be gradually widened to the whole community.

Make it a routine community activity to maintain paths and remove dangerous height differences.

SOME MORE HINTS

- If dangerous height differences cannot easily be eliminated, place prominent, simply worded warning signs.
- Cover the surface of ramps or slopes used for transportation purposes properly by using non-slip flooring panels, anti-slip plywood, non-slip square or round-nosed treads, or even anti-slip tape, to reduce the risk of slipping.

POINTS TO REMEMBER

Maintaining routes without dangerous height differences provides a simple, but important, contribution to safe transportation. This requires the cooperation of everyone concerned.



Figure 2a. Provide ramps with a small incline over the sudden height difference at the entrance to a building.



Figure 2b. Ramps can be useful for pushing a cart into a greenhouse.

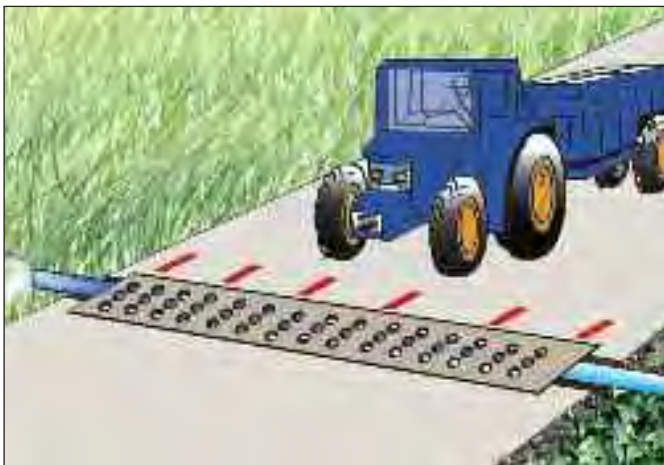

Figure 2c. Eliminate sudden height differences on the road, to allow smooth transport.



Figure 2d. Build a small slope with a shallow incline for easier access to farm fields.



Figure 2e. Use a ramp to load a vehicle onto a boat safely.



Figure 2f. Use ramps to load an agricultural vehicle onto a truck.

CHECKPOINT 3

Construct sufficiently wide, stable bridges over rivers, canals and ditches.

WHY

Safe bridges over canals or ditches are essential for the safe travel of people and efficient transportation of farm products.

Even a small ditch at the edge of a field or road needs an appropriate bridge. Jumping across the ditch, or using inappropriate materials as a makeshift bridge, such as the trunk of a dead tree, can cause accidents and damage products. Sharp-edged materials used for makeshift bridges can also cause severe injuries.

Narrow, rough or slippery transport routes or floors hamper the easy transportation of materials.

Agricultural products may be lost, valuable tools may be damaged, and there is a higher risk of causing accidents.

HOW

1. Check the paths and transport routes leading to farm facilities and to farm fields. Make sure that not only canals and rivers but also ditches at the edges of fields and roads are properly bridged. Bridges should be stable, and wide enough for the safe transport of farm products and machines.
2. Build safer, stronger bridges. Try to make them wider. Add firm handholds for larger bridges over canals or rivers. Check the condition of bridges regularly, and strengthen the bridge frames if necessary.
3. Eliminate height differences along the routes leading to bridges. Make the surfaces of the routes even and obstacle-free. Use planks or other sturdy materials to cover the surfaces.

WAYS TO PROMOTE COOPERATION

Form a team of farmers from the same community, and encourage them to work together in checking bridges over canals and rivers. In consultation with local people, the team can jointly plan and construct new bridges as needed, or improve existing ones. Cooperate with community leaders and local authorities. For small

ditches, try to follow examples of good practice that you find in the community. Repair rotten or damaged parts of bridges in a joint effort with your neighbours.

SOME MORE HINTS

- If temporary small bridges are being used, make sure that they are built with proper materials and are not slippery, and that they are wide and sturdy enough to allow the passage of wheeled equipment.
- The space under each bridge over a canal or river should be large enough for boats to pass safely. For bridges over ditches, the space under them should be properly maintained so as not to disturb water flow.

POINTS TO REMEMBER

Bridges that are stable and wide enough can provide farmers with a safe transportation means, and help to enhance communication among people.



Figure 3a. A wooden bridge, with firm handholds, constructed over a river. The bridge deck is wide enough for the transport of people and farm products.

Figure 3b. Where there is a small stream or a narrow ditch, a firm bridge can facilitate the transportation of farm products.



Figure 3c. Build a safer and stronger bridge across a wide river for safe transport.



CHECKPOINT 4

Use carts, hand-trucks and other wheeled devices when carrying materials, tools and products.

WHY

Farmers need to carry agricultural products and tools between their farms and storage areas every day. By using carts, hand-trucks, vehicles or boats you can greatly reduce your workload and fatigue.

You can minimize damage to farm products by carrying them on carts and vehicles, and also reduce accident risks.

The use of carts, hand-trucks or other vehicles can significantly reduce the number of trips. This is very advantageous for improving efficiency and safety.

HOW

1. Use carts or hand-trucks with firm handles for carrying heavy materials or large quantities of materials. To use them effectively, you may need to improve paths and bridges.
2. To carry materials over longer distances, use larger carts or vehicles. Make sure that they are suitably adapted for carrying the particular products or materials.
3. Take advantage of canals and rivers to transport materials. Motorized boats will make your work much easier, especially when you are carrying extremely heavy loads or a large quantity of materials.
4. Use cows, horses, buffaloes or goats to pull carts for carrying materials and products.

WAYS TO PROMOTE COOPERATION

Walk around your village with fresh eyes. Discuss with your neighbours how they carry loads. There may be excellent examples of using self-made carts or hand-trucks. Exchange ideas and experiences to reduce your workload, and to improve your safety.

SOME MORE HINTS

- Attach appropriate side-boards to carts or hand-trucks to contain products or materials while they are being carried and prevent them from falling off.
- Use different types of cart or hand-truck for different kinds of transport work. Learn from good examples.
- Check the condition of carts, hand-trucks, vehicles and boats regularly, and always keep them in good condition. Simple maintenance activities will reduce fatigue and help prevent accidents while carrying loads.
- Well-maintained transport routes will maximize the effectiveness of using carts, vehicles or animals for carrying materials.

POINTS TO REMEMBER

There are many kinds of device that are useful for carrying heavy materials in specific conditions. You can learn from local experiences.

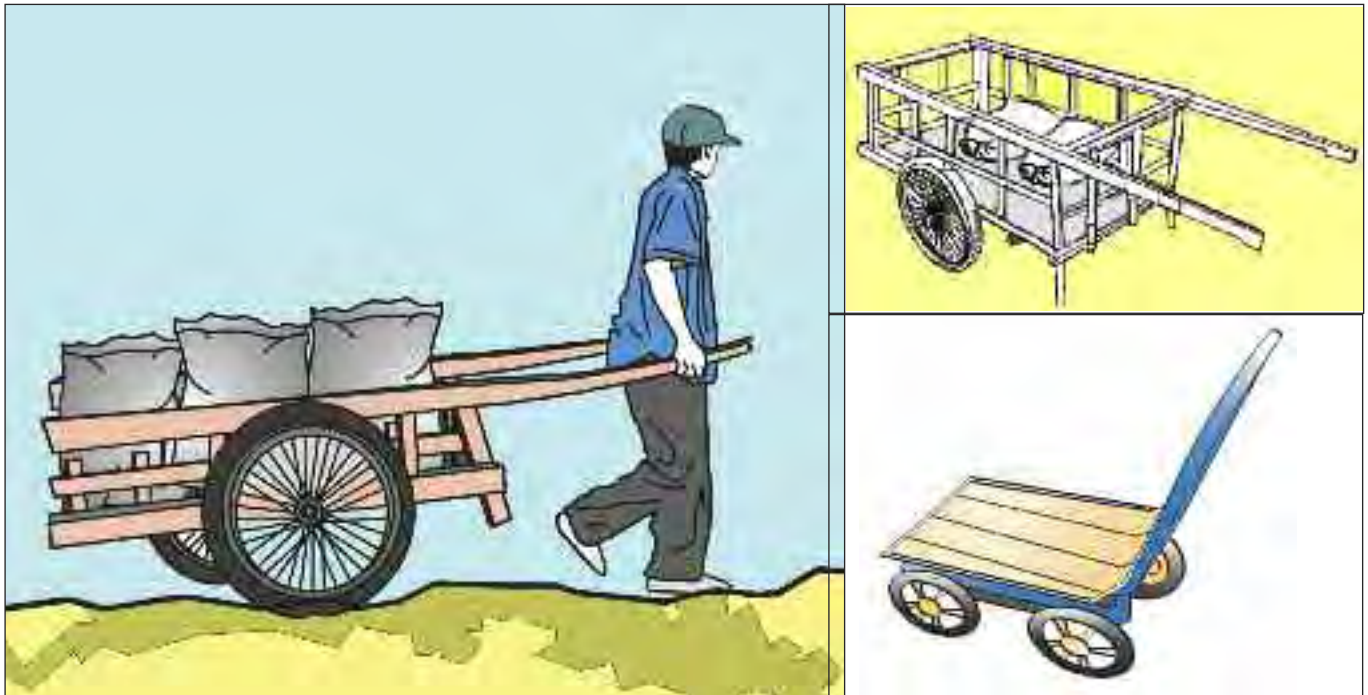

Figure 4a. Use carts and hand-trucks to carry heavy objects and farm products.



Figure 4b. Modify your bicycle so that it can be used as a means of transport.



Figure 4c. A cart modified to carry a variety of farm products.



Figure 4d. Ensure safe use of barrows.

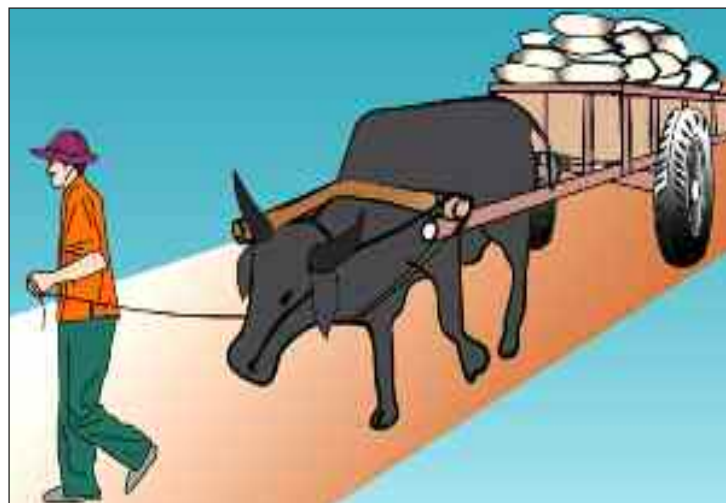

Figure 4e. A cattle-drawn cart for carrying farm products.

CHECKPOINT 5

Make sure the wheels on carts and hand-trucks are large enough to work effectively on field routes.

WHY

Farm products and other materials need to be transported from one place to another. Longer transportation times on bumpy routes can increase damage to products. Carts and hand-trucks with larger wheels can work even on bumpy and muddy field routes, and make transportation easy and safe.

Large wheels make transport work easier, and reduce farmers' fatigue. They also contribute to the prevention of accidents, particularly on rutted or uneven field routes.

HOW

1. Check the wheels on your carts and hand-trucks. Are they large enough for the products to be transported, in view of the transport routes and surface conditions? If not, attach larger wheels. Check the stability of the attached wheels; larger wheels need stronger fixing and frames.
2. Choose rubber-tyred wheels if they are available. Often, used bicycle or motorcycle wheels will meet your requirements. Check the pressure of the tyres to prevent under- or over-inflation. Correct inflation will not only help prevent damage to your tyres, but also help you to ride smoothly, even on bumpy routes.
3. If you cannot change the size of the wheels, attach push or pull handles to carts and hand-trucks so that you can move them easily at waist level.
4. Design different-sized carts or hand-trucks specifically for different products, so that they are protected from damage, and are easy to load and unload.

WAYS TO PROMOTE COOPERATION

Exchange ideas about how to make wheels of appropriate size. Learn from existing examples. Find and use available materials, such as bicycle wheels or used planks. For better designs consult with each other,

based on your and your neighbours' experiences. Neighbourhood cooperation will be greatly enhanced when you have jointly designed carts or hand-trucks minimizing physical efforts and protecting farm products against spoilage.

SOME MORE HINTS

- The height of carts and hand-trucks may increase when larger wheels have been attached. Appropriate platforms may help farmers to load and unload materials when using carts with larger wheels.

POINTS TO REMEMBER

Carts and hand-trucks with larger, well-designed wheels greatly help farmers to carry materials, even on bumpy, muddy or uneven field routes.



Figure 5a. On rough roads, it is easier to push or pull hand-trucks with large wheels (left) than those with small wheels (right).

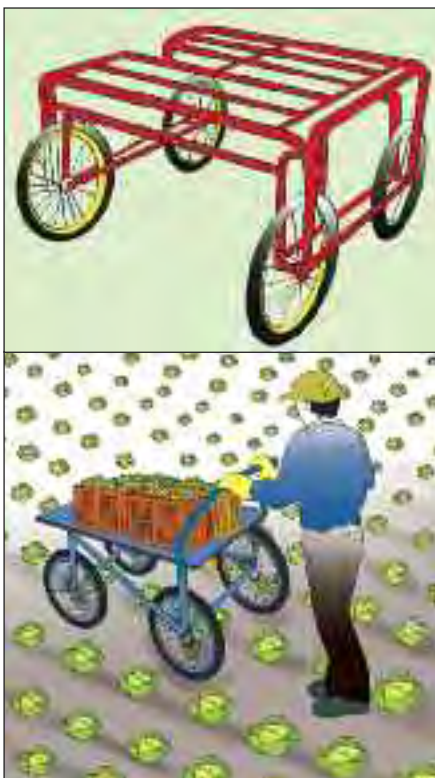

Figure 5b. Use wheels with wider, well-inflated rubber tyres to make it easier when pushing a cart in the field.



Figure 5c. A comfortable strawberry-picking vehicle with a wheeled work-seat.

CHECKPOINT 6

Provide multi-level shelves or racks near the work area for storing materials, tools or products.

WHY

Multi-level shelves and racks allow a better use of space, and help you keep farm products or agricultural tools in good order. By placing things on multi-level shelves, you can easily find necessary items at an appropriate height, which can save time.

Agricultural hand tools are essential for farmers. By keeping tools in specific places, you can save your valuable time and energy in picking them up.

Multi-level shelves and racks also reduce the danger of accidents and fires, as things kept there are more easily and more safely maintained.

HOW

1. Site multi-level shelves and racks at places that are easy to access. Fitting them to the wall will help you make full use of wall space.
2. Put labels, or draw shapes of the various items or tools, on the front of shelves or containers to show where each one is kept. This saves time in searching.
3. Ensure that multi-level shelves used to store heavy farm products or other heavy items are strong enough. It is best to fix such shelves to the wall.
4. Multi-level racks are also useful in the kitchen. You can keep pots, pans, knives, spoons and other utensils, as well as cooking materials and ingredients, neatly on the racks. Containers for ingredients, such as salt, sugar, peppers and spices, should be corked and labelled.

WAYS TO PROMOTE COOPERATION

Start with a small change. For example, a shelf for small utensils or ingredients is easy to make. All family members can see the resulting improvement. This will stimulate other family members, and members of the community, to apply similar ideas. Try to spread the habit of labelling important items. Encourage people to exchange good examples.

SOME MORE HINTS

- Place frequently used items at a level between your waist and your shoulder. Keep heavy and less frequently used items at a lower level. Light and infrequently used items can be stored in the overhead space.
- Use small trays or pallets for storing similar items. This makes it easy to find the necessary items.
- Make some of the racks movable, or use trolleys. These can be used to store items that are used in more than one place (for example, in both the storeroom and the work room).

POINTS TO REMEMBER

Proper use of multi-level shelves and racks can both save you time and save space.



Figure 6a. Well-designed multi-level racks for farm products. They look tidy, and save a lot of space in your house or work room.



Figure 6b. Agricultural hand tools and personal protective equipment are placed tidily and in order on hangers and multi-level racks.



Figure 6c. Multi-compartment cabinets contain spices and food, and the racks and hanging storage for cooking utensils can facilitate meal preparation.

CHECKPOINT 7

Instead of carrying heavy weights, divide them into smaller, lightweight sacks and packages.

WHY

Farmers often have to carry various heavy items during their work. This is strenuous, and can often be dangerous. If these heavy items are divided into smaller loads, the carrying work is both easier and safer.

Fatigue from carrying packages is reduced for lightweight packages than for heavy weights. Farmers can thus save energy and do more productive work by using smaller packages.

By using light packages instead of heavy packages, the risk of low-back injuries is also greatly reduced.

HOW

1. Divide heavy loads into lighter packages, containers or trays, considering the maximum weight that is easy for farmers to carry. For example, two packages of 10 kg each are much better than one package of 20 kg.
2. Dividing loads into smaller amounts may mean increased movements and more trips for carrying the same total amount. Therefore make sure that loads are not too small. Use effective means of moving or carrying these smaller loads, such as rollers or carts.
3. The use of push-carts, trolleys or mobile racks can help save time. For manual transport, a cart can usually transport more loads with less effort. Manual loading and unloading is much easier for smaller and lighter loads.

WAYS TO PROMOTE COOPERATION

Try to get everyone to use the same types and sizes of container, basket or tray for carrying materials or farm products. As people get accustomed to using these, it will make the use of carts and hand-trucks easier. Encourage people to exchange good examples.

SOME MORE HINTS

- Make available an adequate number of reusable containers, trays and baskets; these facilitate the transport of loads, and help save money.
- When loads are divided or smaller containers are used, try to use labels so as to make it easy to distinguish the different loads or containers.

POINTS TO REMEMBER

A lighter weight is a safer weight. Divide heavy packages into lighter ones to ensure safety and increase productivity.



Figure 7a. Put farm products in smaller bags with firm handles. Sharing the weight with both arms makes your work more comfortable.



Figure 7b. Using a pannier with firm handgrips, two persons can carry heavier loads.

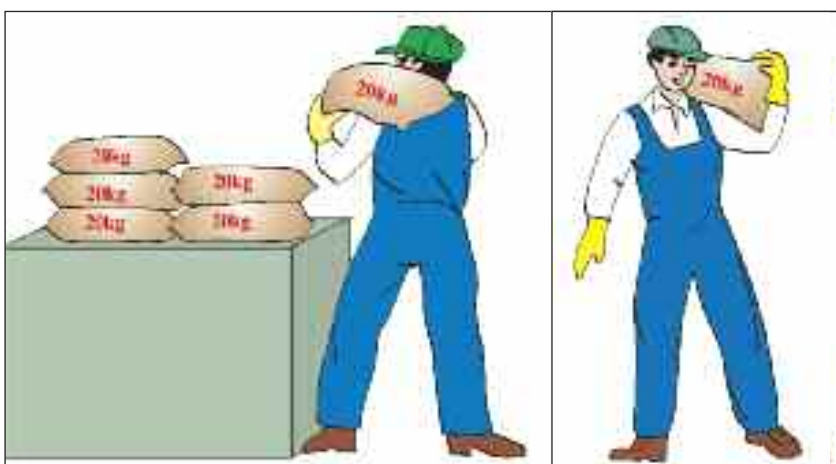

Figure 7c. It is always better to use smaller packages. Loading and unloading may require more trips, but fatigue will be reduced.

CHECKPOINT 8

Provide specially designed containers, pallets or trays of appropriate size for storing and moving materials and farm products.

WHY

Materials and products handled in agriculture have a wide variety of sizes and shapes. Specially designed containers, pallets or trays are useful for storing and moving these items.

Special containers for a particular kind of farm product simplify handling and making inventories.

Containers of the same size and with firm grips are suited for carrying in carts or hand-trucks.

HOW

1. Learn from existing experience of using containers and baskets appropriate to the products to be transported. Discuss what shapes, materials or sizes are useful for carrying particular kinds of farm product or material.
2. Provide reusable containers or trays suitable to avoid waste.
3. Depending on the types of materials carried, you can design containers, pallets or trays that carry a specific amount, so that it is easier to make an inventory of the total amount.
4. Where possible, use the same containers, pallets or trays for both carrying and storing items. This simplifies handling, and saves time.

WAYS TO PROMOTE COOPERATION

Learn from good examples already put into practice by other people. There are many different types of container and pallet. Try to use the same shapes and sizes of container so that people can cooperate better in transporting materials and farm products.

SOME MORE HINTS

- Use carts, hand-trucks, trolleys or mobile racks of appropriate dimensions to move or carry the particular materials or farm products. Use of these with the special containers will make the work much easier and more efficient.
- Make sure that the containers, pallets or trays designed for a particular purpose have good grips or holding points.
- Specially designed multi-level shelves or racks are useful for efficient storage of the containers, pallets or trays used. Often such shelves or racks are designed to be mobile.

POINTS TO REMEMBER

Specially designed containers, pallets or trays of various sizes make it easy to move or carry materials or farm products.



Figure 8a. Choose containers appropriate to the farm product. Using the proper container not only protects your product from damage, but also makes your work more comfortable.

Figure 8b. Choose containers or baskets that have proper grips or handles.



Figure 8c. Pallets of different sizes are used to store and carry many packages.



Figure 8d. Multi-level shelves are useful for storing different containers and trays together.

CHECKPOINT 9

Provide good grips or holding points for all containers and packages.

WHY

Good handgrips or appropriately located holding points have multiple benefits. They help you handle the materials easily and safely. A simple handgrip attached to your load also ensures a clearer forward view.

Handgrips help prevent loads from being dropped and materials from being damaged. A good handgrip can improve your work posture and help prevent fatigue.

Carrying loads frequently or to a distant place is often very strenuous. Good grips can reduce the resulting fatigue and so make the work safer.

HOW

1. Choose containers or baskets of relatively small size and with proper grips or handles. Lighter loads are easier to handle, and make the use of grips or holding points more effective.
2. If grips or holding points are not present, attach them yourself. Experiment to find the best locations for them.
3. Wherever possible, divide loads into smaller, lighter ones. This means that grips can be utilized more effectively.
4. Make sure that the grips or holding points are also appropriate for loading and unloading of the containers or packages.
5. Try to modify existing grips or holding points, based on the experience of other farmers. It is often possible to improve existing grips or handles by making them more stable or easier to grasp.

WAYS TO PROMOTE COOPERATION

Explain to everybody that grips or handles can be added at low cost. You may find existing good examples of the use of appropriate grips in your neighbourhood. Encourage people to exchange such good ideas.

SOME MORE HINTS

- Choose small containers that can be easily and safely piled up. This will make loading and unloading of these containers much easier and faster.
- Wearing gloves, or wrapping grips or handles with soft cloth, may make it easier to carry loads.
- Keep your wrists in a comfortable and straight position while holding grips. If necessary, enlarge the holes adjacent to the grips.

POINTS TO REMEMBER

Easy-to-grasp grips or holding points make the handling of containers or packages much easier and safer.



Figure 9b. Provide good handles for all baskets.

Figure 9a. Provide good grips for all containers used.



Figure 9c. Add handles to tool boxes.



Figure 9d. A battery contains dangerous chemicals. Put it in a container with safe, firm handles.

CHECKPOINT 10

Use mobile storage racks or wheeled stands for storing and moving materials, tools and products.

WHY

Often a large number of items need to be carried from one work area to the next. If these items are put on mobile racks, many unnecessary trips can be avoided.

Carrying work items on mobile racks reduces not only the number of trips, but also the number of materials-handling operations.

Fewer trips, with less materials handling, help reduce damage to work items.

HOW

1. Use racks that have wheels and can be used to move several items at the same time. Purchase or design mobile racks that are easy to load and unload.
2. Fix wheels on the table or stands used for handling materials or farm products. These can then be used to move the items from one work area to another, thus avoiding unnecessary loading and unloading.
3. Arrange the layout of the work area so that wheeled racks or stands can be easily moved. If necessary, clear obstacles from the passageways.
4. Choose containers, packages, bags and baskets that can be placed on a mobile rack.

WAYS TO PROMOTE COOPERATION

When many similar racks are used, for example for handling a large quantity of farm products, standardize the racks. Similarly, when many containers are used for moving materials or farm products, standardize them so that they can be placed easily on a mobile rack.

SOME MORE HINTS

- It is useful to make mobile racks specially adapted to the materials or products carried. This may seem to require a lot of effort, but it is worthwhile, because such racks are extremely helpful in improving productivity.

- Maintenance of wheels is very important. Well-maintained wheels make pushing and pulling easier.
- Simple trays that can contain several items are often very useful.

POINTS TO REMEMBER

Mobile racks are an important answer to reducing materials-handling and transport time. You can gain much from mobile racks.



Figure 10a. Mobile racks can reduce the number of trips.



Figure 10b. Attach wheels to your containers.



Figure 10c. Place containers on a mobile multi-level rack.



Figure 10d. Make your containers mobile.



Figure 10e. Carry your machines on a special wheeled device.



Figure 10f. A specially designed hand-truck for carrying waste containers.

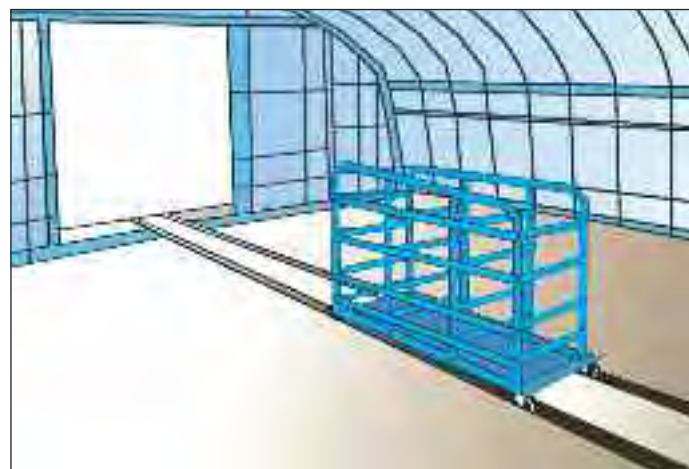

Figure 10g. Multi-level shelves can also be mobile along a route.

CHECKPOINT 11

Use hoists, rollers, conveyers or other mechanical means for moving or lifting heavy materials.

WHY

Many farmers used hand-made rollers or wheeled platforms, often made of locally available materials. These simple devices can help them move heavy materials such as agricultural products, machines and packages. Rollers placed in the form of a conveyor are particularly useful where heavy materials are moved regularly.

Rollers that bridge height differences can allow farmers to move heavy materials without manual lifting or lowering. They can thus avoid awkward and strenuous bending postures that might cause low-back pain.

Similar ideas can be applied to various farming activities. For example, wooden rollers put under a heavy agricultural machine or boat make moving it much easier.

HOW

1. Try to use roller-conveyors when heavy materials are moved over a short distance. Put both ends of the rollers in stable positions at an appropriate height for loading and unloading the materials.
2. Learn from existing ways of using rollers or wheeled devices for moving materials. Design appropriate roller-conveyors or wheeled platforms for your moving work. Select durable materials that can support heavy weights safely.
3. When moving heavy objects on the ground or on passageways, wooden rollers put under them may help your work greatly. Examples include carrying an agricultural machine to the rice field, moving boats to the river bank, and moving a heavy cabinet.
4. Use inclined roller-conveyors for moving heavy materials between two places with a height difference, for example when moving rice bags or heavy packages from storage areas to nearby platforms, or when moving farm products to or from vehicles or boats.

WAYS TO PROMOTE COOPERATION

Roller-conveyors can save people's energy, and provide them with opportunities to work together. Exchange ideas about how to apply roller-conveyors for various types of work, and design an appropriate one jointly.

SOME MORE HINTS

- Rollers and conveyors need good maintenance. Check all parts, such as rollers, steel beds and rubber beds, at regular intervals. This is important to prevent accidents. If your rollers or conveyors are portable, keep them in a safe place, away from children.

POINTS TO REMEMBER

Rollers and conveyors provide an effective means of moving heavy objects over a short distance.



Figure 11a. A manually powered device to move pallets with heavy items.



Figure 11b. An electric chain hoist with a control switch, used for efficient lifting of heavy loads.



Figure 11c. A forklift that can move or raise heavy loads efficiently.



Figure 11d. A manually powered device for lifting heavy items to working level.



Figure 11e. Use roller-conveyers to move heavy objects over short distances.

CHECKPOINT 12

Keep objects close to the body when carrying them.

WHY

It is often better to reduce the amount of load carried at a time, but this is not always possible. In this case, carrying each load close to the body can reduce fatigue and prevent the risk of back injuries.

Holding objects close to the body makes carrying easier, and helps provide a better forward view. This increases efficiency and reduces accidents.

Carrying the load close to the body makes better use of your arms and legs; your leg muscles can be more effectively used.

HOW

1. When lifting or lowering a heavy load, do this slowly in front of you, keeping the load close to your body.
2. When lifting a heavy load, use the muscle power of your legs, not of your back, and keep your back straight. This is more easily done when carrying the load in front of and close to your body.
3. Provide handles, grips or good holding points for the load being carried. Again, approach the load as closely as possible, and hold it firmly and near your body.
4. If a load is heavy, before you lift it, always consider first whether it can be divided into smaller, lighter loads.

WAYS TO PROMOTE COOPERATION

Discuss whether it is useful to make the loads carried smaller. The use of easy-to-handle containers or packages can help in carrying these loads.

If it is not possible to divide a heavy load into smaller ones, ask two or more people to help carry the load. Also consider the use of transport vehicles, by sharing such vehicles with neighbouring farmers.

SOME MORE HINTS

- Organize the carrying work so that it is done with minimal raising or lowering of the carried load. Often this is done by using stands or platforms of appropriate height.
- While carrying, keep the load near your waist. This helps you hold it in a stable manner.
- The farmer may prefer to carry a load on the shoulder, the head or the back, depending on its size and weight, as well as on local custom. Try to find alternative ways to carry the load more easily. Often easy-to-carry containers or sacks can help.

POINTS TO REMEMBER

When manual carrying of loads is unavoidable, lift and carry the load close to the body. This reduces fatigue and the risk of injury.

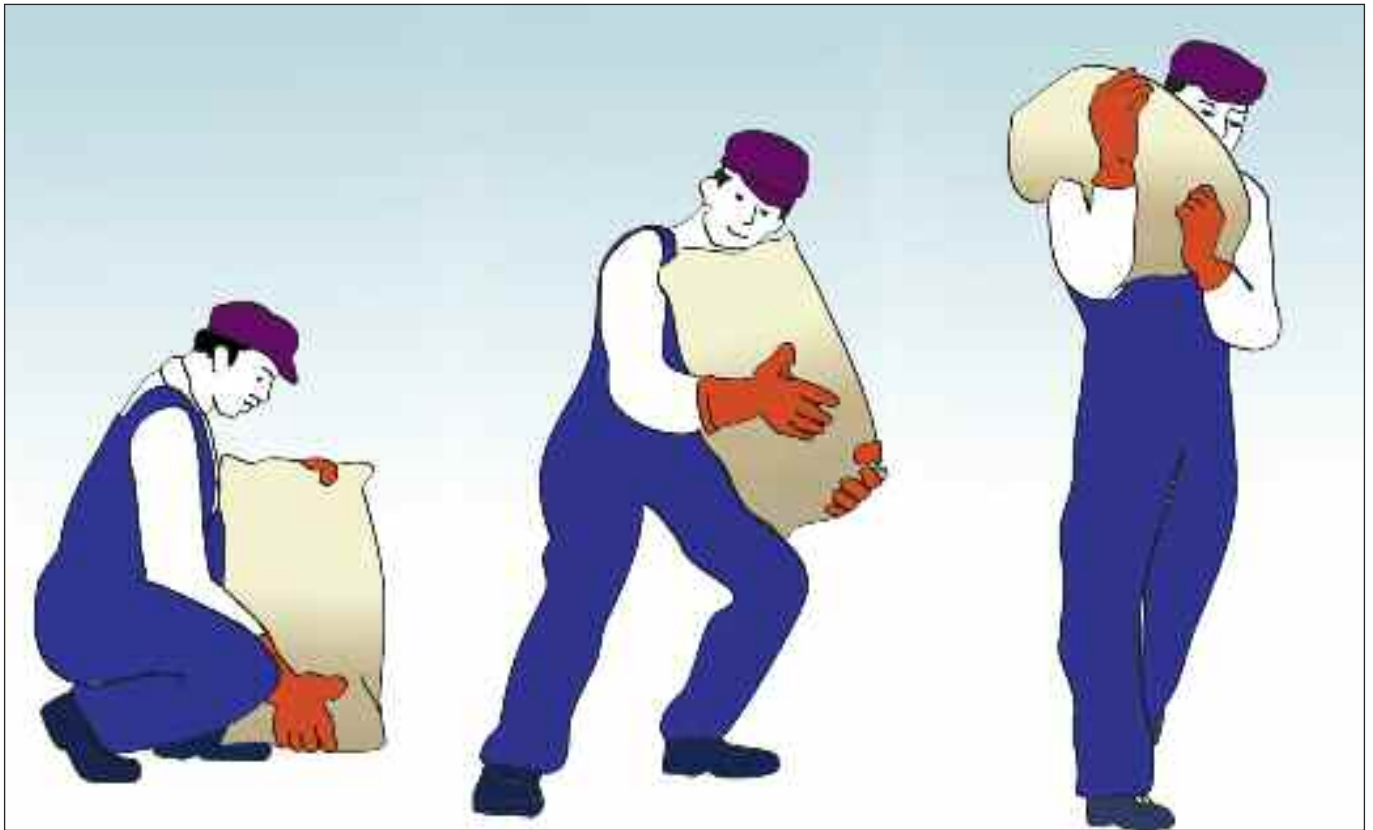

Figure 12a. Keep the load close to the body. It is important to be as near to the load as possible when you start to carry it.



Figure 12b. Cut-out handholds are very useful. Locate these handholds so that the box or container can be carried in front of the body.

CHECKPOINT 13

Eliminate or minimize height differences when moving materials manually.

WHY

Manual transport of materials and farm products takes time and energy, and often results in damage. Accidents can occur when loads are dropped, or when the farmer carrying them falls or stumbles. These problems can be much reduced by minimizing lifting and lowering movements.

By avoiding lifting and lowering of loads, you can reduce fatigue and minimize product damage.

Lifting heavy loads is one of the most strenuous types of work, and a major cause of back injury. By avoiding lifting movements, you can also reduce the risk of injury.

HOW

1. When moving materials or farm products from one work area to another, move them at the same working height, for example move them between work surfaces at the same level.
2. Place materials or farm products on work-stands or platforms to reduce height differences when moving them.
3. Use transport vehicles or mobile racks with which you can move materials or products without changing the height. For example, use rollers or trolleys that are of the same height as the work tables.
4. Match the height of the vehicle bed to that of the loading area, so that loading and unloading can be done with minimum height differences.

WAYS TO PROMOTE COOPERATION

Try to organize the transport of heavy materials or products jointly. Seek ways to move or carry them at the same level as much as possible. This is also useful when loading to or unloading from vehicles, or when packing products.

Purchase mechanical lifting devices for which the height for moving materials can be adjusted. Examples include lift trucks, rollers and conveyors.

SOME MORE HINTS

- When moving materials or farm products between different platforms or work tables, place these platforms or tables close to each other; it is then easier to move the objects at the same height.
- Lift trucks, rollers and conveyors need good maintenance. Check all parts at regular intervals.
- If large items are placed at ground level, use a yoke, sack or low-level pallet trolley to carry them with minimum elevation.

POINTS TO REMEMBER

Move materials or farm products at working height. Use mechanical devices to raise or lower them to the working height.

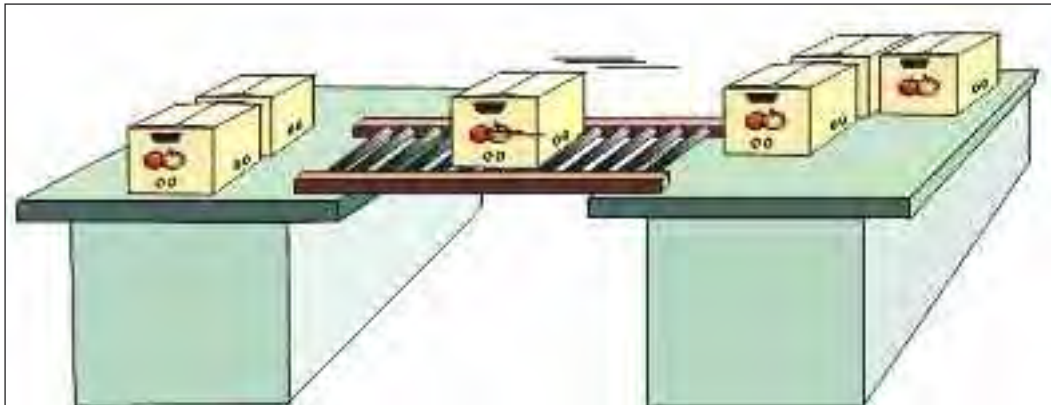

Figure 13a. Eliminate height differences between work surfaces, and place these work surfaces close to each other.



Figure 13b. Minimize height differences between the lift truck surface and the work table.



Figure 13c. Eliminate or minimize height differences between the work surfaces of different people. This minimizes lifting and lowering of items.

CHECKPOINT 14

Develop convenient containers or other means for collecting waste at the workplace.

WHY

Wastes not only represent a loss of materials and a hindrance to the smooth flow of work, but also are a major cause of accidents. These can be avoided by providing waste containers.

Good housekeeping is difficult without waste containers provided in convenient places.

Waste containers that are conveniently placed and easy to empty help create free space and reduce cleaning work.

HOW

1. Use local materials or reuse boxes to construct waste containers suitable for different kinds of waste.
2. Locate a sufficient number of waste containers near the work area.
3. Select appropriate waste containers according to the types of materials or farm products: for example, boxes for solid waste, closed containers for liquids, and platforms for long items.
4. Learn from the good practice of your neighbouring farmers in collecting waste at the workplace.

WAYS TO PROMOTE COOPERATION

Proper waste containers are very important for any farm. Discuss where to place waste containers, and provide containers of different sizes to suit the types of waste produced.

Find appropriate ways of recycling as much waste as possible. Learn from your fellow farmers, or from good examples.

Consult your neighbouring farmers about the best way to empty waste containers at appropriate intervals. Rotate the emptying task between people from the same district.

SOME MORE HINTS

- Place simple plastic containers at each work area so that each group of working people can find places for wastes.
- Provide separate containers for wastes of different kinds or from different sources. This helps in recycling them.
- Put wheels under waste containers to help in clearing them.

POINTS TO REMEMBER

Good housekeeping requires waste containers to be located at appropriate places. Wastes thus stored can be recycled.



Figure 14a. Provide waste containers that are conveniently placed and easy to empty.

Figure 14b. Locate waste containers near the work area, and make it easy for farmers to put the wastes from their work into the containers.



Workstations and tools

Farmers and their families work both on the farm and in their houses. They have to sort and pack agricultural products, and also do cooking and other family jobs at home. Farmers need appropriate workstations and tools for these jobs. Well-designed workstations prevent pain in the back, neck, arms and legs, resulting in increased work efficiency. This chapter provides practical measures to help you design the best workstations and work tools for you. The ideas include appropriate working height, stable chairs and working tables, measures to avoid strenuous work postures, and tools helpful for reducing the force you need to apply. These improvements are all possible at low cost.



CHECKPOINT 15

Put frequently used tools, switches and materials within easy reach.

WHY

Putting frequently used tools and materials within easy reach minimizes unnecessary movements. This also avoids strenuous work postures, such as stretching or bending forward, and saves time and energy.

The “easy reach principle” can be applied to all sorts of tools and materials. Agricultural tools such as knives, hoes and sickles should be placed within easy reach. At home, the same principle is useful for things such as utensils, spice jars and bottles used for cooking. Power switches and controls, too, should be placed in a convenient place. All these arrangements will help you complete your work with minimum effort.

HOW

1. First, select the most frequently used materials and tools that should be located within easy reach. When making your selection, consider the needs both on your farm and within your home.
2. Place these tools and materials in an area within your reach. Move other tools and materials to appropriate storage places.
3. If necessary, use shelves, racks or hangers to keep needed tools and materials within easy reach.
4. Place work items or hand tools that you often use in the field, such as fasteners, scissors, knives, hammers or containers for drinking water, within easy reach. Design a special belt or bag to carry them with you while you are working.
5. Position the displays and control panels of pumps, threshing machines and other agricultural machines where they are easy to see.

WAYS TO PROMOTE COOPERATION

Place frequently used materials and tools within easy reach. Collect good examples from your village. Consider the special needs for materials in the home, such as spice jars, pan hangers, tool hangers and shoe racks, and farm tools such as knives and hoes when positioning them. Share local wisdom with your neighbours. Help each other develop innovative solutions by using local resources.

SOME MORE HINTS

- Shelves and materials containers will help you keep frequently used materials within easy reach and in an orderly manner.

POINTS TO REMEMBER

Time and energy are saved by placing tools, switches and materials within easy reach.



Figure 15a. Provide tool storage cabinets near the work area, within easy reach.



Figure 15b. Place panniers for raw products and materials within easy reach.



Figure 15c. Fix pan hangers within housewives' reach. Place frequently used items within easy reach; others higher.

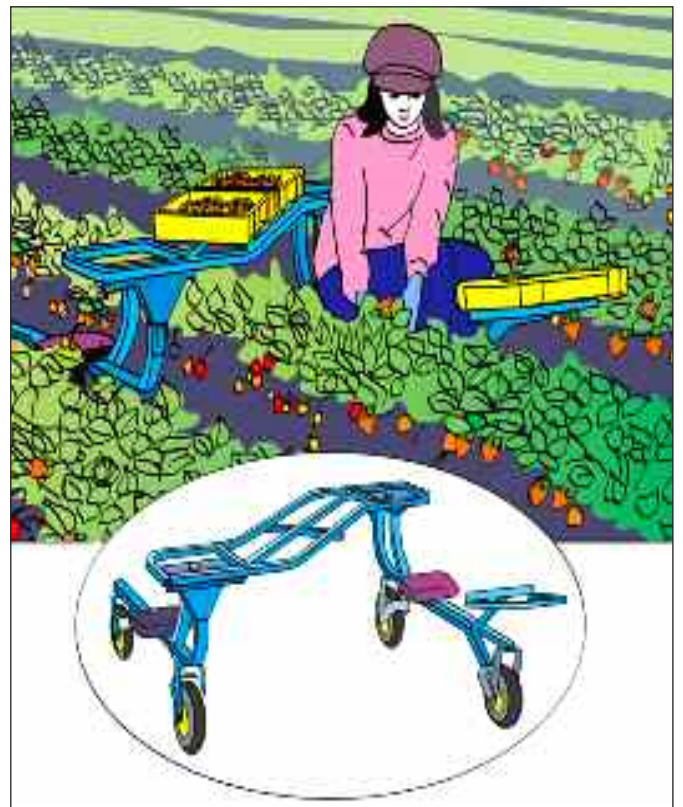

Figure 15d. A well-designed mobile workstation, in which baskets of agricultural products are placed within easy reach.

CHECKPOINT 16

Provide a “home” for each tool.

WHY

You may have seen cluttered work areas, where tools and devices were scattered around on the floor. How did you feel when looking at them? They were not safe, and not efficient. Valuable, often expensive, tools and devices can be easily damaged. Much time and effort can be wasted in searching for lost tools. The results are often disappointing. Your stress and strain will be raised, too.

Providing a “home” for each tool is a simple and effective solution to increase both safety and efficiency, and allows you to see at a glance which tools are still missing. Each of your tools should be returned to its designated position after use. At the end of your work, you will quickly know whether all tools are back “at home”.

HOW

1. Many farmers have developed simple “homes” for agricultural or cooking tools using pieces of bamboo or wood. They can hang knives, sickles, billhooks and other tools in good order.
2. Put labels, or draw the shapes of different hand tools, on the tool board to show where every item goes. At a glance, everybody will be able to see where tools should be returned. This is good for maintenance.
3. For work that requires a lot of movement from place to place, design wooden boxes with good handles to contain your tools. Arrange the tools in order, and draw the shape of each kind on the front of the box.
4. If you keep many tools, develop a cabinet for storage. Put labels, or draw shapes, to show where each of the tools should be placed.
5. Store small tools or work items in special bins or trays with labels to prevent loss.

WAYS TO PROMOTE COOPERATION

Start with simple, immediate actions. There are many practical solutions, such as tool hangers made of bamboo, or drawings of the shapes of tools. The idea of providing a home for each tool is helpful for housekeeping, too. Invite ideas from your family, and share visible achievements.

SOME MORE HINTS

- Attach wheels to your tool cabinets or racks. They can then be moved to different worksites when necessary.

POINTS TO REMEMBER

Providing a “home” for each tool is a low-cost way to improve safety, health and efficiency in your work.

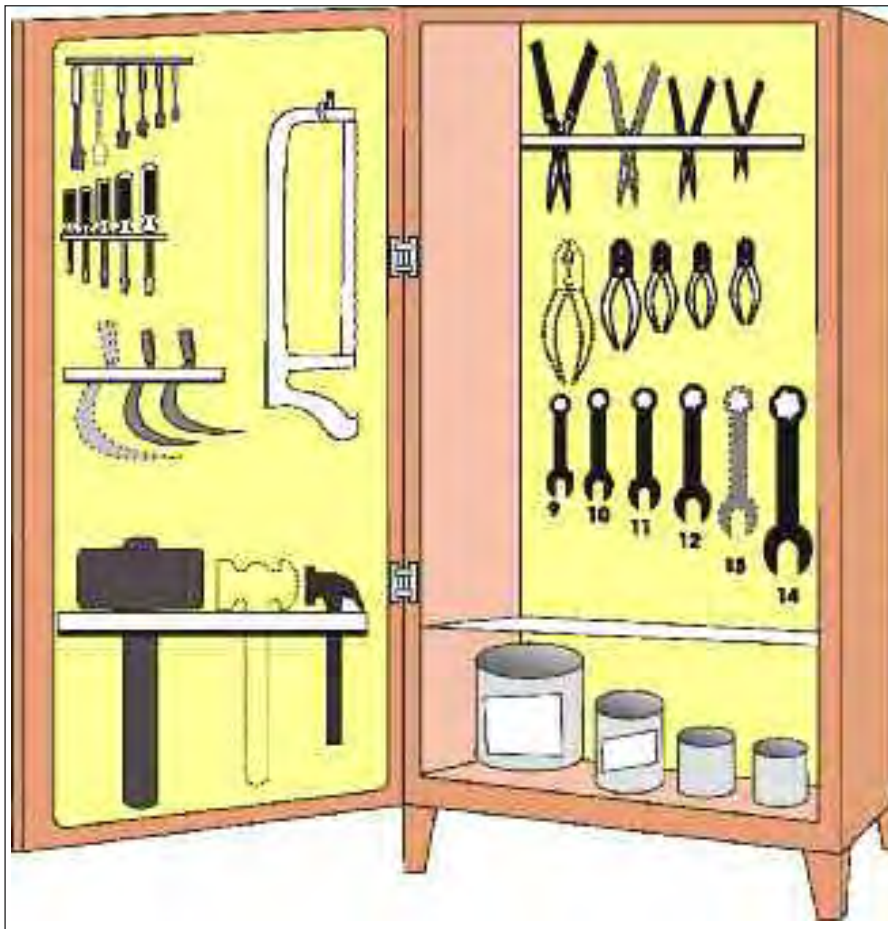

Figure 16a. A simple tool storage cabinet. Tools such as pliers, hammers and sickles are hung on both sides, and are easy to distinguish. As tools are marked and labelled clearly, it is easy to find the required work items.

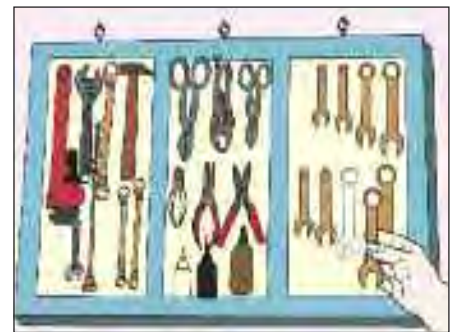

Figure 16b. Use a wooden board to fix tool hangers. Mark the shape of each tool clearly and distinctly.



Figure 16c. A mobile tools cart helps farmers ensure smooth workflow in different workplaces.



Figure 16d. Multi-level racks to hold agricultural tools. Store small tools or work items in special bins or trays with clear labels.

CHECKPOINT 17

Adjust the work height so that work is done at, or slightly lower than, elbow level.

WHY

Various agricultural jobs, such as sorting and packaging farm products, need appropriately designed workstations. Muscle strains and pains can be prevented, and efficiency increased. Good workstations can also simplify housekeeping jobs such as cooking and washing.

A working height at elbow level minimizes your muscular effort. This rule applies to both standing and sitting postures. Adjust the work surface to elbow level, or slightly lower than elbow level. Work can now be carried out comfortably, and efficiency and productivity will increase markedly.

When working at a height lower than elbow level, you need to bend your body trunk. This posture puts strains on your back, and could cause low-back pain. If the workstation is higher than elbow level, you have to keep arms and shoulders elevated. This will gradually cause stiffness and pains, and you will find it difficult to continue your work.

HOW

1. Look at your workstations, work tables and cooking devices at home. Adjust their heights to elbow level.
2. Adjust workstations to the height of the most frequent users.
3. One workstation may be used by many farmers together. Use a foot platform for short farmers and an item holder for tall farmers to adjust their work height to elbow level.
4. When you need to exert greater force, such as when cutting products or repairing tools, choose workstations slightly lower than your elbow level.

WAYS TO PROMOTE COOPERATION

Many farmers squat on the ground when sorting or packaging farm products. This posture causes strains and pain. Encourage your friends and neighbours to use appropriate workstations (chairs and tables), and to adjust the height to elbow level. The same principle can be applied to your family work. Discuss plans with your family members to use appropriate workstations. After changes, evaluate the benefits together.

SOME MORE HINTS

- Make sure that you can reach the plants or products easily from your natural standing position. Tools and containers should be within easy reach.

POINTS TO REMEMBER

Making arrangements to avoid bending or squatting postures greatly reduces pains and fatigue, and increases productivity.



Figure 17a. Adjust the work height to be at elbow level.



Figure 17b. Use a foot platform for short farmers if the workstation needs to be used by many farmers together.



Figure 17c. Change farming arrangements in the field to avoid strenuous bending postures as much as possible.



Figure 17d. Adjust the work height by using a stable foot platform corresponding to your elbow level.



Figure 17e. When greater force is needed for work, choose a work height slightly lower than your elbow height.

CHECKPOINT 18

Change farming arrangements in the field to avoid strenuous working postures as much as possible.

WHY

Farming work in the field is very often done at ground level. This requires the farmers to bend forward or squat down. As the work usually takes a long time, the farmers can easily get low-back pain and leg muscle fatigue. These pains and fatigue can be prevented, or at least reduced, by introducing arrangements to avoid bending or squatting postures.

There are a variety of new arrangements for doing farming work in natural standing postures, or while sitting on low seats. These arrangements relate to changes in ridges and furrows, or the ways in which crop plants are cultivated. By avoiding awkward postures, farmers can not only prevent pain and fatigue, but also increase productivity. Many such new arrangements are implemented at low cost. It is useful to learn from new ideas of farmers.

HOW

1. Change farming tools to have long shafts, so that work at ground level can be done in a natural standing posture. Attach an easy-to-grasp handle to make the work easier.
2. Make arrangements so that farm plants and products can be handled or picked at elbow level. This may require special arrangements for ridges or stands.
3. Provide special stands for growing farm plants. Adjust their height so that farming work and harvesting can be done in a natural standing posture.
4. Provide work tables suitable for handling farming plants or products. Adjust the work height to be at elbow level. Foot platforms are often useful for short farmers.
5. Use mobile seats for handling farm plants growing near ground level. Containers for farm products can be placed near the mobile seats.

WAYS TO PROMOTE COOPERATION

Visit farms where new arrangements for allowing farming work at elbow level have been introduced. Ask about changes in farming tasks, work efficiency and fatigue. Discuss which arrangements are most suitable for the plants you are growing. Discuss the design of new arrangements at your own farm with experienced farmers and local agricultural centres. Find cost-effective ways of making the necessary arrangements.

SOME MORE HINTS

- Make sure that you can reach the plants or products easily from your natural standing position. Tools and containers should also be within easy reach.

POINTS TO REMEMBER

Making arrangements to avoid bending or squatting postures greatly reduces pains and fatigue, and increases productivity.



Figure 18a. Provide easy-to-work facilities for growing plants so that bending postures can be avoided when harvesting and carrying farm products.



Figure 18b. Arrange work tables and trolleys so that work is done at elbow level.

Figure 18d. Use farming tools with long shafts and easy-to-grasp handles so that work at ground level can be done easily, in a natural standing posture.



Figure 18c. Arrange farming work at around elbow level. This is cost-effective, as strenuous bending postures can be avoided throughout the farming period.



CHECKPOINT 19

Use jigs, clamps or other fixtures to hold items while work is being done.

WHY

Safety and health risks arise when you use your hands to hold workpieces. For example, your hands may be in danger when you are cutting materials. You may have to work while bending forward deeply. If workpieces slip from your hands, it may cause injuries, damage products and waste time.

By using jigs, clamps or others fixtures, you can hold different sizes of work item steadily. Your hands are now free for any necessary manipulation, and therefore your work can progress more quickly and more safely.

HOW

1. Design and use convenient jigs and clamps to hold your work items. They are particularly useful for fixing parts and components of agro-machines, pumps, wheels or their hubs when repairing them.
2. Fix the jig or clamp tightly on the work surface or table, and adjust the height of the item so that you can work on it at or slightly lower than elbow level.

WAYS TO PROMOTE COOPERATION

Fixtures and clamps can be made locally, or purchased for reasonable prices. Promote the habit of using fixtures among villagers when cutting and repairing. Find good solutions, and facilitate the exchange of experiences.

SOME MORE HINTS

- It is important to adjust the fixing forces to be strong enough to secure the workpieces held in the fixture or clamp.
- File any sharp edges of the clamp to avoid injuring your hands.

POINTS TO REMEMBER

Simple holding devices will greatly increase your comfort and safety while working.



Figure 19a. A low-cost fixture, made of wood, to hold workpieces for planing.

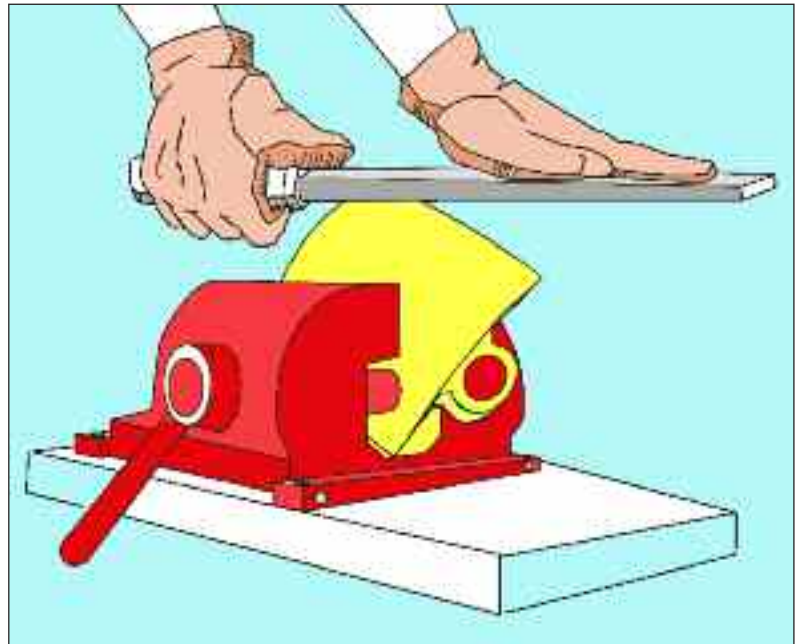

Figure 19b. The use of a jig or clamp allows both hands to be manipulated freely and to work productively.



Figure 19c. Use a fixture to hold wheel hubs or axles when they are detached for repair or maintenance.

CHECKPOINT 20

Eliminate work at height, or provide a safe, stable platform.

WHY

Work on farms is often done on elevated platforms or structures. Working at height means there is a risk of falling, which can lead to serious injuries and even fatalities. The utmost care must be taken to prevent falling accidents.

Where possible, eliminate work at height. If this is not possible, it is essential to provide a safe footing for work in an elevated position, with a good platform and protection against falls. Access routes must be safe, too. Protection from falls also makes the work more reliable and more efficient.

When working at heights of 2 m or more above the ground, safety belts and precautions against falls are essential.

HOW

1. Provide a safe, stable platform for work done at height. Confirm that the platform is safe by getting advice from experienced persons.
2. Attach stable guard rails to the platform that can prevent falls from it.
3. There are cost-effective ways of eliminating work at height by simple arrangements, such as long tool handles or limiting the plant height.
4. When using a ladder to reach a high place, it should be securely lashed or otherwise fastened to prevent it from slipping.
5. Make sure that workers working higher than a designated level (2 m or more, for example, depending on regulations) wear a safety belt or harness securely connected to a stable structure.
6. Establish safe practices for piling or placing loads on high platforms or scaffolds to prevent their falling.

WAYS TO PROMOTE COOPERATION

Identify, together with your neighbours, farming work done at height. Discuss jointly whether this work can be eliminated, or at least protected satisfactorily. Consider alternative arrangements to avoid the work at height, such as long handles, lift trucks or changing the plant height. Make sure, through discussion, that safeguards are provided against the danger of falling.

SOME MORE HINTS

- Avoid working at elevation during bad weather.
- If necessary, erect a safety net to prevent injuries due to falls.

POINTS TO REMEMBER

Prevent serious falling accidents by providing safe platforms, proper guards and safety belts. Safer work means increased productivity.



Figure 20a. Often, simple arrangements can replace work on an elevated platform by safer work at ground level.

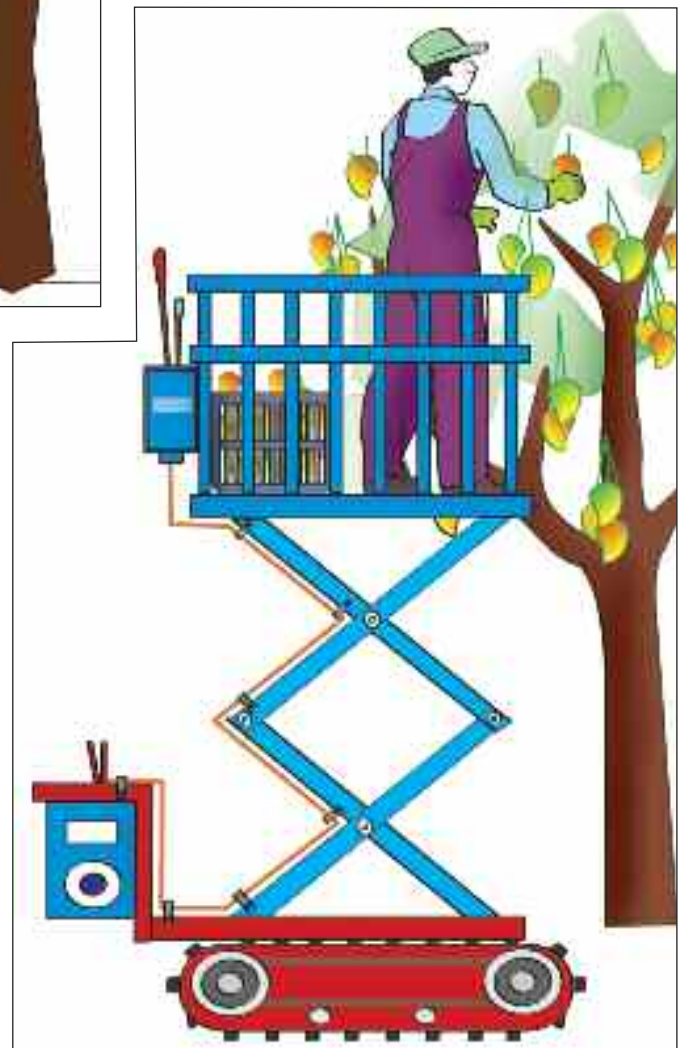

Figure 20b. Mechanical lifting platforms with proper safeguards can help minimize risk and increase efficiency.

CHECKPOINT 21

Make switches and displays easy to distinguish from each other.

WHY

If switches and displays are similar, people can easily make mistakes. This can be avoided by making them easy to distinguish from each other, for example by their positions, shapes or colours. Switches and displays that are easy to distinguish help prevent accidents and increase work efficiency.

The various switches and displays can be easily identified with suitable labels. This is a typical low-cost method to make work safer and more productive.

HOW

1. Use different positions, sizes, shapes or colours for the various switches or displays.
2. Use systematic colour-coding to differentiate different types of switch or display. This helps you easily distinguish the various machines, tools, pipes and other items connected with each switch or display.
3. Put labels indicating the types or functions of operation or work process near the corresponding switches or displays.
4. Make the characters and numbers in the labels large enough that they can be easily read at a distance.
5. Colour emergency switches red; make them clearly visible and easy to reach.
6. Locate the most important switches and displays where they are easily seen and can be reached from the normal working position.

WAYS TO PROMOTE COOPERATION

Discuss with family members and neighbours which kinds of switch or display are likely to cause confusion. Try to put colours and labels on these switches or displays, and decide which colours are most suitable for distinguishing them from each other. Improve the labels so that the various switches and displays are easily identified in terms of their purposes and functions.

SOME MORE HINTS

- Limit the number of colours to help people distinguish them without mistakes: no more than three.
- Labels can be placed above, underneath or at the side of controls, as long as they are clearly visible.
- Put clearly visible stripes around the switches or displays that are most important.

POINTS TO REMEMBER

Use colours and easy-to-read labels to make it easy to distinguish switches or displays from each other.

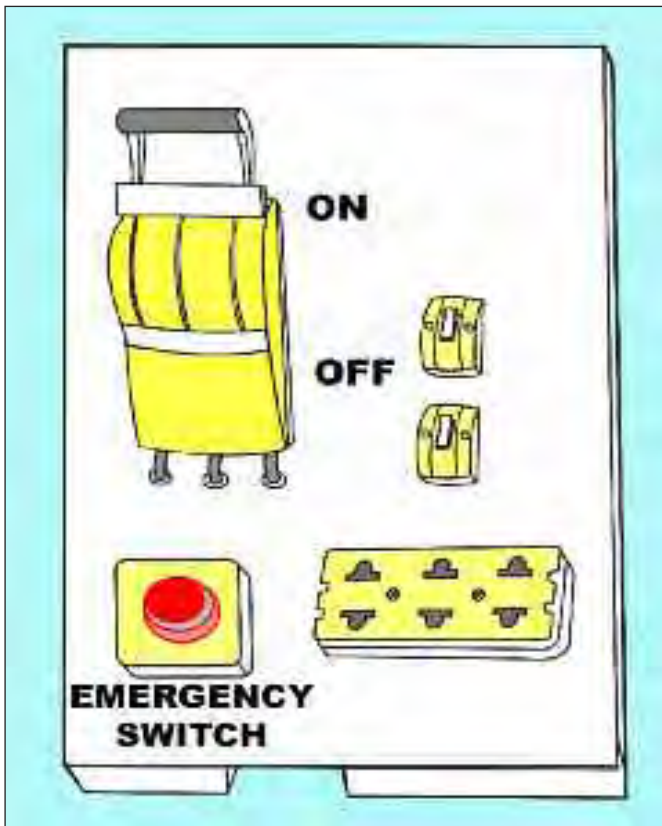

Figure 21a. Make the main and emergency switches distinct, and easy to operate.

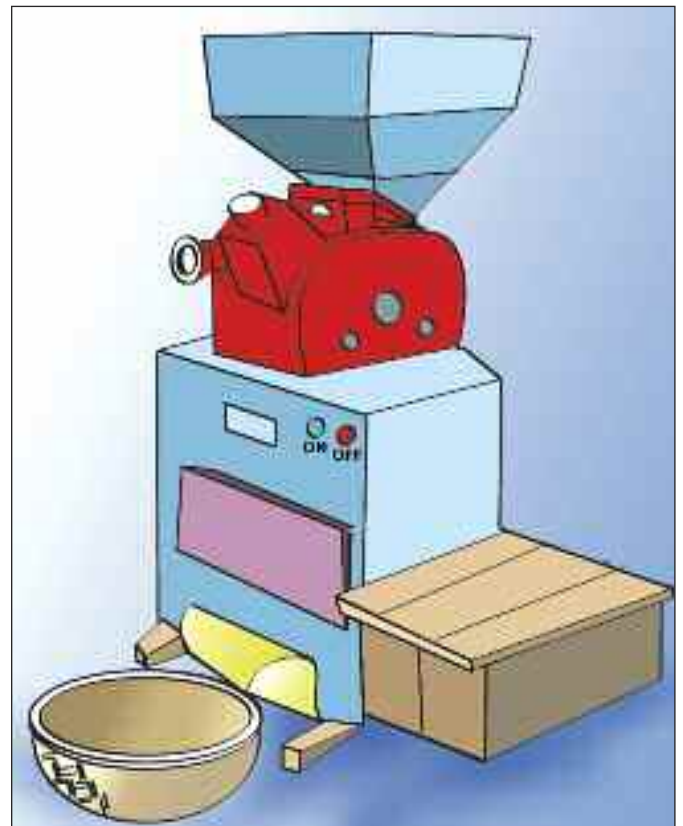

Figure 21b. Switches should be positioned so that they are easy to reach and easy to operate.

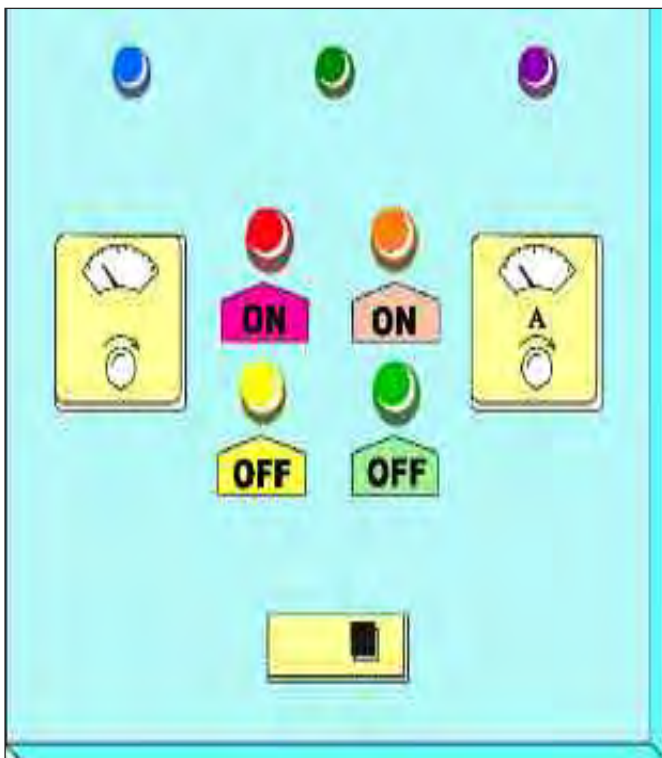

Figure 21c. Different colours and easily read labels can help distinguish switches easily and without mistakes.

CHECKPOINT 22

Choose work methods that alternate standing and sitting, and try to avoid bending and squatting postures as much as possible.

WHY

Alternate standing and sitting while working. Changing work postures can allow particular groups of muscles to rest after working, so as to avoid overuse. Muscle fatigue can be prevented, and the quality of work will be improved.

Continuing a single posture is strenuous.

Continuous standing will cause pains in the shins, feet and back, and then may affect the whole body. Long periods of sitting will increase strain on the low back, and so can cause low-back pains.

It is particularly important to avoid strenuous work postures such as bending and squatting. These postures place a strain on the back and cause pains, making you prone to mistakes and accidents. Frequent changes of work posture can help prevent such strains and pains.

HOW

1. Provide a chair or stool close to your working position. In a standing position, you can sit on the stool by simply leaning. Choose light materials to make such a chair easy to move.
2. Vary the jobs carried out by one farmer so as to change his or her work posture.
3. Minimize bending postures while working. Various tools will help you. For digging or cultivating, choose tools with long handles. When carrying water, use a yoke.

WAYS TO PROMOTE COOPERATION

Exchange ideas and experiences of practical solutions with your neighbours. Find an opportunity to work together with your neighbours to vary jobs and to avoid a single strenuous work posture. For example, during harvesting rice, you and your neighbours may alternate between cutting rice and carrying bundles of rice. Work together, and evaluate the effectiveness.

SOME MORE HINTS

- Standing stools or chairs should be appropriate in size, and portable. Large, heavy stools may disturb your work.
- If it is difficult to alternate standing and sitting, just try to provide standing workers with chairs for occasional sitting, and provide seated workers with an additional space where some secondary tasks can be done while standing.

POINTS TO REMEMBER

Continuing a single working posture for long periods is disadvantageous to your health. Find a way to alternate standing and sitting for greater efficiency and comfort.



Figure 22a. Provide a chair or stool near the work area; from a standing posture, farmers can occasionally sit on the stool simply by leaning.

Figure 22b. Choose work methods to alternate between standing and sitting.



Figure 22c. Where possible, arrange standing work done at elbow level to replace low sitting postures.

CHECKPOINT 23

Provide stable chairs or benches of the correct height, with sturdy backrests, for seated work and for occasional sitting during standing work.

WHY

Farmers have many jobs that need to be done while sitting. Appropriate chairs or benches with sturdy backrests make your work much easier. You can relax your back muscles by leaning against a backrest.

A seated posture may seem more comfortable than standing, but sitting for a long time can cause strain and pains in your back. A backrest allows your back muscles to relax from time to time, reduces tiredness and increases your job satisfaction.

HOW

1. Walk around your village. Find jobs that are being done while sitting, or would be better if done while sitting. Find out the kind of chairs that are appropriate for farmers to use.
2. Attach a sturdy and appropriate backrest to chairs for seated farmers.
3. Benches should also have attached backrests. Wooden or bamboo benches with arm and back supports will help group work, such as sorting farm products and picking up seeds.
4. Adjust the work surface height to the individual's elbow level.

WAYS TO PROMOTE COOPERATION

Chairs with a backrest don't cost much. You will surely find many good existing examples in this regard in your village. Learn from these examples. How are the chairs with backrests used? How are they made? With what materials? Then go on to promote chairs with a backrest to other villagers. Start with simple actions using available local materials, such as repairing wobbly chairs or attaching sturdy backrests. Encourage your neighbours to develop the habit of using chairs with a backrest when working in a seated position.

SOME MORE HINTS

- Armrests can also be useful for precision jobs that need a sustained arm position.
- Chairs with a backrest might not be best for work that requires frequent body movements. If so, use stools or chairs without a backrest.
- When long periods of sitting are needed, use a cushion or a round pillow behind your lower back. It will help to reduce the strain on your back.

POINTS TO REMEMBER

Appropriate chairs using sturdy backrests will increase the quality of your work.



Figure 23a. Choose stable chairs with sturdy backrests for seated farmers sorting and packaging farm products.



Figure 23b. Change work that is usually done at ground level, such as raising young trees or sorting farm products, so that it can be done in a seated position, with the working surface corresponding to elbow level. Use comfortable chairs with backrests.



Figure 23c. A suitable sitting posture for work that requires care and concentration: table at or below elbow height; sturdy chair with backrest.

CHECKPOINT 24

Choose tools that can be operated with minimum force.

WHY

Well-designed, appropriate tools can greatly reduce your workload and improve your productivity. Often delicate movements are required in operating tools. Even light fatigue could hamper good work output. When using heavy and bulky hand tools, you will become fatigued even more easily, resulting in low efficiency, or even accidents.

The hand tools that farmers need vary, depending very much on their work. Rice reaping and fruit picking need sharp knives with good handgrips. Branch grafting and thinning out are precision work, which needs accuracy in tool use. By contrast, greater force is required for pounding, smashing and cutting. These need strong tools with sturdy handgrips.

There are many ways to improve your tools, and thereby your safety and health.

HOW

1. Choose tools that are light (but still sufficiently strong), to reduce the workload on your arm and hand muscles. Larger tools, such as hoes and ploughs, need handles of appropriate lengths. Attach sturdy handgrips to the tools so they can be held safely.
2. Design tools that can ease your work. For example, a manual line-sowing machine was invented and has been used in Viet Nam. Farmers no longer need to hold and carry heavy baskets of rice seeds in the rice field.
3. Rotating work-stands or similar devices at an appropriate height will minimize the need to lift heavy objects. They are particularly helpful when repairing and maintaining machines and other equipment.

WAYS TO PROMOTE COOPERATION

You can find easy-to-use agricultural tools designed by local people. Such tools can save energy and farmers' time by improving safety, health and productivity. Discuss together and exchange experiences on how to invent convenient new tools using locally available resources. Share good solutions with your neighbours.

SOME MORE HINTS

- Avoid overuse of a particular group of muscles when using tools. Choose and design tools that allow you to use many muscles in a good, balanced way.

POINTS TO REMEMBER

Appropriately designed tools and devices help reduce fatigue and increase productivity.



Figure 24a. Use a line-sowing machine. The machine is rolled on the field; the sown rice grows in lines, convenient for fertilizing and weeding.

Figure 24b. Use a hand-reaping machine to reduce the workload on your arm and hand muscles. Attach sturdy handgrips to the tool to secure a safe grip.

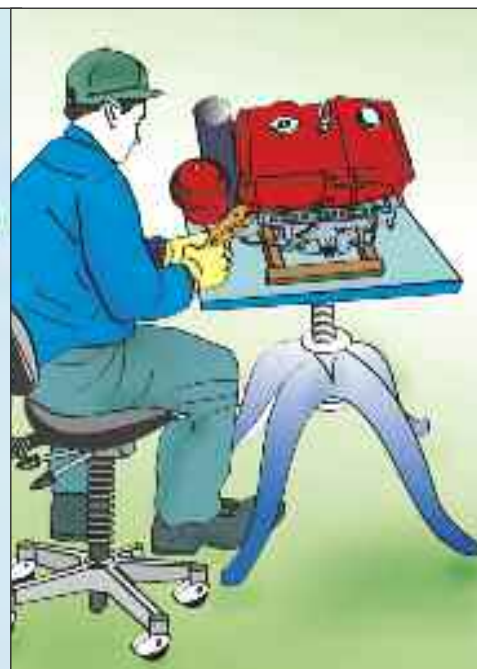
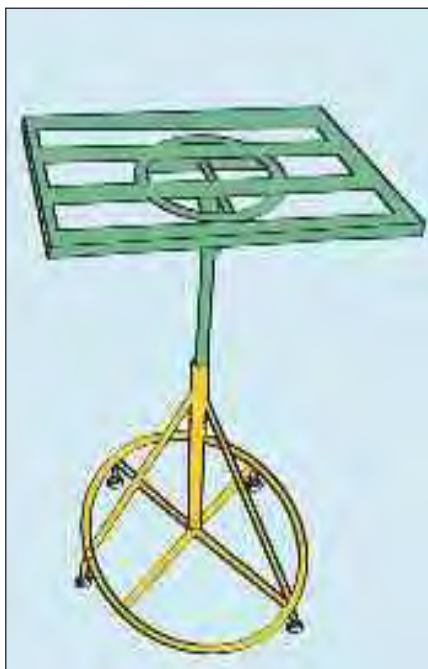

Figure 24c. Design a rotating work-stand at an appropriate height to minimize the lifting of heavy objects.

CHECKPOINT 25

Provide tools with appropriate grips that have adequate friction.

WHY

The effective use of hand tools is greatly influenced by the shape and friction of their grips. A good grip allows the worker to use the tool with firmer control and less force. This improves the quality of the work being produced, and reduces fatigue and accidents.

For firm holding of a hand tool, the friction of the grip is important. A grip with appropriate friction will help the user hold the tool with appropriate force, and to use it accurately and in the correct direction.

HOW

1. Select tools that have grips and are easy to grasp. If a single handle of the tool is designed to be grasped by the whole hand (i.e. the four fingers reach around the handle and are locked by the thumb over the index finger), ensure that the handle diameter is 30–40 mm.
2. Make sure that the grip of the tool has an appropriate shape and sufficient friction. You can confirm this by a trial use of the tool.
3. Confirm that the grip has an appropriate length, and is suitable for use with gloves if necessary. Make sure that the handle is at least 100 mm long; 125 mm is more comfortable. Use a handle at least 125 mm long if gloves are worn.
4. Purchase separate tools suitable for right-handed and left-handed workers.
5. Sharp or dangerous tools might injure the fingers if the hand slips. Make sure that such tools are fitted with appropriate guards.

WAYS TO PROMOTE COOPERATION

The problems associated with the use of hand tools can be easily found through trial use. Discuss whether the shape and friction of a tool are appropriate before purchasing it. If the tool is already in use and you feel the grip is not firm enough, try to increase friction by

covering the gripping surface with anti-slip tape or other materials, or attach an appropriate guard. Always examine the safety of the tool in actual use. Listen to the experienced users of the tool in your neighbourhood.

SOME MORE HINTS

- Gloves increase the size of the hand and change the surface friction. If a tool is to be used while wearing gloves, try out its grip size and its friction by using it with gloved hands.

POINTS TO REMEMBER

Use tools with grips suited to your hands, with proper size, shape and friction.



Figure 25a. Grips help in handling tools easily and safely.



Figure 25b. The grips of tools should have the correct shape and adequate friction.



Figure 25d. The handles of tools should have adequate sizes and friction as they may be used in different field conditions, often in wet weather.



Figure 25c. Sharp tools might injure the fingers if the hand slips. Make sure that such tools are designed properly.



Figure 25e. The tool grip should be of the proper thickness, length and shape.

CHECKPOINT 26

Attach labels, signs and symbols that are easy to understand, in order to avoid mistakes.

WHY

Many mistakes occur during work when work items, tools, machines, switches or displays are similar, or are positioned in a confusing way. Labels and signs can greatly reduce such mistakes.

Attach labels, signs or symbols to clarify which objects belong to which functions. It is best to use letters, signs or symbols that are easy to understand and familiar to the users. This reduces the unnecessary stress that people may feel in identifying the correct objects, and will contribute much to productive work.

HOW

1. Attach labels and signs close to the objects in places where people often look: for example, close to the equipment they belong to, or in front of each user.
2. Use only signs or symbols that are familiar to the users. You can make sure of this by asking the people who are expected to see them during work whether they understand the signs or labels.
3. Make the lettering large enough so that people can read it easily at a distance.
4. Put labels for objects and switches immediately above, underneath or to the side, so that it is clear which label corresponds to which object or switch.
5. Make the written message clear and short. Avoid confusing or lengthy text.
6. Use the language that can be understood by the users. Where there is more than one language group, it may be necessary to use different languages in labels and signs.

WAYS TO PROMOTE COOPERATION

The use of labels is very effective for preventing mistakes. Try some labels that you think are appropriate for distinguishing different containers, tools, switches and materials. Then discuss among neighbours and family members which kinds of label and which types of lettering are easiest to understand. Keep the labels clean and easy to read.

SOME MORE HINTS

- Where appropriate, use different colours or shapes for different labels or signs.
- Lettering 1 cm high is usually sufficient for labels at workstations.
- Make the message short, and easy to understand at a glance.

POINTS TO REMEMBER

Easy-to-understand labels and signs greatly reduce mistakes and save time.



Figure 26a. Signs and symbols that can be easily understood help reduce mistakes.

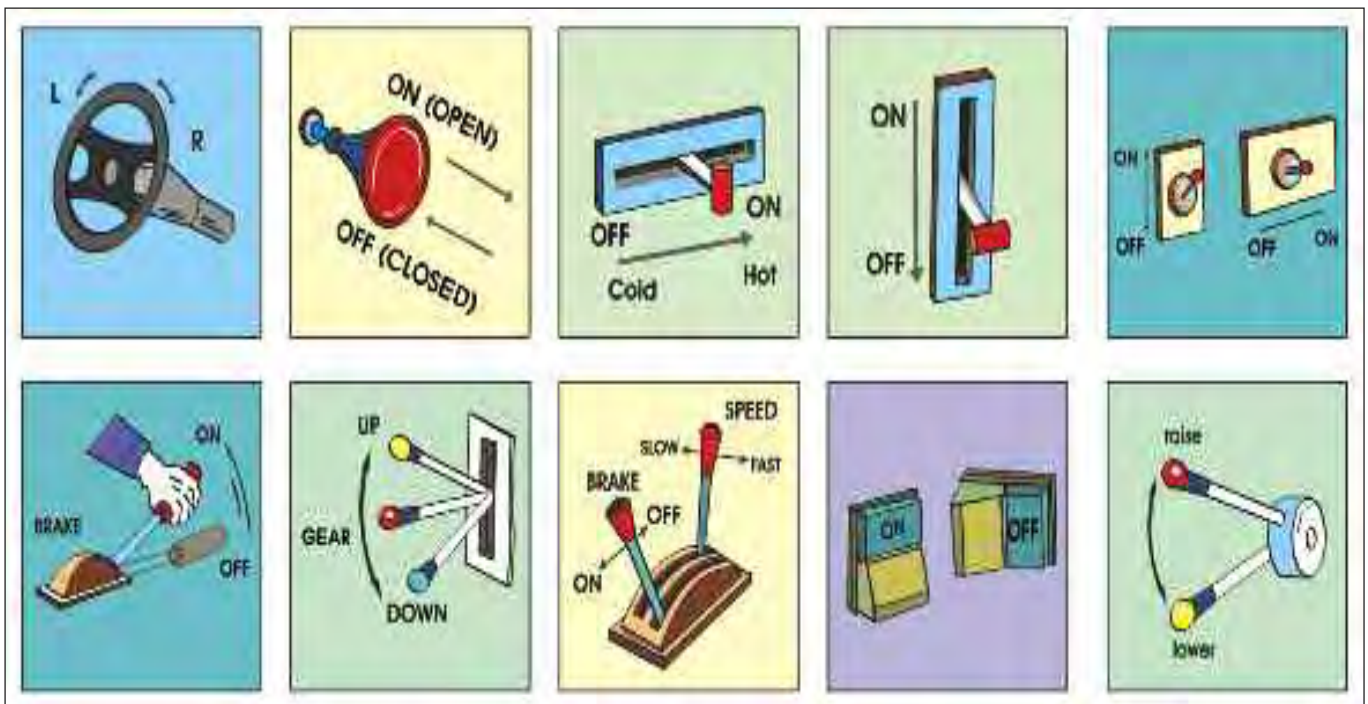

Figure 26b. The directions for operating different kinds of control generally correspond to the directions of movement most easily understood by local people. It is useful to attach labels to indicate clearly the necessary directions.

CHECKPOINT 27

Provide adjustable work surfaces for workers dealing with objects of various sizes.

WHY

Farmers deal with materials, products and containers of different sizes at work tables or stands. It is important to keep the height of the operating hands at around the elbow level of each individual worker. It is useful to adjust the height of work surfaces so that the work is done at elbow level even if the size of the objects changes.

Work surfaces that are too high or too low increase muscle pains and fatigue. Work surfaces that are too high lead to stiffness and pains in the neck and shoulders. Work surfaces that are too low cause low-back pain. This happens in both standing and sitting postures. Work surfaces adjusted to elbow level prevent these serious effects and improve work efficiency.

HOW

1. Adjust the height of work surfaces to be at elbow level, taking into account the size of the objects handled by workers. If force has to be exerted on the objects, the working height should be somewhat lower than elbow level.
2. Where possible, use a height-adjustable work table. Adjust the work surfaces to be around elbow level for each individual worker. If an adjustable table is not available, provide floor platforms for short workers and work item stands for tall workers.
3. Where appropriate, provide a rotating stand that makes it easy to work on an item from different directions.
4. Where a group of people work at the same work table, or along a long workstation, make sure that elbow-height work is done by individual workers by providing floor platforms or work item stands.

WAYS TO PROMOTE COOPERATION

It is much easier to adjust working height than people normally think. Because machines or tables are involved, people tend to think that it is too expensive, or even impossible, to change working height. This is not true. Learning from the above examples, use your own ideas. Always discuss appropriate arrangements for different workers, taking into account the different sizes of objects that they are required to handle.

SOME MORE HINTS

- Make an exception for high-precision work carried out while sitting. The object can be raised slightly above elbow level.
- If the same work table is used for both standing and seated work, provide a higher working surface for standing work. This is usually achieved by inserting platforms or fixtures under work items handled by standing workers.

POINTS TO REMEMBER

Apply the “elbow rule” by taking into account the different sizes of objects.



Figure 27a. Adjust work tables to allow for the right work height according to the type of work being done.



Figure 27b. A rotating stand makes it easy to work on an item from different directions.

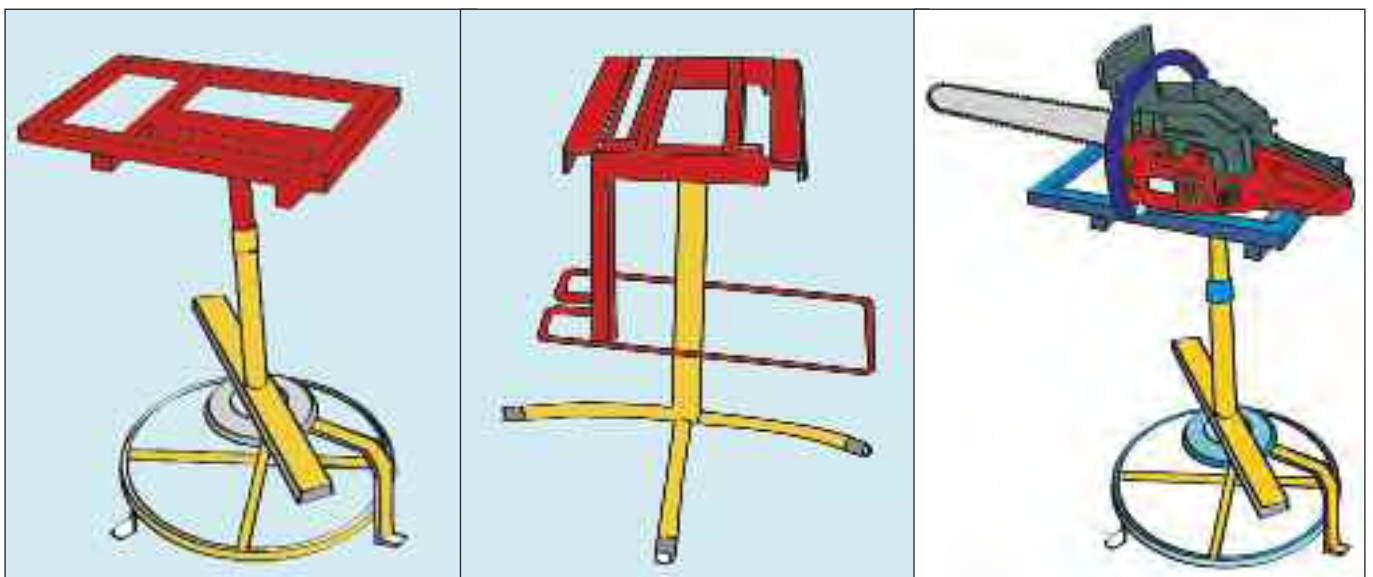

Figure 27c. Adjustable work-stands are useful, because the working height can be changed for different workers or types of work.

CHECKPOINT 28

Use portable stepladders to prevent falls from unstable, elevated places.

WHY

Sometimes during agricultural work a farmer needs to reach an object above head level. When precision work is required overhead, portable stepladders should be used. When this type of work occurs only occasionally, the ladder used may not be readily available, and people try to use makeshift arrangements. This can cause injuries, often with serious consequences. It is useful to provide safe, portable stepladders.

A stepladder, properly placed on site, can provide a foot stand that is much more stable and safer than any makeshift arrangement. By training farmers and farm workers in the safe use of portable stepladders, you can ensure safe work of good quality.

HOW

1. Select portable stepladders that are easy to carry and handle, and are safe in use. Consult experienced farmers or specialists about the safe and efficient types of stepladder.
2. The need to use portable stepladders in farm work may arise unexpectedly. By keeping them at designated places, you can ensure they are available when needed.
3. Maintain stepladders properly.
4. Get training in the proper use of stepladders from the suppliers, or from experienced workers. Take care to prevent injuries when working at an elevated height and injuries from the mishandling of stepladders.
5. Ensure that stepladders are used correctly – particularly the arrangements for avoiding sudden collapse.

WAYS TO PROMOTE COOPERATION

Various different shapes of stepladder are available for agricultural work. Learn from experienced neighbours or specialists about the appropriate types of stepladder, and about their safe use. Organize training and retraining sessions on the maintenance and safe use of stepladders on your farm, involving all the people who may use them.

SOME MORE HINTS

- Establish safe practices for all people to follow strictly when using portable stepladders in different types of overhead work.
- Inspect stepladders at regular intervals to ensure safety in their use.

POINTS TO REMEMBER

Portable stepladders are useful for work to be done safely at elevated levels.



Figure 28b. Stepladders of different shapes are available. Use ladders with arrangements for avoiding sudden collapse.

Figure 28a. Portable stepladders are useful for work to be done at elevated levels.

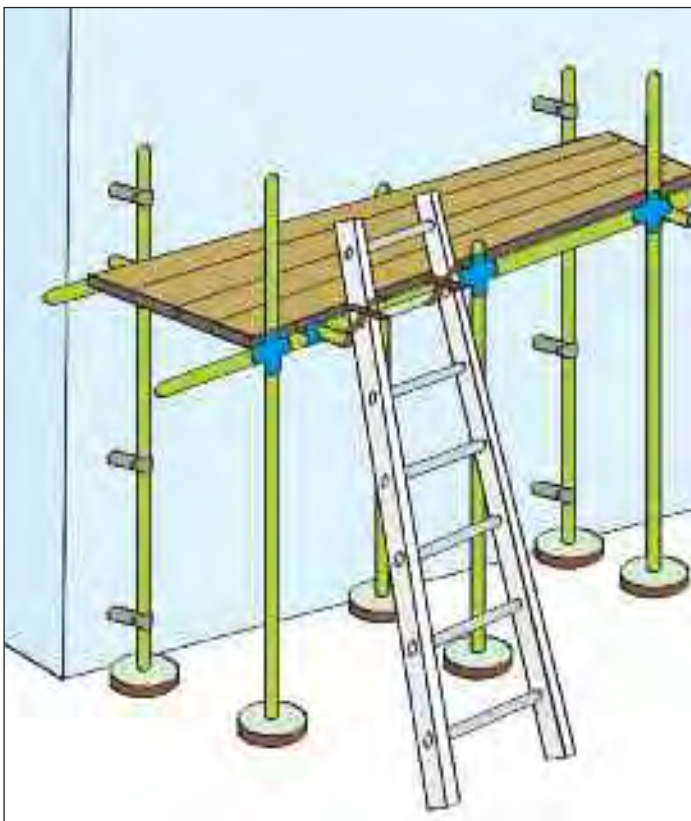

Figure 28c. Ladders for reaching an elevated platform should be securely fastened.

Machine safety

Farmers use many kinds of machine in farm work. These machines are very useful, but they can also be dangerous. There are practical, simple solutions to reduce the risks of accidents with machines. The proper use of guards, safe feeding devices and good maintenance are the keys to the safe use of machines. Electrical accidents are another serious safety problem among farmers in many countries. In this chapter, practical measures are presented to ensure the safe use of machines, including the safe use of electrical equipment.



CHECKPOINT 29

Purchase machines that incorporate the necessary safety guards and precautions.

WHY

Agricultural machines are large investments that help you increase productivity. However, they may also cause trouble and accidents when some of their parts are not properly guarded. Before you purchase a machine, study its safety aspects carefully to identify all possible dangers. Make sure all dangerous parts are well guarded.

Regular maintenance keeps your machinery safe and working properly. Check all machine parts carefully. Particular care is needed for rotating parts, detachable guards and electrical wires.

HOW

1. Before you purchase a machine, study and check it carefully. Make sure that all moving parts are well guarded, and that electrical wires are well protected. Check whether all feeding and ejection parts work safely. Switch the machine on and test it to see whether it runs well and safely. Ensure that your hands are free from danger while the machine is in motion.
2. Fix maintenance days to be held at regular intervals. Develop a maintenance diary, and record the condition of your machines.
3. Ensure that protective guards and safety controls are checked carefully and regularly.
4. Maintenance should only be carried out by qualified and experienced persons. Call for assistance from technical specialists in your village if you have any doubt. Alternatively, get training in how to operate the machine safely and how to do the proper maintenance. Machinery sellers or local agricultural experts can be helpful here. Without proper training and sufficient experience, machines could be a danger to you and your family.
5. While a machine is being maintained or repaired, it *must* be switched off and the electrical supply disconnected. Hang a suitable notice on the machine: for example, "DANGER, DO NOT OPERATE".

WAYS TO PROMOTE COOPERATION

Your village may have people who are experienced in selecting safe machines, and in maintaining machines in good condition. Learn from them. If possible, ask them to conduct short on-site training for other farmers. Recognize that farmers who maintain machines play a very important role for villagers. Neighbourhood cooperation is necessary to promote the safe use and maintenance of machines.

SOME MORE HINTS

- If you find an inexpensive machine, check its safety aspects even more carefully. Once accidents occur, the costs can be high.

POINTS TO REMEMBER

Only safe machines can contribute to higher productivity. Machines are not inexpensive: study their safety aspects carefully before purchasing them.

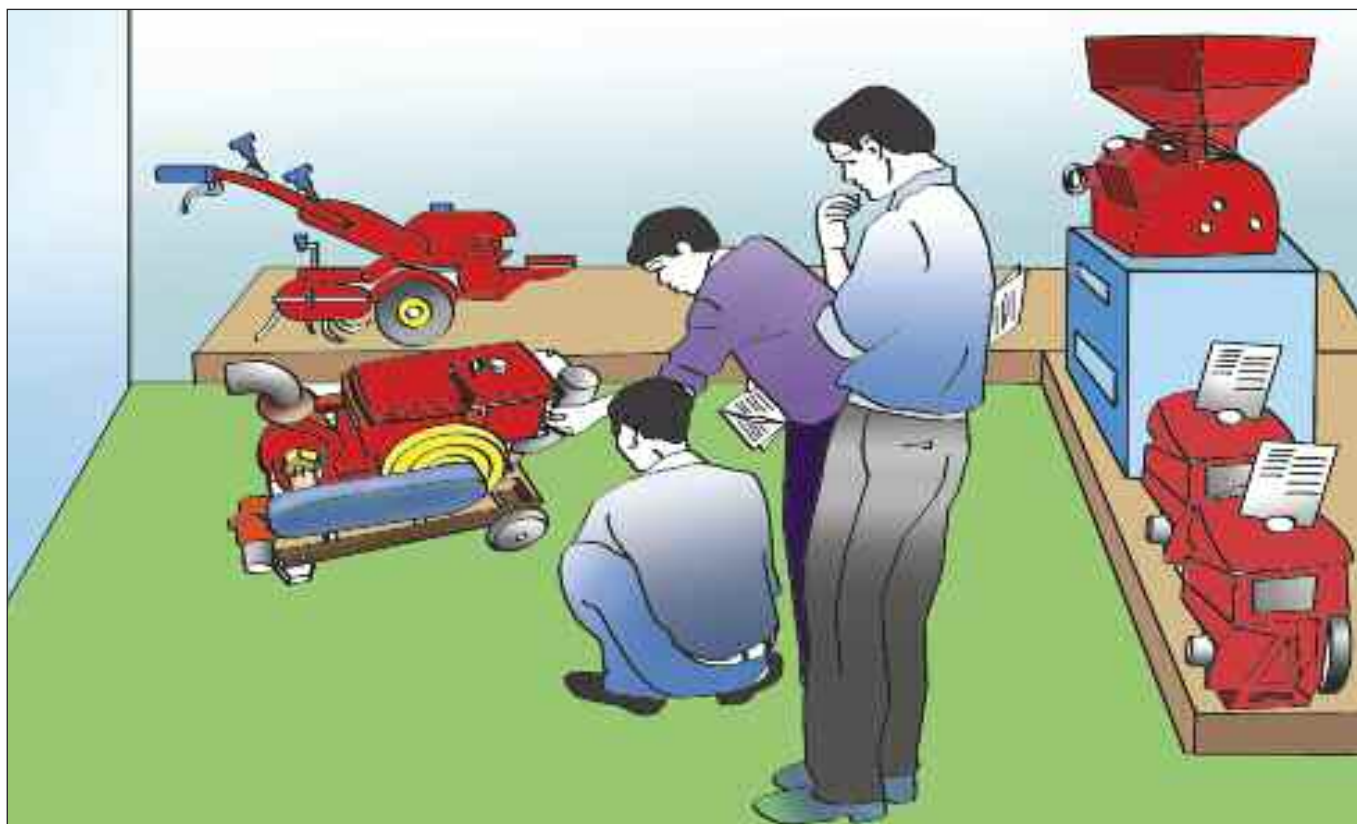

Figure 29a. Purchase pumps or engines in which all moving parts are carefully protected.

Figure 29b. Make sure that machines to be purchased meet all the necessary safety requirements.

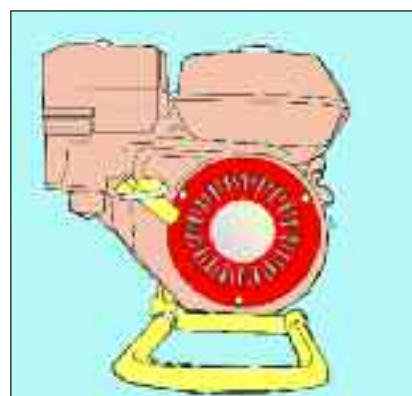

Figure 29c. Check both safety and health requirements when purchasing an agricultural vehicle.



Figure 29d. Only a qualified person should do maintenance of machines.



CHECKPOINT 30

Attach proper guards to the dangerous moving parts of machines.

WHY

The moving parts of machines pose accident risks to farmers. Serious injuries could occur from gears, rollers or belts. Without guards, dangerous items such as sharp objects and hot metal may even fly out from moving parts. Simple, hand-made guards can greatly reduce such risks.

Unguarded machines could harm not only users, but also visitors and family members (often children) who may pass by. The risks can be even higher for them, since they don't understand how the machine operates or what precautions are necessary. Machine guards can protect not only you, but also your family members and your friends.

HOW

1. Make guards and covers for the moving parts of machines. Use available materials such as wood or pieces of steel. Select strong, durable materials, and make the guards and covers difficult to be removed by children or non-maintenance people.
2. Guards and covers should be detached for repairs and maintenance only by experienced and qualified people. Follow the safe maintenance procedures.
3. If you need to observe the operation of a machine inside the guard, use a transparent material for the guard, such as plastic or a metal mesh.
4. If machines are located in areas where many people are passing by, install fences made of metal, or sturdy wood or bamboo, to limit access to them.

WAYS TO PROMOTE COOPERATION

Look around, together with your neighbours, at the various jobs done by agricultural machinery in your village. Identify which machines are used, where, and when. Identify the hazardous parts of machines, and list the machines that need appropriate guards. Discuss suitable solutions and procedures. If necessary, attach appropriate guards, using locally available materials if possible.

SOME MORE HINTS

- Guards must be fixed tightly to machines. If temporary or removable guards are not properly fixed, they could cause serious accidents to farmers. Before operating a machine, carefully check each nut and bolt of the attached guards. If necessary, tighten them again.

POINTS TO REMEMBER

Working near the moving parts of machines is very dangerous. The best protection is not to instruct farmers to avoid a machine, but to preventing contact with it by attaching guards.

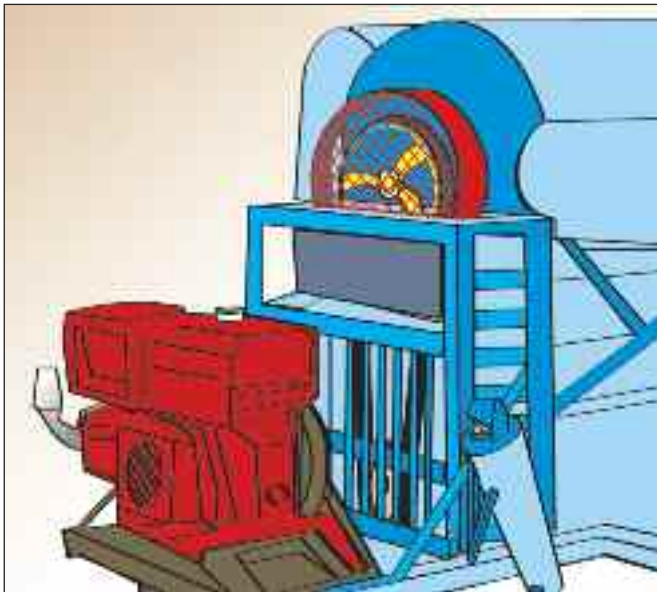

Figure 30a. Safety guard made from locally available materials. If necessary, use transparent materials such as metal mesh to make guards, so that tasks can be clearly observed.



Figure 30b. Special guards are necessary for hand-held powered tools to protect the hands and feet from unexpected movements of the tools.

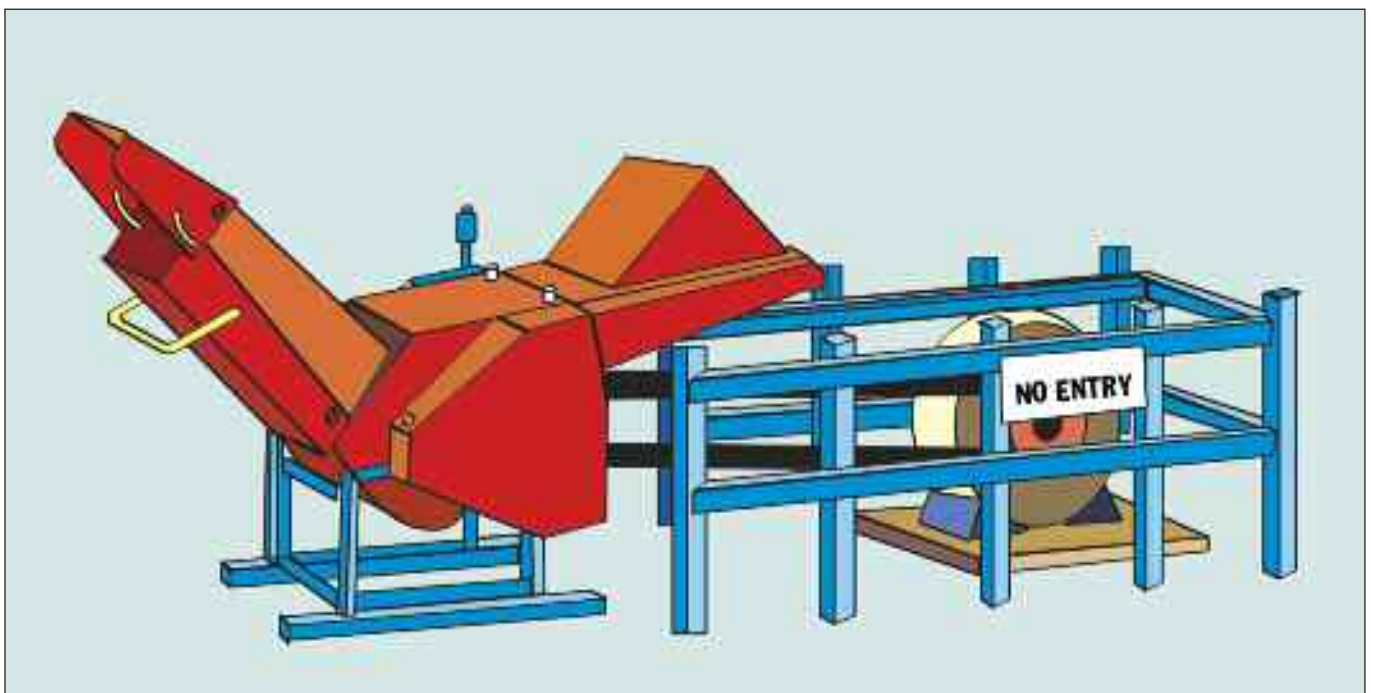

Figure 30c. Install fences to limit access to machines located in areas where people pass by.

CHECKPOINT 31

Use appropriate feeding devices to avoid danger and increase production.

WHY

Your hands are at great risk when feeding materials into machines. Sometimes farmers have lost their hands, or even their arms, while feeding crop bundles into threshing machines. The same dangers exist when working with milling, grinding or husking machines. A minor mistake can immediately result in injury to your hand, an important part of your body. Safe feeding devices can significantly reduce such risks and help prevent serious accidents.

As well as providing safety, appropriate feeding devices can also speed up your work. Repetitive motion of your arms and hands while feeding will cause fatigue and make your work slow. Simple gravity or automatic feeding mechanisms make the work much easier, and save your working time. Productivity will consequently increase.

HOW

1. Design gravity feeding devices in the form of a chute. The feeding device should be fixed firmly to the machine. From the opening of the device, raw materials will slide into the machine. This design is particularly useful for threshing machines.
2. Design funnel devices, and place them close to the feeding mouth of the machine. The weight of the farm products will push them into the machine. This mechanism is good for pressing, milling or grinding of farm products.

WAYS TO PROMOTE COOPERATION

Walk around your village and local farms. You will find some feeding devices used by your neighbours. How have they been invented and used? Share technical experiences with your neighbours. Discuss your machines with them, and design and improve your feeding and ejection devices together.

SOME MORE HINTS

- When fitting feeding devices to your machine, make sure that they don't interfere with existing guards and other safety devices on the machine.
- Regularly inspect and maintain feeding devices.

POINTS TO REMEMBER

Use convenient feeding devices to avoid accidents and improve your productivity.



Figure 31a. Feeding device in the form of a conveyor which carries bundles of rice into the dangerous part of a threshing machine.

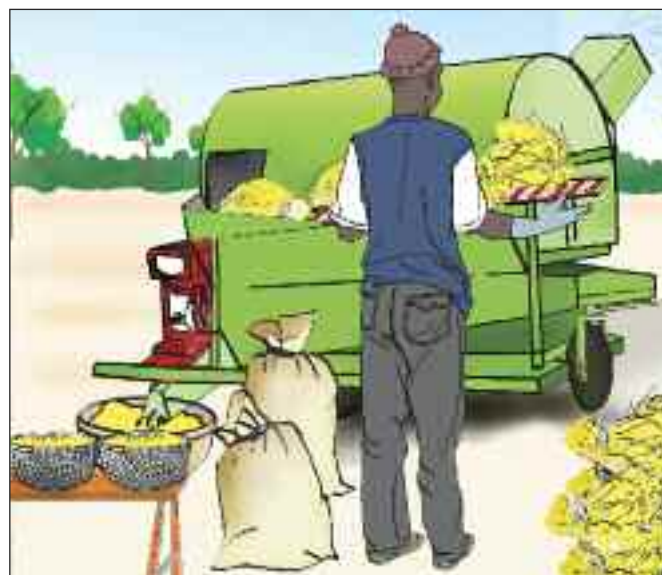

Figure 31b. The feeding part of the machine can be made higher, so that the work is done in a natural standing posture.

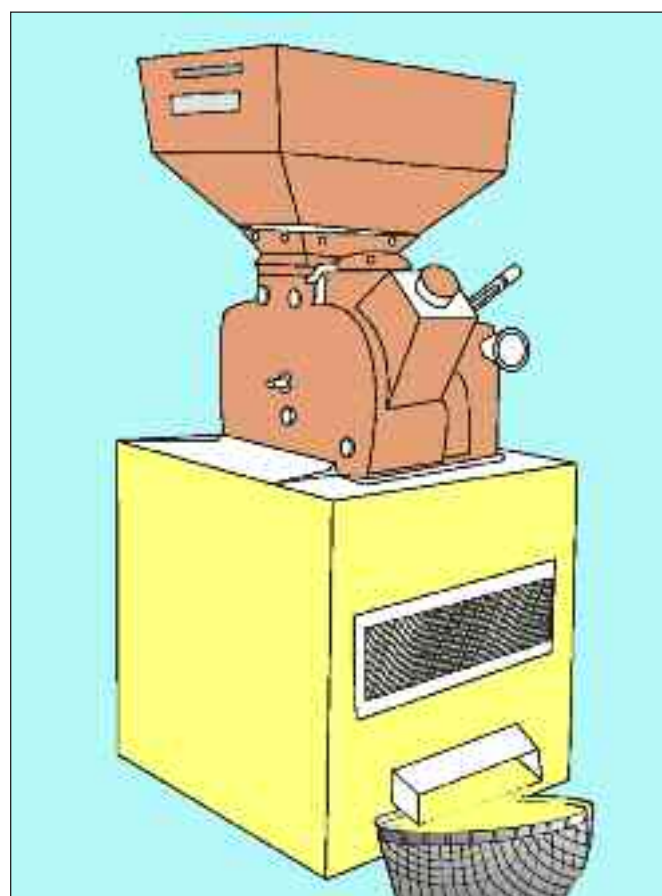

Figure 31c. A milling machine with a funnel-shaped feeding device.

CHECKPOINT 32

Position machines in a stable place when using them in farm fields.

WHY

Agricultural machines are used in field conditions, where the surface of the ground is not flat or stable. Your machines are safe and most productive when they are in a stable position. If they are not, they will wobble, and may move. You will have to spend a lot of effort fixing them frequently; you will lose efficiency, and will face increased accident risks.

In collaboration with your family and neighbouring farmers, you can fix machines safely by preparing a special place for operating them, or by applying fixing devices.

HOW

1. Check how your machines operate, and where they are sited. Identify the machines that need to be sited in places that are safer and more stable.
2. Assess your farm conditions, and find a safe place to site your machine. It should be even, solid and not slippery.
3. You may not be able to find a safe, stable place in the existing farm conditions. If so, build a safe place to site your machine. You might bring in soil or cement from outside to make the place safe for use of your machines.
4. Devise and apply fixing devices to stop machines moving. This measure is particularly important for machines with wheels.

WAYS TO PROMOTE COOPERATION

It is important to exchange experiences of ways to place a machine safely. You can learn from each other's improvement ideas. Many machines are heavy, and it is essential that farmers cooperate when building a safe place, and when moving and fixing machines. Villagers may also need to work together to improve the routes to their farms to carry machines safely.

SOME MORE HINTS

- Choose a convenient place to site your machine. It should be near your home, to reduce the distance to move the machine.
- Find a safe way to move machines to fields. Repair paths and other routes if necessary.
- Install wheels on your machine for easier transport; or you might design a special cart to carry the machine.
- Install a shelter to prevent damage to the machines from rain, snow or strong sunshine if you keep them outside, and also to protect the place where the machines are placed from erosion by rainwater or melted snow.

POINTS TO REMEMBER

Machines are most productive and safest when they are fixed in a safe place.



Figure 32a. Use wedges to fix machines with wheels, or use machines with caterpillar tracks.

Figure 32b. Prepare a special place to site a machine safely on the farm.



CHECKPOINT 33

Work with partners when using machines, and avoid working alone whenever possible.

WHY

Working alone with a machine is risky. You need someone who can stop the machine immediately if you are involved in an accident. You can also provide emergency assistance to your colleague when he or she is in trouble with the machine.

If you work together, your work can be more efficient. You and your partner can decide an effective work procedure. For instance, while you are operating a harvesting machine, your partner can collect, pack and move the products.

HOW

1. Assess your work plans for using your machines on the farm and in the fields. Avoid working alone whenever possible.
2. Plan your machine work together with your work partners and family members. Discuss how to share the tasks to make the work safer and more efficient.
3. Discuss how to ensure safety while using machines. Your partner should watch your machine operation, and provide advice on safety.
4. Let your work partners know how to stop machines in an emergency. You should also know how to stop their machines.
5. Develop emergency procedures to help your partner if he or she has a machine accident, and to take the victim to hospital.

WAYS TO PROMOTE COOPERATION

When using machines, work with partners whenever possible. Mutual help will be possible when you work with partners. Discuss with your partners how to work together and develop a realistic work schedule. Confirm the benefit by sharing tasks so that your work will be most productive.

SOME MORE HINTS

- Keep a safe distance away from your partner's machine when it is operating.
- You and your partners should establish safe work procedures to avoid an accident when more than two machines are being used simultaneously.
- Take regular breaks in order to avoid excessive fatigue. This break time is also useful for reviewing and discussing safer operating procedures.
- Review and discuss with your partners ways to develop safe and efficient work procedures.

POINTS TO REMEMBER

You will find safer and more efficient ways to use machines when you work with your partners.



Figure 33a. Work with your partners and help each other for safe operation.



Figure 33b. Keep yourself away from machines in operation.

CHECKPOINT 34

Make sure that machines are well maintained, and have no broken or faulty parts.

WHY

Machines are most productive and safe when they are in good condition. If your machine has broken or faulty parts and is not in good condition, you will have to pay special attention to these problems when operating it. You and your colleagues will have to face higher accident risks, and your work efficiency will be reduced.

Regular maintenance is needed to maintain the best condition of your machines. Allocate sufficient time for machine maintenance as part of your routine work. Time for machine maintenance is not time wasted, but a good investment. You will enjoy higher productivity and a stable income, and have no loss due to accidents.

HOW

1. When you purchase a new machine, check all its parts carefully, including guards.
2. Check your machine every day before starting operation. Ensure that there are no loose or broken parts in the machine. Once you have found a problem, repair it as soon as possible. Don't use the machine until the problem is fixed.
3. Make sure that all switches are off during maintenance work on your machine.
4. Make a checklist for your daily machine maintenance to check all essential points for safety. You can share the checklist with other farmers, or learn from their checklists.
5. Develop a long-term maintenance plan. For instance, you might check the machine thoroughly every weekend.
6. You should also ask an engineer to check your machine regularly after you have used it for a specified period.

WAYS TO PROMOTE COOPERATION

Learn effective maintenance techniques and plans from experienced farmers. If you share some machines with your partners, develop a joint maintenance plan. Keep maintenance records, share the information with all the farmers who use the machine, and let them know the condition of the machine.

SOME MORE HINTS

- Ensure you get after-sales service from machine suppliers. Ask for their advice and support when necessary.
- Don't purchase machines just because they are cheap. You may face extra costs later to fix problems. If an accident occurs, the cost can be high, and you could be injured and lose your income.

POINTS TO REMEMBER

Good machine maintenance helps farmers enjoy safety and high productivity.



Figure 34a. Check essential points every time before starting machine operation.



Figure 34b. Pay special attention to dangerous parts of the machine. Ensure that the machine is switched off during maintenance.



Figure 34c. Provide a stable work table of appropriate height for checking hand-held powered tools.

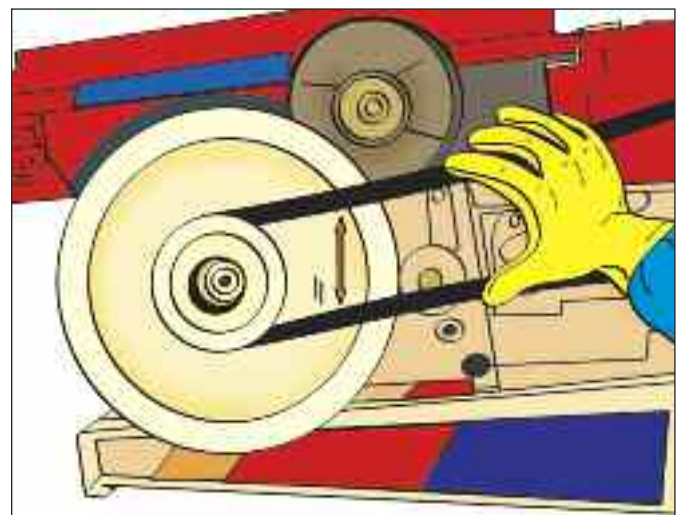

Figure 34d. Don't touch the moving parts of the machine when the guards are removed for maintenance work.

CHECKPOINT 35

Ensure that connectors for supplying electricity to equipment and lights are safe and secure.

WHY

Farmers use electricity for many purposes. Unfortunately, electrical accidents are increasing among farmers. Such accidents can occur if safety procedures for electrical equipment are ignored. The safe use of electricity is crucial for the happiness of families and communities.

Farmers need to use many kinds of machine, such as threshing machines, water pumps and electric sprayers, in field conditions, exposing them to humid and wet environments. In such an environment the risks from damaged or faulty electrical agro-machines are high. Proper maintenance and control of the connectors between electrical cables and machines are very important to prevent electrocution or machine breakdown.

Well-protected electrical connections will ensure the safety both of the machine operators and of other farmers, families or visitors passing by the farm. Appropriate insulation of all electrical cables connected to machines, and their proper maintenance, can prevent electrical accidents and machinery damage.

HOW

1. Always use cords or outlets equipped with earth-fault circuit-breakers. Don't leave appliances plugged in where they might come into contact with water.
2. Check all electrical wire junctions. Wrap them carefully with electrical adhesive tape. Never leave any wire junctions uncovered. Ensure prompt replacement of the electrical adhesive tape if it becomes loose or is worn out.
3. If any electrical junctions are damaged or broken, replace them immediately with safe new ones.
4. Protect all circuits with circuit breakers or fuses. The main power switches and breaker boxes should be clearly marked.

WAYS TO PROMOTE COOPERATION

Electrical safety needs special skills and experience. There must be qualified specialists in your village who are knowledgeable in electrical safety. Organize a brief on-site training session on electrical safety. Share experiences among farmers, and develop joint maintenance plans for electrical safety in your village.

SOME MORE HINTS

- Use approved electrical plugs and circuits. Cheap versions may cause short circuits, resulting in accidents and machine breakdown.
- Keep all plugs and cables in a proper storage place after use.
- All electrical equipment should be correctly earthed. Use an independent earthed rod to connect the earth wires from machines.

POINTS TO REMEMBER

Well-protected electrical wires that are maintained properly can help prevent accidents and machine damage.

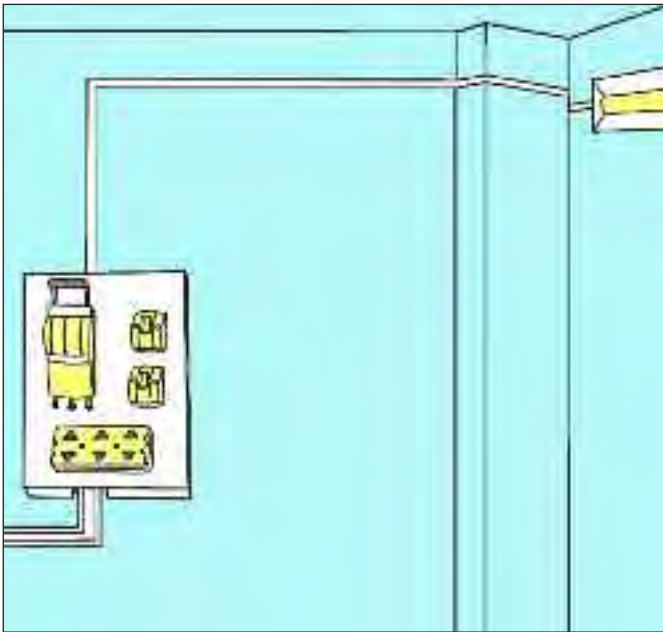

Figure 35a. The electrical wires connected to the switchboard are properly sheathed.

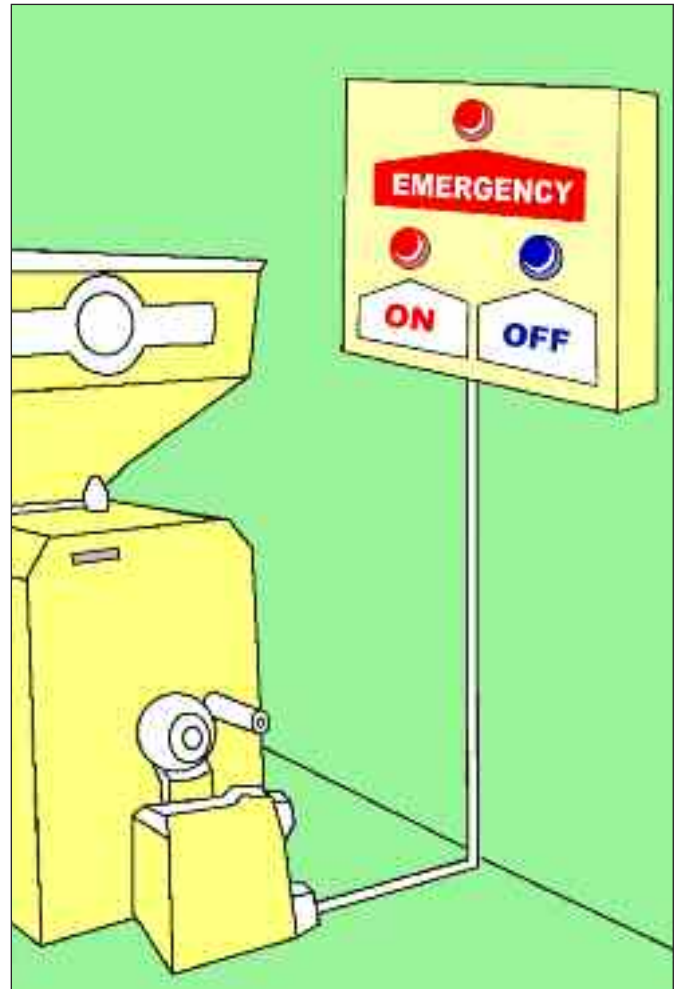

Figure 35b. Electrical cables connected to the machine are well protected and clearly labelled.

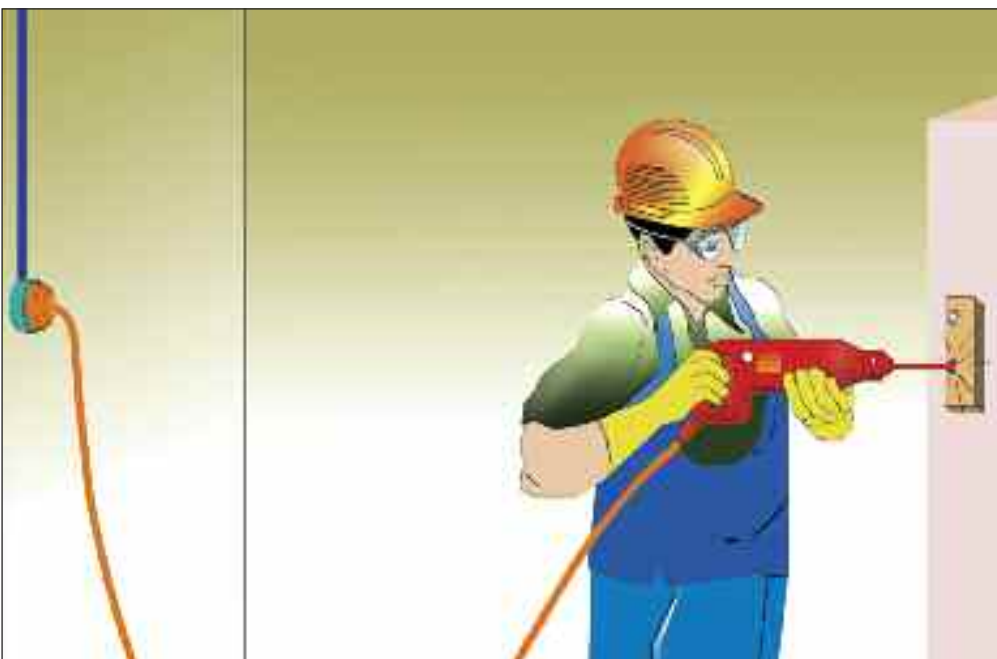

Figure 35c. Make sure that the plug and cable of your portable tool are kept out of other people's way and don't come into contact with water.

CHECKPOINT 36

Use hand-held powered tools that have stable grips in easy-to-handle positions.

WHY

Hand-held powered tools help farmers to greatly reduce their manual workload. These tools are handy and powerful, for instance when cutting grass or sawing wood. Farmers can carry the tools and apply them wherever they need.

Attaching stable handgrips to such tools increases their usability and safety. Tools with stable handgrips are much easier to handle, and result in higher efficiency and safety.

HOW

1. Replace your non-powered hand tools with powered ones when appropriate and possible.
2. Check all the powered tools that you use. If they don't have stable grips in easy-to-handle positions, consult with experienced farmers or tool suppliers, and consider attaching stable grips if feasible.
3. Design such a handgrip to be easy to handle for safe and efficient operation. Test several options while developing it.
4. Ensure that grips are stable and not loose. Powered tools are very dangerous if handgrips are unstable while the tool is being operated.

WAYS TO PROMOTE COOPERATION

Designing and attaching stable grips to powered tools needs experience. Find existing good examples from your neighbouring farmers, and learn from these examples to improve your grips and how to attach them to your tools.

SOME MORE HINTS

- When possible, use both hands for safe use of powered tools. The grips should be designed to be used by both hands.

- Consult machine retailers and tool suppliers. They usually have good ideas and options.
- Check and maintain your powered tools regularly, including their handgrips.

POINTS TO REMEMBER

Stable handgrips will increase safety and productivity when farmers use powered hand tools.

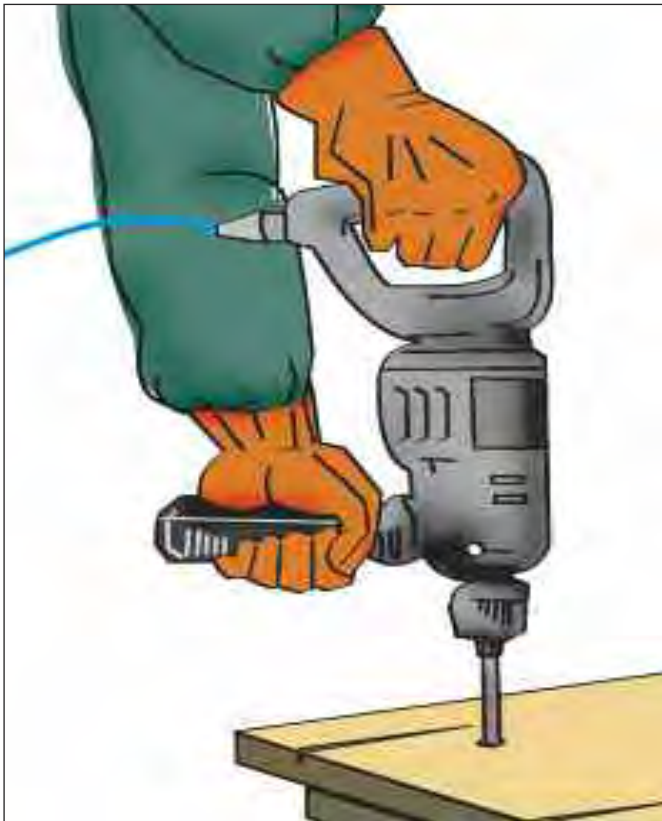

Figure 36a. Use hand-held powered tools that have strong, stable handgrips.



Figure 36b. Hand-held powered tools reduce farmers' workloads. Stable handgrips are essential for safe, productive operation.

CHECKPOINT 37

Use walk-behind machines that are easy to operate, and which stop automatically when the control is released.

WHY

Many farmers use walk-behind machines for cultivating soil or harvesting crops. These machines are well suited to agricultural working environments, and can provide effective solutions to traditional problems such as sustained forward bending or handling heavy agricultural products. But these machines can cause accidents when used in the field.

You need to know the risks and hazards of these machines, and take appropriate measures to reduce them. It is safe to select and use walk-behind machines that stop automatically when the control is released.

HOW

1. Identify those of your tasks that depend heavily on manual work. These might include cultivating, planting, removing grasses or harvesting.
2. Consider whether practical walk-behind machines can reduce your physical workload and improve your work posture, making it less strenuous.
3. Consult your neighbouring farmers who are using such machines, or contact the suppliers for more information. Select a safe machine that is easy to operate, and which stops automatically when the control is released.
4. Practise use of the walk-behind machine that you have purchased, to ensure safe and efficient operation.
5. Assess the safety risks of walk-behind machines, such as falling or slipping, and take measures to reduce them.

WAYS TO PROMOTE COOPERATION

Learn from experienced farmers to ensure the safe and productive operation of walk-behind machines. You might purchase and use a machine together with other farmers. If so, set up a joint maintenance plan, and routinely share the information on the machine's condition.

SOME MORE HINTS

- Walk-behind machines are helpful for many tasks. Start with one, to get familiar with this type of machine, and then you will know better whether you need other machines for your various work tasks. Have a good maintenance plan.
- Improve your farms and fields for safe operation: for example, remove stones, and ensure there are no holes and no sudden height differences.
- Instruct your family members not to come close to the machine when it is in operation.
- Walk-behind machines are especially useful for smaller farms and rice fields. If you work on a larger farm or in large rice fields, consider other types of machine.

POINTS TO REMEMBER

Walk-behind machines greatly reduce farmers' manual workloads when used properly and safely.



Figure 37a. Easy-to-operate walk-behind machines reduce farmers' workloads.



Figure 37b. Select a machine that stops automatically when the control is released.



Figure 37c. When the machine you use has no automatic stop, try other ways of improving the safe operation.

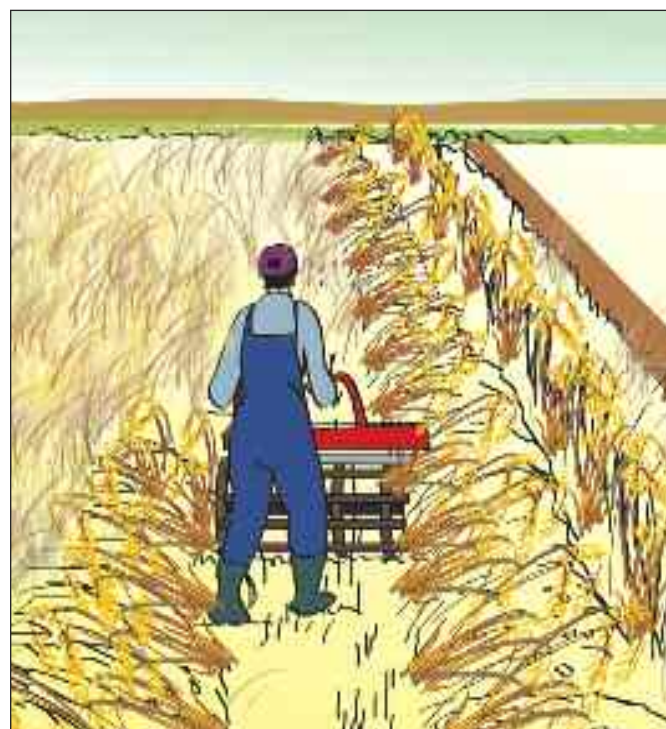

Figure 37d. For safe machine operation, ensure there are no stones or holes in the ground.

CHECKPOINT 38

Ensure that hoists and cranes are operated in accordance with the specified load limits and safety precautions.

WHY

Farmers use hoists and cranes to move heavy loads, such as machines, bulk products and other materials. These machines are very powerful, and can cause serious accidents if they are not used properly.

Adhere to the load limits of the hoists and cranes that you use. Overloading is the main cause of serious accidents. The machines might collapse and injure many people. Make sure you understand all the safety precautions for the machine and ensure that they are complied with.

HOW

1. You need the correct training and an appropriate licence to operate certain types of hoist and crane. Don't operate them without the licence. Advise your colleagues not to operate them without the training and licence.
2. Check all the safety precautions before operating hoists and cranes. Use well-maintained machines.
3. Place hoists and cranes on stable ground. If such machines are unstable, they can fall down and cause accidents.
4. Ensure that the load limits of the hoists and cranes that you use are not exceeded. Measure the weights of materials that your machines are to lift.
5. Use strong cables and safe fixing devices and methods when connecting the load to the machine. Falling objects are another major cause of serious accidents when using hoists and cranes.

WAYS TO PROMOTE COOPERATION

Ensuring safe operation of hoists and cranes needs training and long experience. Learn from experienced and licensed farmers. If you have no training, ask them to operate the machines for you. When you see someone without a licence operating hoists and cranes, stop them, and advise them about proper training.

SOME MORE HINTS

- Don't use hoists or cranes to carry people.
- Mark out danger zones when hoists and cranes are in operation. Ensure that nobody, including your family members, enters the zones.

POINTS TO REMEMBER

Hoists and cranes are powerful, and should be used properly by ensuring adherence to the load limits and safety precautions.



Figure 38a. Fix the load safely when it is being lifted by a hoist or a crane.

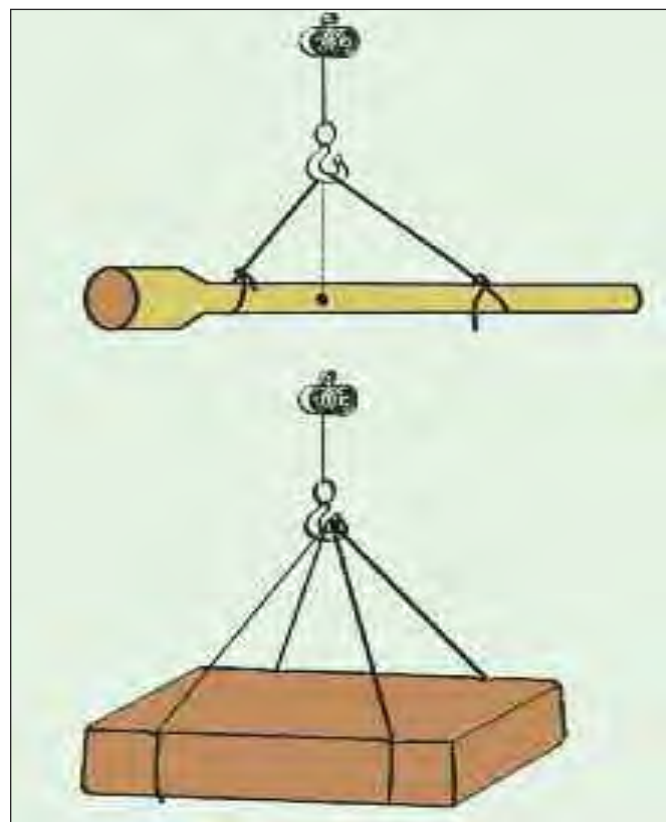

Figure 38b. Consider the balance of the load to avoid falling accidents.

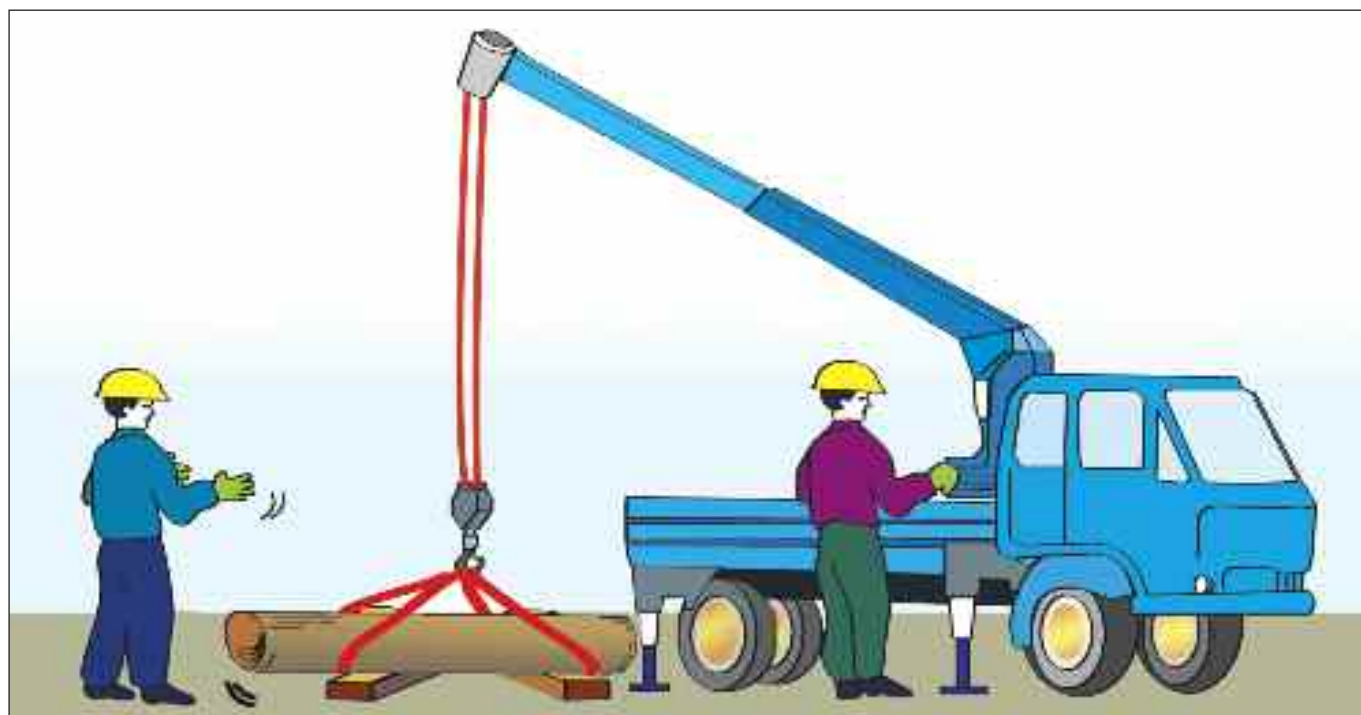

Figure 38c. Place the crane on flat, stable ground.

CHECKPOINT 39

Protect machine controls, to prevent accidental activation.

WHY

Machines can be started accidentally, since operating control buttons and switches are often uncovered and so someone may push them unintentionally. Accidental activation of machines is dangerous, and may seriously injure or even kill farmers or their family members who are close to the machines.

You can reduce this accident risk by protecting operating controls and switches. There are many simple ways to use transparent materials to cover controls and switches in order to ensure safer operation.

HOW

1. Check the controls and switches of all your machines, and ensure that they are well protected against accidental activation.
2. If they are not, then you need to improve them. Find existing good examples from machines that your neighbouring farmers are using, and get ideas for safe design.
3. Use transparent materials to cover controls and switches, to keep them visible.
4. There are two practical ways to protect controls. The first is to cover a group of controls with a single transparent box, and make holes for each of the controls. The second is to protect each control button separately.
5. Check carefully that machines are still easy to start and stop after installing new protection measures. Ensure that these measures don't prevent safe, smooth machine operation.

WAYS TO PROMOTE COOPERATION

Find existing good examples of protected machine controls from other farmers. Learn from their experience on how they made the protection measure and improved machine safety. When you install the new control protection, you should also show this good idea to other farmers.

SOME MORE HINTS

- Make emergency stop switches clearly visible by using outstanding colour and shape, and make sure that anyone can stop the machine in an emergency.
- Check the protected controls regularly. Transparent materials may become dirty with continued use, and the controls might be difficult to see. This could be dangerous. Replace the protection as soon as possible.
- Use strong covering materials to protect controls. Don't use glass materials that are easy to break, and can cause cuts and other injuries.

POINTS TO REMEMBER

Simple protection measures can prevent accidental activation of a machine and increase safety.

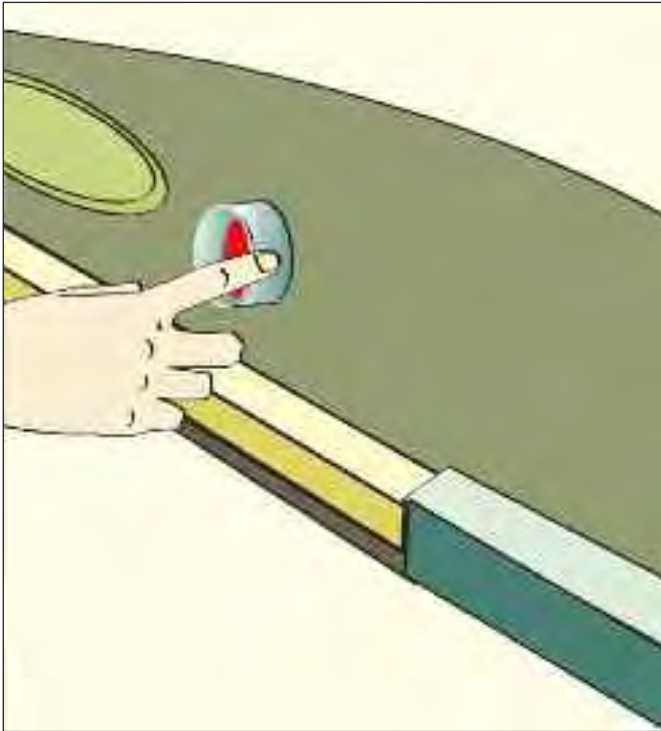

Figure 39a. Protect machine controls to prevent accidental activation.

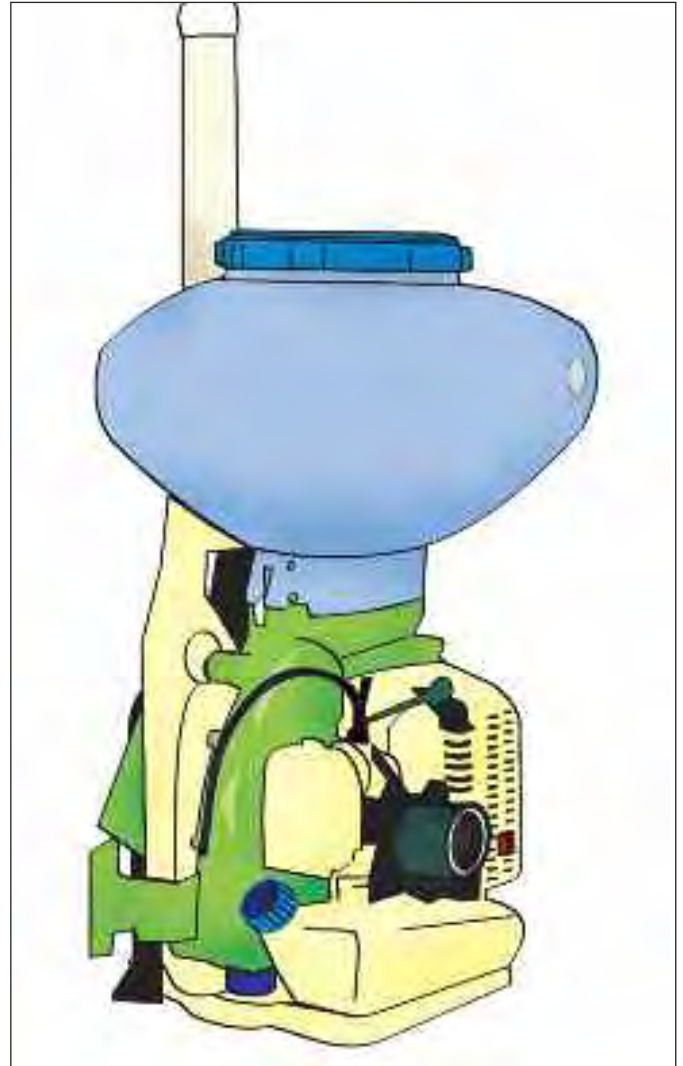

Figure 39b. Controls should be clearly visible, even after installing protection.

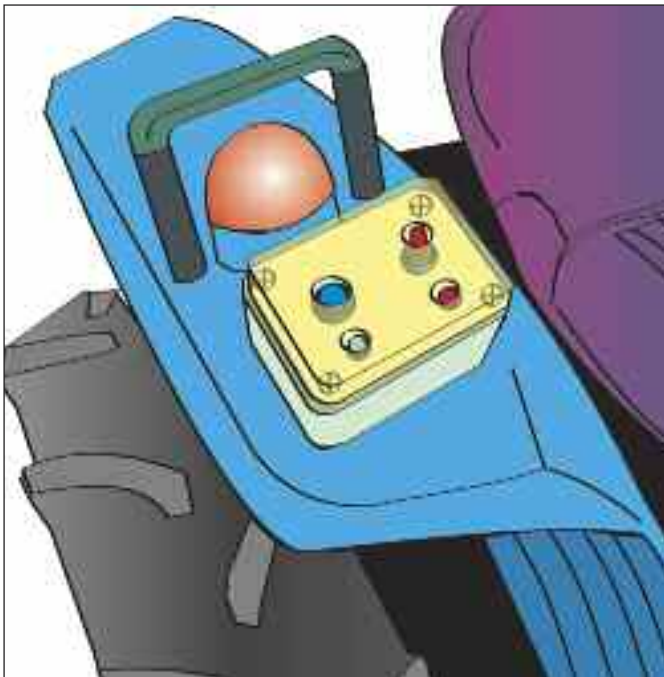

Figure 39c. A group of switches can be protected together.

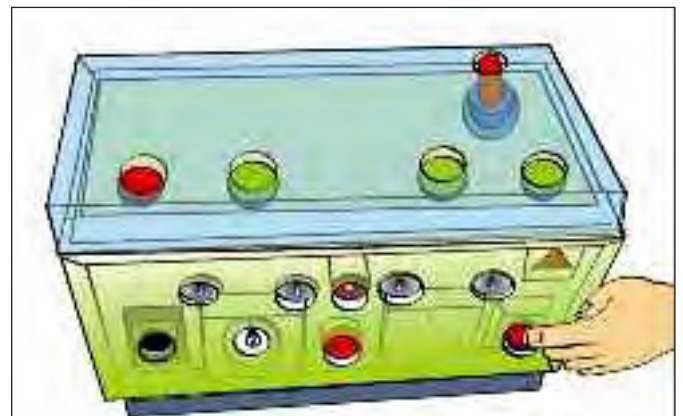

Figure 39d. Use materials that are transparent but strong to ensure safe, easy operation of controls.

CHECKPOINT 40

Make emergency switches easy to locate and operate.

WHY

For any machine, the emergency stop switch must be clearly visible. Accidents and mistakes can happen unexpectedly. Immediate action is needed if someone gets caught in dangerous machine parts. Emergency controls need to be well designed so that everybody, including visitors and outsiders, can see them easily and understand how they work.

Place a label on each of the switches and controls to avoid misunderstanding and mistakes. The labels should be clearly visible, and use simple, easy-to-understand words. Of course, they must be written in the local language.

It is wise to use different colours and shapes for different controls and switches. Similar colours and shapes may cause misunderstanding, even by farmers using the machine every day. The result of such misunderstanding could be a serious accident.

HOW

1. Place the emergency controls or switches of machines within easy reach of users. Separate them from other switches.
2. When emergency controls or switches are placed in the same area as other control buttons, make them clearly visible: for example, use a red colour, a larger size and an unusual shape.
3. Use large, clear characters for the labels of controls and switches. Replace unclear labels, or those written in a foreign language, with labels clearly written in the local language.

WAYS TO PROMOTE COOPERATION

You can find emergency controls and switches on the machines used at home and in the farm. Check whether they are clearly visible, and easy to understand.

Encourage your family and farmer friends to attach clear labels to controls and switches. They must be written in the local language. Together, design clearly visible switches and controls. Share good designs with your neighbours.

SOME MORE HINTS

- Label clearly which operation is controlled. If you use symbols for switches, they must be clear and easy to understand.
- The direction of controls and switches must be easy to understand using common sense and local custom. For example, in many countries and cultures, ON is up, and OFF is down.

POINTS TO REMEMBER

Controls and switches that are clearly visible and easy to understand will help save you, your family and your friends in an emergency.



Figure 40a. Make the emergency control of the machine clearly visible, and place it within easy reach of the user.

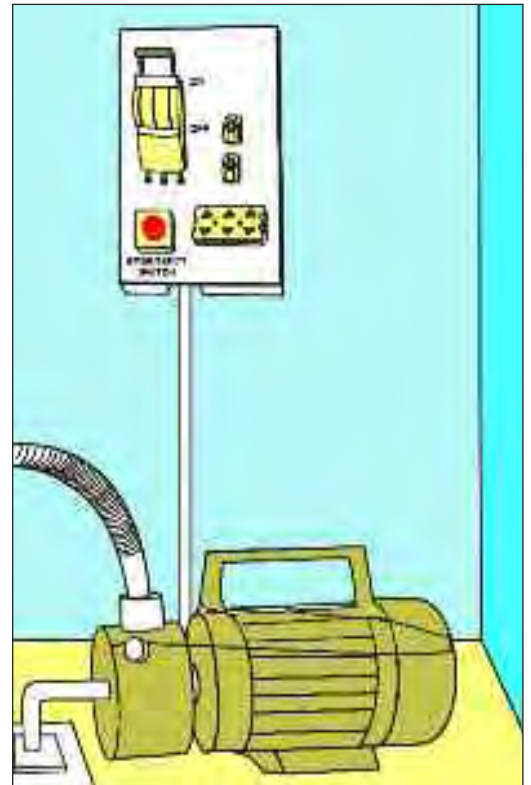

Figure 40b. Emergency controls for a pump, attached to a visible board. Keep such controls separate from other switches, and label them in the local language.

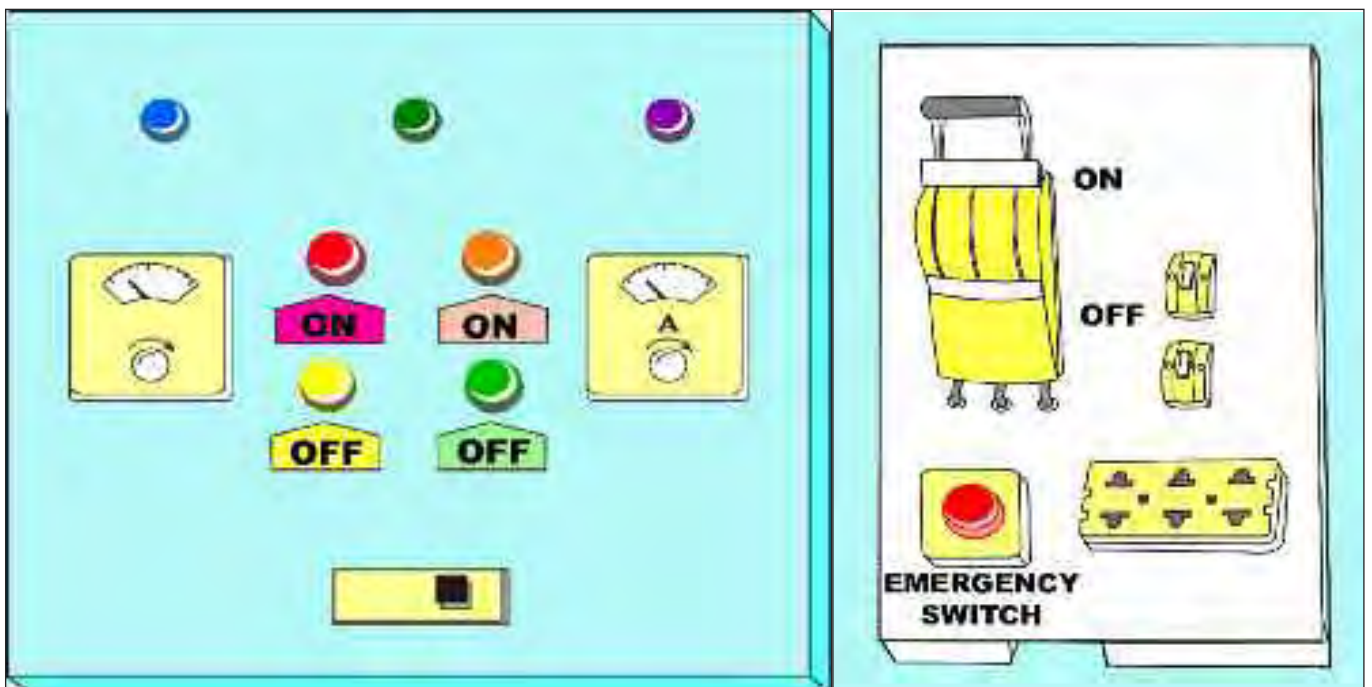

Figure 40c. An electricity board with visible controls, switches and displays; all are clearly marked in the local language.

Agricultural vehicles

Agricultural vehicles are increasingly used in both industrially developed and developing countries. Safety and health in operating these vehicles are closely related to the ergonomics of their design.

This chapter presents practical ideas in improving safety and health conditions in agricultural vehicle operations. In addition to basic machine safety precautions, good, safe cabin design, traffic safety and the prevention of rollover accidents require particular attention.

CHECKPOINT 41

Purchase and use agricultural vehicles that are appropriately designed for agricultural work, with necessary safety precautions.

WHY

Agricultural vehicles are the main causes of serious and fatal accidents on farms. By checking the design and operating procedures of the vehicles before purchasing them, you can greatly reduce the risk of such accidents.

It is particularly important to protect drivers from rollover accidents, falling off or being caught in towed machinery, as these are major risks. It is essential to know whether the vehicles you intend to purchase can be safely operated in actual field conditions.

You need to study not only the machine controls, but also the various risks in different field conditions, including those related to attachments, servicing and climatic conditions. By checking these aspects, you can select vehicles suited to your local situation.

HOW

1. Check the vehicle and its operation manuals with people who are knowledgeable about the safe operation of agricultural machines. Also check the work procedures in various field conditions, including those on slopes.
2. Also check the safety aspects of operating implements and other attachments to the vehicles.
3. Carefully examine the protection against rollover accidents. You need to take into account the stability of the vehicle on slopes and in different manoeuvres.
4. Discuss with others the potential injury risks from moving and protruding parts, and from gases, noise and hot surfaces.
5. Check the protection against the potential risks associated with servicing in field conditions.

WAYS TO PROMOTE COOPERATION

Always discuss the safety of vehicles to be purchased with your colleagues, including those more experienced in vehicle operations. Compare the options, following useful advice.

SOME MORE HINTS

- Examine the causes of serious accidents involving agricultural vehicles. Pay particular attention to rollover and falling risks. Ensure that the driving cab is protected.
- To ensure safety in the use of vehicles, it is often necessary to make changes to access roads, operation sites and vehicle depots.

POINTS TO REMEMBER

Consult with your colleagues and other knowledgeable persons about the safety of vehicles before you purchase them. Take into account rollover and other serious safety risks and health aspects.



Figure 41a. Familiarize yourself with the operation manual and safe operating procedures of the agricultural vehicle you are purchasing. Get advice from other people, including those who are knowledgeable about the safety aspects of agricultural machinery.



Figure 41b. Check the work procedures and related safety aspects of the implements to be attached to the agricultural vehicle.

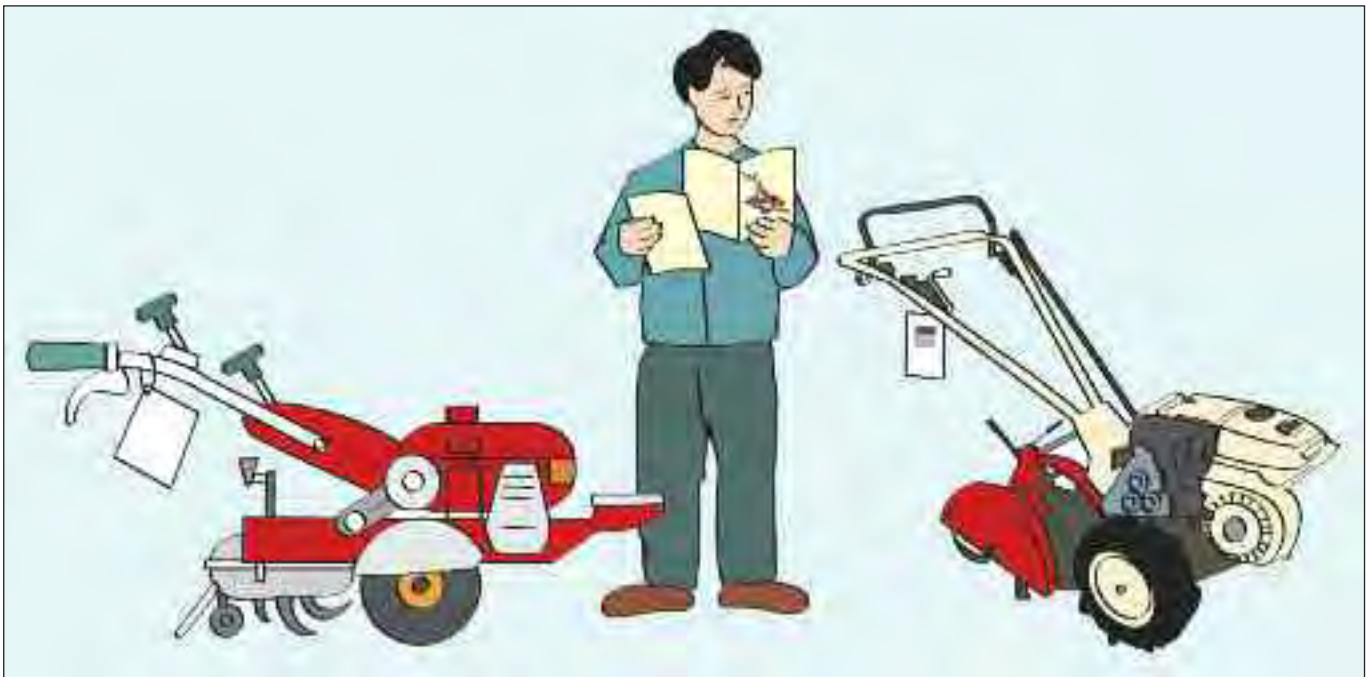

Figure 41c. Compare the vehicles you plan to purchase with other types of agricultural machine in terms of work performance and safety. This can help you examine the need for the vehicles more carefully.

CHECKPOINT 42

Provide a sufficient number of traffic signs, mirrors, warning signs and reflectors.

WHY

Agricultural vehicles are operated on both public roads and field routes. Additional traffic signs put along the field routes and at junctions with public roads help increase safety of the vehicles.

Mirrors are important for agricultural vehicles to ensure visibility of people and obstacles, particularly in field conditions.

Agricultural vehicles have shapes that are different from cars. Reflectors placed on the corners of vehicles and attachments are important, particularly on public roads.

HOW

1. Install traffic signs on the routes used by agricultural vehicles. Put up mirrors and reflectors at sharp turns, and where roads are narrow or uneven.
2. In agricultural areas, traffic accidents could involve both agricultural vehicles and agricultural animals. Put up warning signs to ensure safe traffic at junctions with public roads, and advising caution where animals may cross the road.
3. Carefully protect the vehicle's mirrors and repair damaged ones promptly to ensure a good visibility for the drivers.
4. Safety reflectors are particularly important for vehicles in rural areas, as there are no streetlights. Keep the vehicle safety reflectors clean and free from dirt, and replace faulty ones as soon as they are found.

WAYS TO PROMOTE COOPERATION

Discuss with other farmers, and with your neighbours, installing or improving the traffic signs, warning signs, mirrors and reflectors on the roads you share. Get help from your community and local government if you can't solve the problem by yourself, or with your neighbours or other farmers.

SOME MORE HINTS

- Always keep a traffic safety triangle in your agricultural vehicle, and place it properly in a breakdown situation. Wear safety clothing when you are out of your vehicle when it is dark.
- Ensure that faulty lights are replaced as soon as possible; good lighting is essential for drivers to see properly not only the road conditions, but also the traffic warning signs and reflectors.

POINTS TO REMEMBER

Proper traffic safety signs, warning signs, mirrors and reflectors are essential for the prevention of accidents and injuries caused by agricultural vehicles.

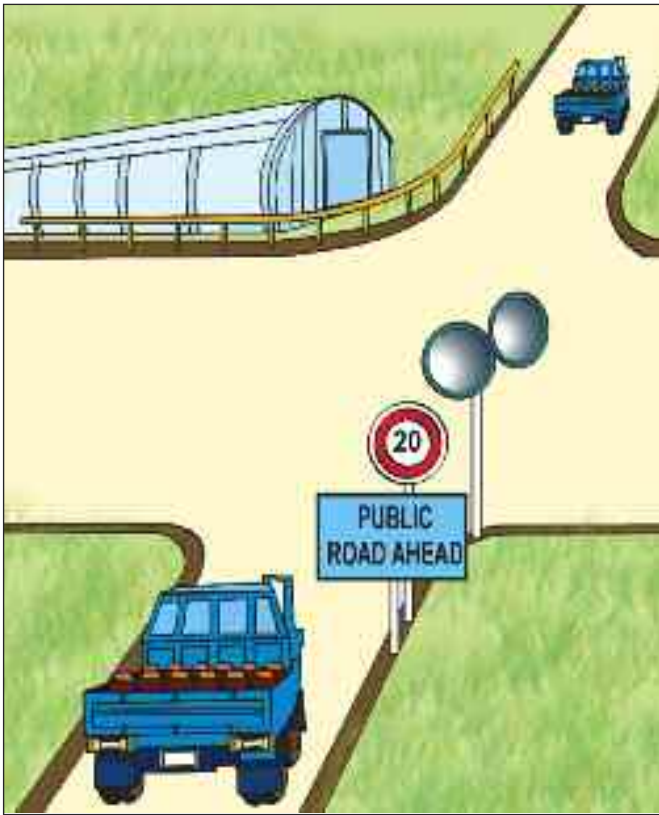

Figure 42a. Put up warning signs and mirrors to ensure safe traffic at junctions with public roads.



Figure 42b. Side mirrors on both sides of the vehicle, together with reflectors and additional lights.

Figure 42c. Reflectors on attachments to agricultural vehicles are essential for safety.

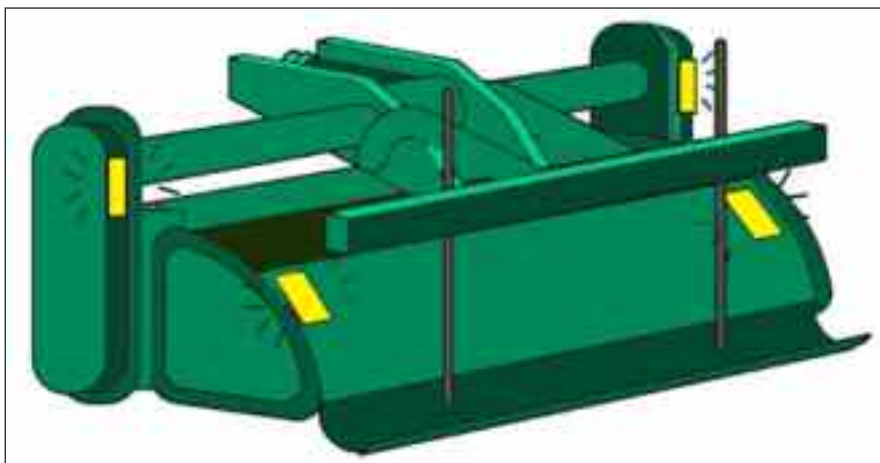

Figure 42d. Reflective stickers on working clothes and helmets.



CHECKPOINT 43

Ensure safe operation of agricultural vehicles by obtaining sufficient training, and by providing easy-to-read operation manuals.

WHY

There are several precautions that need to be carefully observed when operating agricultural vehicles, from preparing the vehicle to operating it on the roads and in the field, as well as in dealing with attachments, maintenance and parking. Systematic training is essential.

During periodic inspection and servicing of vehicles, the instructions in the operation manuals must be followed. This is achieved through guided training.

Once a vehicle is delivered, it is the operator who must assume responsibility for avoiding accidents, fires and health hazards. Easy-to-read operation manuals are essential.

HOW

1. Before operating any agricultural vehicle, anyone who is to use it should attend a training course on its safe operation.
2. Use brochures and videos to discuss, with neighbours and family members, the safety precautions required in operating and servicing agricultural vehicles.
3. For new types of vehicle, thoroughly learn safety measures that are different from older types, and any additional precautions.
4. Before starting daily work using the vehicles, have a brief meeting involving all people taking part in the work about work procedures and associated dangers.
5. Follow the safety instructions in the user's guide, and ask other experienced people or the vehicle supplier if you have safety questions.

WAYS TO PROMOTE COOPERATION

Have brief meetings with neighbours and family members about the safety precautions for preventing vehicle accidents. Consult nearby agricultural vehicle centres about questions raised during the meetings.

SOME MORE HINTS

- Exchange information with your neighbours and local organizations about safe vehicle operation and accidents.
- Learn about local improvements in securing safety measures for vehicle operation through retraining courses and local meetings of farmers.

POINTS TO REMEMBER

Accidents and health hazards associated with agricultural vehicles can be avoided by a careful, safe operator. Understand thoroughly the necessary precautions set out in the operation manuals.

Figure 43a. Provide sufficient training in the safe operation of agricultural vehicles, including pre-operation checks, safe work procedures in field conditions, and servicing.

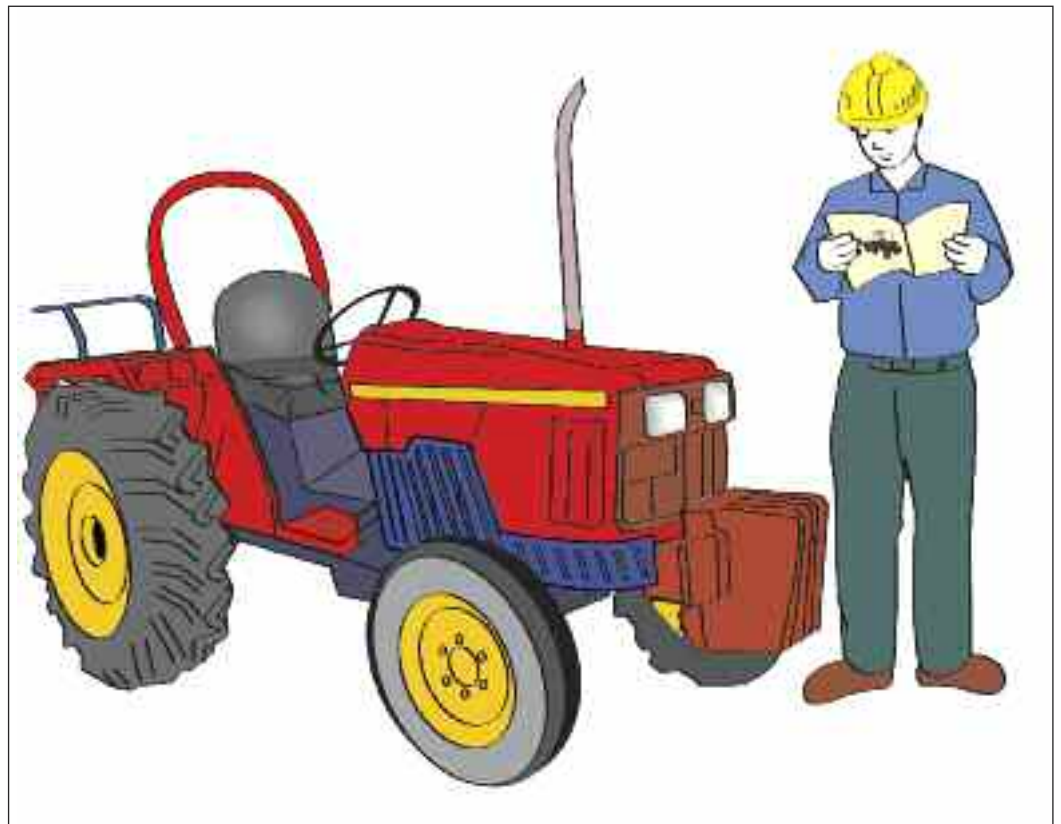

Figure 43b. Easy-to-read operation manuals and servicing instructions should be kept in the cabin and be available within easy reach of the driver.



Figure 43c. Training in the safe operation of vehicles and other types of agricultural machine should be provided in a consistent manner that meets local needs. Easy-to-read manuals must always be available for the operator.

CHECKPOINT 44

Make sure there are adequate routes and slopes for moving vehicles.

WHY

Agricultural vehicles are used almost daily in busy farming seasons, and frequently also in other seasons. Safe routes secured for movement of the vehicles can greatly reduce accidents.

Sudden height differences in moving the vehicles inside and around their depots often cause difficulties that may lead to accidents. It is important to provide sturdy ramps and eliminate unnecessary height differences.

Slopes on routes and access roads to farming areas must be carefully arranged to avoid difficulties in vehicle operations and potential accidents. This is achieved by the collaborative efforts of people.

HOW

1. Check the safety of all routes along which agricultural vehicles move from their depots to the fields. Discuss the arrangements required for smooth movement of the vehicles.
2. Eliminate or reduce unnecessary height differences on vehicle routes, and ensure that the routes are free from obstacles. If necessary, provide proper ramps of sufficient width. Also pay attention to bridges over ditches and canals.
3. Maintain route surfaces properly, particularly after rain and snow, for safe movement of vehicles.
4. Learn from good examples of safe roads and access routes for agricultural vehicles in the vicinity. Improve your roads and routes by applying similar ideas and methods.

WAYS TO PROMOTE COOPERATION

Organize a special meeting of farmers and local organizations to discuss the need for safe roads and access routes for agricultural vehicles. Improve the roads and routes through the collaboration of people.

SOME MORE HINTS

- Look for materials that are suitable for the surfaces of roads and access routes for vehicles. Consider ways to avoid difficulties and damage in rainy seasons.
- Minor low-cost changes in access routes, their surfaces, ramps and slopes are often very useful. Try useful options through discussion with your neighbours and family members.

POINTS TO REMEMBER

Safe, smooth routes for agricultural vehicles help save time and effort, and reduce accidents. The best way to improve routes is to discuss the necessary changes with neighbours and family members.



Figure 44a. Ensure that routes are wide enough for agricultural vehicles, and eliminate sudden height differences wherever possible.

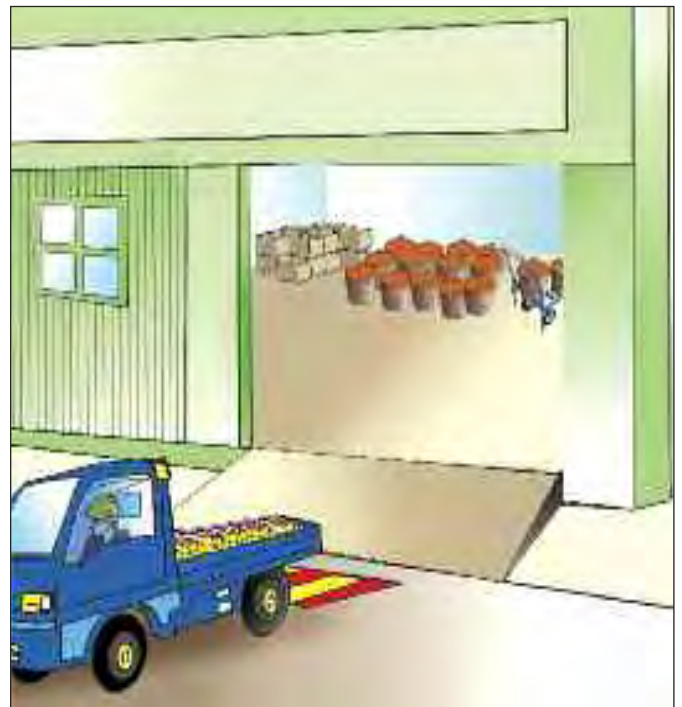

Figure 44b. Provide ramps of sufficient width at the entrances to a vehicle depot if there are height differences between the floor of the depot and the ground level outside.



Figure 44c. Provide stable platforms to form a route for vehicles to get on and off a boat.

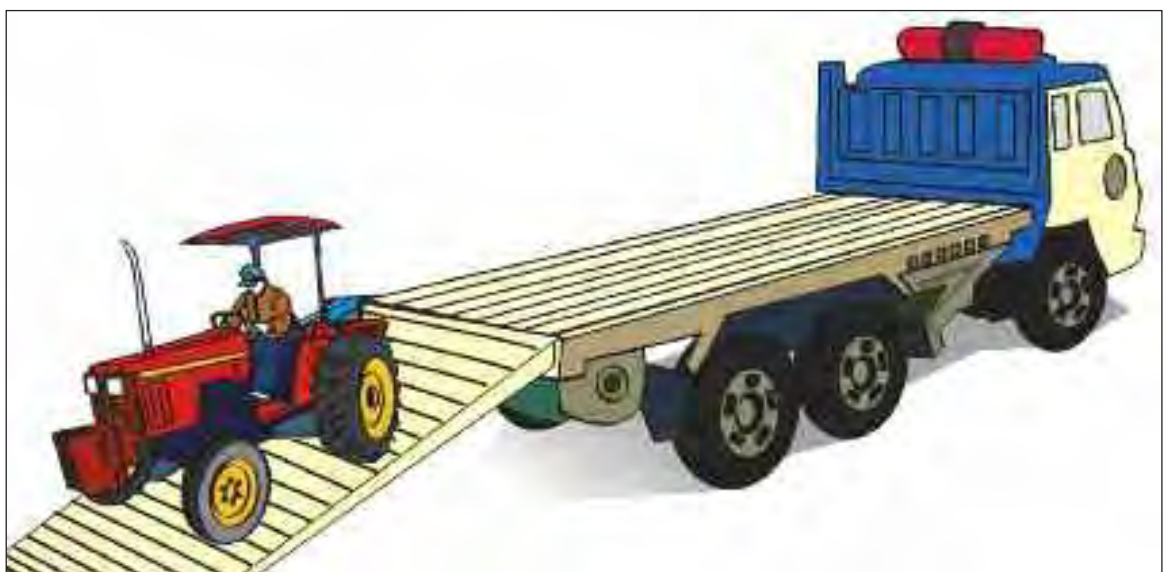

Figure 44d. When a vehicle is carried on a truck or a boat, make arrangements to ensure the safe, smooth loading and unloading of the vehicle.

CHECKPOINT 45

Increase the safety and comfort of driving cabins and seats.

WHY

Agricultural vehicles are used in a large variety of field conditions. Good design of driving cabins is very important, to ensure the safety both of drivers and of people in the vicinity. Attention to cabin safety is a good starting point for increasing safety in field conditions.

Accidents involving cabins often have serious consequences. Measures are needed not only to prevention but also to reduce the severity of such accidents. Typically, measures against overturning of vehicles can save the lives of farmers driving in dangerous situations.

Comfort in the driving cabin enhances the safety of vehicles. Examples are protection from heat or cold, reduction in noise and vibration, good seat belts and good visibility for the seated driver.

HOW

1. Make sure that the driving cabin has a sturdy structure that can prevent injury to the driver if the vehicle overturns.
2. Examine the need to protect the driver from the heat of the sun, and from heavy rain. For lengthy operation in excessive heat or cold, a totally enclosed, air-conditioned cabin like that of an automobile may be necessary.
3. Ensure easy access to the driver's seat. Sturdy steps at appropriate height and grip handles may be helpful.
4. Make sure that seat belts don't cause any discomfort so as to ensure they are fastened in a consistent manner.
5. Examine the comfort of the driver, for example in terms of noise and vibration, and visibility from the driver's seat in different directions.

WAYS TO PROMOTE COOPERATION

Learn from improvements made to the cabins of other vehicles. Discuss low-cost ways in which cabin conditions could be improved.

SOME MORE HINTS

- Put labels on important controls and displays to help inexperienced drivers to operate the vehicle safely in field conditions.
- Provide a place to put a bottle of drinking water within easy reach from the seated position.
- Ensure good visibility from the seated position by considering drivers of different sizes.

POINTS TO REMEMBER

Good cabin design is important for the safety and comfort of the driver of an agricultural vehicle. Consider potential extreme conditions, such as overturning, bad weather and an inexperienced driver.



Figure 45a. The driving cabin must be protected from the dangers resulting from bad weather, and from falling or overturning accidents. A sturdy structure is essential.

Figure 45b. Easy access to the driving seat is also important, as are measures to reduce noise and vibration, to increase seat comfort and to avoid mistakes in operation.

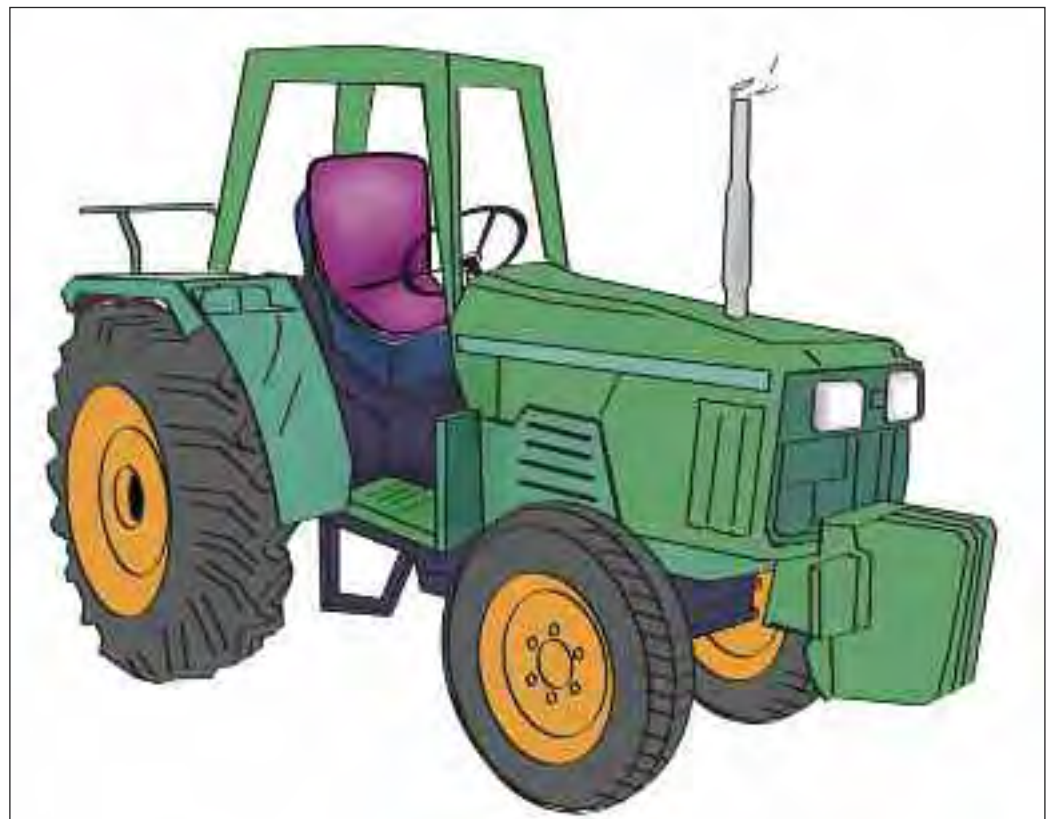

CHECKPOINT 46

Place loads properly on a vehicle so that they are carried safely.

WHY

Various kinds of materials and agricultural products are carried by agricultural vehicles. Tools and machines are also often carried. Proper loading and unloading procedures can reduce accidents and damage during transport.

Arrangements for securing the loads carried are important to preventing their falling or collapsing during transport. Simple arrangements, such as tying packages with ropes, can prevent such incidents.

Equipment for loading materials or products, or for lifting or lowering heavy items, can help in handling them properly for their safe transport.

HOW

1. Make loads compact and easy to carry as far as possible before loading them onto the vehicle for transport. Properly prepared packages, bundles and containers of appropriate sizes are useful.
2. Tie the packages and other types of load properly to the vehicle with ropes. Ropes supplied specifically for transporting vehicle loads must be used. Get training about tying and fixing the loads placed on the load-carrying platforms. Proper tying techniques must be used.
3. Make special arrangements for tying specific containers, tools or machines carried on the vehicle. This is very helpful for preventing dangerous movements of loads of irregular shapes during transport. If appropriate, cover the loads entirely and tie them over the cover.
4. Equipment for loading and unloading heavy items is useful for preventing injuries during their handling.

WAYS TO PROMOTE COOPERATION

Transport of agricultural products and materials is usually done together by a number of people. In a brief meeting of these people, discuss smooth ways of handling such loads.

SOME MORE HINTS

- Make arrangements for guarding small packages or heavy items during transport, for example by containers or plates. This can prevent damage and falling.
- Use ropes or cords for tying loads during transport. Carry proper ropes and rubber cords at all times so that they are available when the need for tying loads arises.

POINTS TO REMEMBER

The loads carried by agricultural vehicles may be of different shapes and sizes, and the vehicles have to run along bumpy surfaces. Special care and training are necessary for tying loads properly.



Figure 46a. Put agricultural products in appropriate containers, pile them neatly on the vehicle platform and tie them properly.



Figure 46b. Covers for materials or products carried are useful for preventing damage and falling.



Figure 46c. Use proper rubber cords and special ropes for tying containers or machines of different shapes securely on the vehicle. Make sure that loads don't move during transport along bumpy routes.

CHECKPOINT 47

Make sure that vehicles are not thrown sideways or overturned while at work.

WHY

The most serious accidents in agriculture generally occur when an agricultural vehicle such as a tractor rolls sideways, or is overturned by a back-flip. Fitting the vehicle with a rollover protective structure or a sturdy enclosed cab is an effective way to prevent serious injuries.

The danger of a tractor rollover is greatly increased on hills and sloping ground. Minimize the danger by avoiding, as much as possible, operating on steep slopes.

Rollover accidents can be further prevented by following safe procedures for operating vehicles on slopes.

HOW

1. Ensure that the tractor or vehicle used in fields has been fitted with a rollover protective structure or enclosed cab that meets recognized standards.
2. Refer to the operation manuals about reducing the risk of rollover incidents. Fit attachments strictly in accordance with the operation manuals. Use a seat belt on a vehicle. Minimize the chances of operating vehicles on steep slopes, or crossing slopes.
3. Drive at speeds that are low enough to retain control over unexpected events.
4. Lower the centre of gravity by fitting heavy attachments in a low position on the vehicle. This can reduce rollover risks.
5. Reduce speed before turning or applying brakes. Watch out for ditches, logs, rocks, depressions and embankments. Always reverse up steep slopes, for greater safety, particularly when not towing an implement.
6. For older models without rollover protection, consult the suppliers on how to fit proper protective devices.

WAYS TO PROMOTE COOPERATION

Plan the operation of vehicles on slopes carefully, following the advice of experienced operators. Group discussion about the safest way helps greatly.

SOME MORE HINTS

- Beware of striking obstructions or sudden height differences, as they can cause the vehicle to overturn.
- Avoid working alone. Ask somebody with training and experience to help.

POINTS TO REMEMBER

Rollover protection frames are essential for avoiding serious rollover injuries. Follow strictly the precautions for operating vehicles on slopes safely, such as driving and turning at slow speeds.



Figure 47a. Add heavy attachments at low positions on a vehicle to lower its centre of gravity.

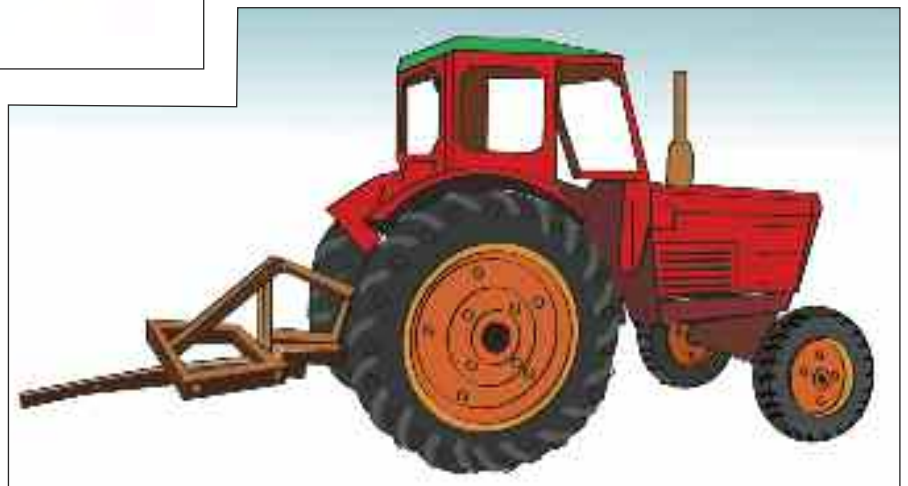

Figure 47b. Attachments at the rear of a vehicle can lower the centre of gravity and act to reduce the risk of unexpected overturning.



Figure 47c. Avoid operating an agricultural vehicle along a slope exceeding 15 degrees.

CHECKPOINT 48

Arrange the different parts of vehicles so that the driver can easily see the carried objects.

WHY

An increasing variety of agricultural vehicles are being designed for specific operations on the farm. For these vehicles, good visibility for the driver is an important part of the safety measures.

As attachments are a major cause of obscured views in vehicle operation, make arrangements to increase visibility of the surroundings.

In field conditions, agricultural vehicles are often used for carrying materials and farm products. Ensure good visibility from the driver's position.

HOW

1. Check the visibility of the surroundings from the driver's position of agricultural vehicles. Discuss how visibility can be ensured in field conditions.
2. Make sure that the driver can see the direction of vehicle movement without obstruction. Fixing attachments properly at low positions can help; if necessary, consult the supplier on how to do this.
3. Attach additional mirrors to increase the visibility of the front, side and rear surroundings. The positions and directions of the mirrors can be modified according to the needs of individual operators.
4. Rearrange the positions of materials and farm products carried by the vehicle. Never put them in places that affect the driver's view.
5. New types of equipment for increasing the visibility of the surroundings may be considered, after careful testing.

WAYS TO PROMOTE COOPERATION

Discuss with co-workers ways of ensuring the driver's view in various field conditions. Try mirrors or other simple means of increasing vision.

SOME MORE HINTS

- Check the visibility from the driver's position as part of systematic safety measures for vehicle operations. It is always useful to discuss improvements of vehicle safety in accordance with changes in day-to-day operations.
- Take special care when turning the vehicle in farm fields. Look for ditches, depressions, bumps and other obstacles, so as to avoid accidents and damage.

POINTS TO REMEMBER

Visibility during vehicle operations is an essential part of safety measures. Increase visibility from the driving position according to the needs of individual operators.



Figure 48a. Ensure visibility from the driver's seat. Good visibility is one of the features of this compact rice-transplanting machine that make it easy to operate.



Figure 48b. Mirrors can increase the front and rear views for the driver.



Figure 48c. Control positions and seat arrangements can contribute to good visibility of the surroundings.



Figure 48d. Visibility from the driving seat can be improved by a special screen showing the image from a camera on the front or rear of the vehicle.

Physical environment

Farmers often work in hot and humid environments. For your health and safety, it is important to reduce exposure to strong sunlight, heat and cold. There are practical measures to protect you when working in these extreme environments. It is useful to combine the use of daylight and lighting equipment, and the use of natural ventilation and protection from heat. Where there are potential sources of hazardous chemical emissions, it is important to enclose or cover these sources as much as possible. Pay particular attention to safety and health in dealing with animals, as they present specific hazards relating to injuries and infectious diseases.

CHECKPOINT 49

Increase the use of daylight in buildings by means of high windows and skylights, and by painting the walls in light colours.

WHY

Daylight is the best and cheapest source of illumination. The use of daylight reduces energy costs. Appropriate illumination at the workplace improves job efficiency, and minimizes mistakes or risk of accidents. Moreover, physiologically, daylight is an effective stimulant to the human visual system and the human circadian system. Psychologically, daylight and a view out are much desired, regardless of the country where people live.

Appropriate colours for walls and ceilings are very important. Walls and ceilings with light colours increase the reflection of light, resulting in better lighting conditions and energy saving. Walls painted with light colours also create a good environment for efficient work, make the room more comfortable and help minimize mistakes.

HOW

1. Open windows and doors to allow more light into your house and indoor workplaces. Clean windows regularly. Remove obstacles near windows that prevent daylight from entering.
2. Identify where more light is needed in your workplace and house. Check your work-stands, kitchens or other places. Reposition some of the workplaces closer to the daylight source.
3. Enlarge existing windows to get more daylight inside the house for your work.
4. Use transparent materials or a translucent plastic panel in the ceiling or the roof to allow more daylight to enter.
5. Choose light colours to paint or decorate walls and ceilings. You could use (for example) the white sides of used calendars or white fertilizer bags to brighten up walls and ceilings. Clean walls regularly.

WAYS TO PROMOTE COOPERATION

Visit several workplaces in your village and find good examples where maximum daylight is used. The good examples might include relocation of workplaces, light walls or transparent materials, for example. Promote the exchange of experiences with your neighbours. Many actions for improvement don't cost much, and they can increase job efficiency.

SOME MORE HINTS

- Avoid working at night if you can do the work during the daytime and take maximum advantage of daylight.
- Be aware that windows and skylights could warm up your house in hot weather. In cold weather, be aware that they may cause a loss of warmth.
- Use curtains or screens at the window to adjust the incoming light.

POINTS TO REMEMBER

Daylight is the best and cheapest source of illumination.



Figure 49a. Choose light-coloured paints (or materials such as white fertilizer bags) to brighten up walls and ceilings. Move the workstation nearer the windows.



Figure 49b. Use transparent materials or a translucent plastic panel in the ceiling or roof to permit more daylight.



Figure 49c. Position workstations near to doors or windows to take advantage of daylight.

CHECKPOINT 50

Relocate lights, or provide task lights, to ensure that there is sufficient lighting for the type of work being done.

WHY

Sufficient lighting is required, especially for precision or inspection work. This is also true for handling of farm products. An easy way to get enough lighting is to relocate lights nearer your work, so as to have more light at the work surface.

Appropriately placed task lights greatly improve the quality and safety of work. A combination of general and local lights is also useful to meet the specific requirements of different tasks.

HOW

1. Provide sufficient lighting, considering the nature of the tasks. Check whether more light is needed to improve the quality or safety of work. This is particularly important for precision or inspection work, such as dealing with high-quality products.
2. Where appropriate, change the height or positions of lamps and the direction of light falling on objects. You can also try to change the positions of work tables to obtain better lighting.
3. Place local lights near and above precision or inspection work. Local lights with a proper shield should be in a position where they don't cause disturbing shadows or glare for the eyes of the worker.
4. Always ensure a good combination of general and local lights. This helps keep an appropriate contrast between the working position and the background.
5. Regularly maintain the lighting equipment. Clean lamps and windows regularly. Change worn-out bulbs and tubes.

WAYS TO PROMOTE COOPERATION

People usually know where they need more light for safer and more productive work. Discuss with co-workers and among family members where you can improve lighting, such as for work done indoors, and done in the evening or very early morning. There are many ways of improving lighting at low cost.

SOME MORE HINTS

- Combine the use of daylight and lamps; this is usually the most acceptable and cost-effective way to improve lighting.
- Where appropriate, use local lights that are easy to move and arrange in a desired position.
- Consider the age of the persons doing precision or inspection work. Older people need more light.

POINTS TO REMEMBER

Provide sufficient and good-quality lighting at minimum cost. Combine general and local lights where appropriate.



Figure 50a. Relocate lights to obtain sufficient lighting for precision or inspection work.

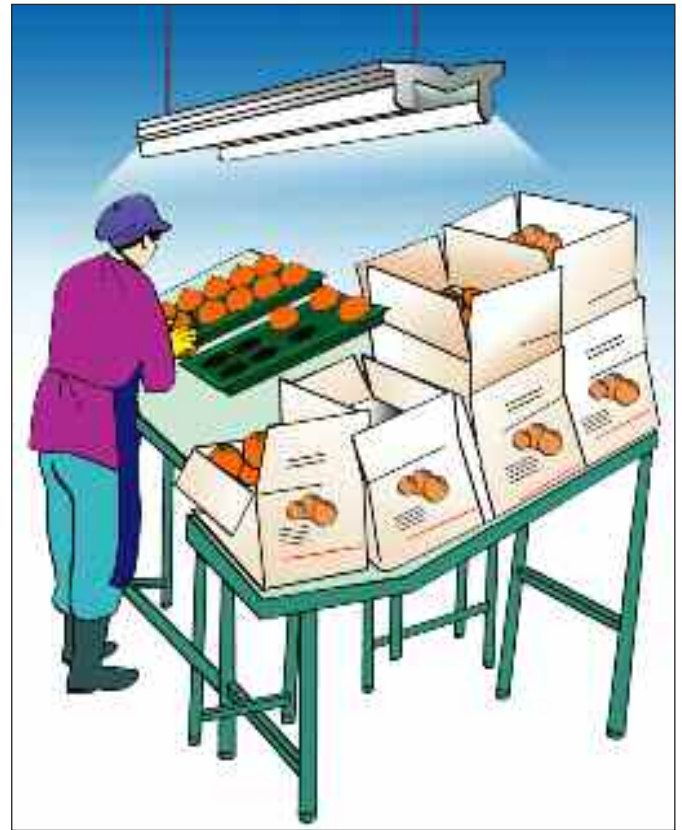

Figure 50b. Make sure that the lights are bright enough without causing shadows or glare.



Figure 50c. Provide a task light for precision work. You can check the appropriate position for the light by considering the type of work done.

CHECKPOINT 51

Improve the heat protection of buildings by backing the walls or roofs with insulating materials.

WHY

During a hot summer or in the tropics, the heat outside is too strong. In outdoor work, it is often necessary to make use of shades or screens. For indoor work, the first thing to do is to reduce the amount of sunlight coming into the house or workroom.

An effective way to reduce solar radiation coming into the house or workroom is to install insulation for buildings. There are also other ways of reducing the effects of solar radiation at low cost.

HOW

1. Install insulating materials under roofs or on walls to reduce heat penetration into the house or workroom. Avoid roof or wall materials that are easily heated up by solar radiation. Good ceilings can also reduce heat coming into the building.
2. In hot climates, paint the outside surface of roofs and walls in light colours. This helps reflect more sunlight and reduce the heat inside.
3. Use shades, canopies and screens so that solar radiation does not warm up walls or workrooms. Shades or screens that interrupt the sunshine falling on walls are particularly useful.
4. Protect workers from heat radiation from hot surfaces and heated equipment. The best way to reduce heat radiation reaching the workers is to put screens, barriers or insulated walls between the heat source and the worksite.
5. Plant trees, bushes, flowers and grass to protect against the sun's heat and dust from the outside.

WAYS TO PROMOTE COOPERATION

Learn from examples of protection from the heat of the sun in your neighbourhood. Excessive solar heat is an everyday problem, and there are many examples of ways to reduce its effects. There are different useful ways of using the effects of insulating materials, shades, screens and other methods. Try to apply cost-effective methods as shown by these examples.

SOME MORE HINTS

- The use of reflective or coloured glass is useful for reflecting sunlight. For example, it is helpful to paint the upper part of the window glass with a water-based solution of blue dye.
- Use curtains or screens at the windows to reduce the effects of solar radiation inside the room.

POINTS TO REMEMBER

Use multiple methods to reduce the effects of outside heat and sunlight. When combined measures are used, they make a real difference.

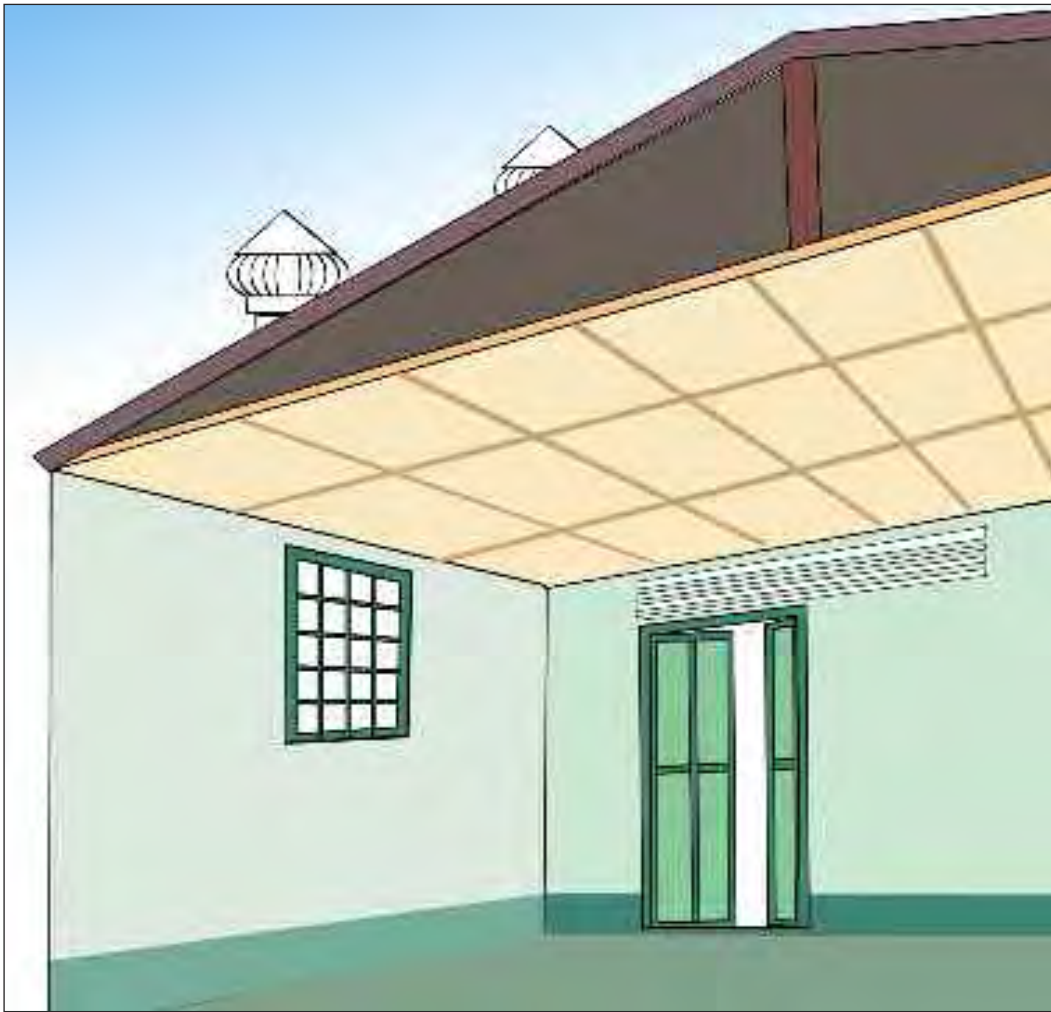

Figure 51a. Use insulating materials under roofs and on walls, and provide good ceilings. Air inlets and outlets for increasing airflow can also help reduce the effects of heat.

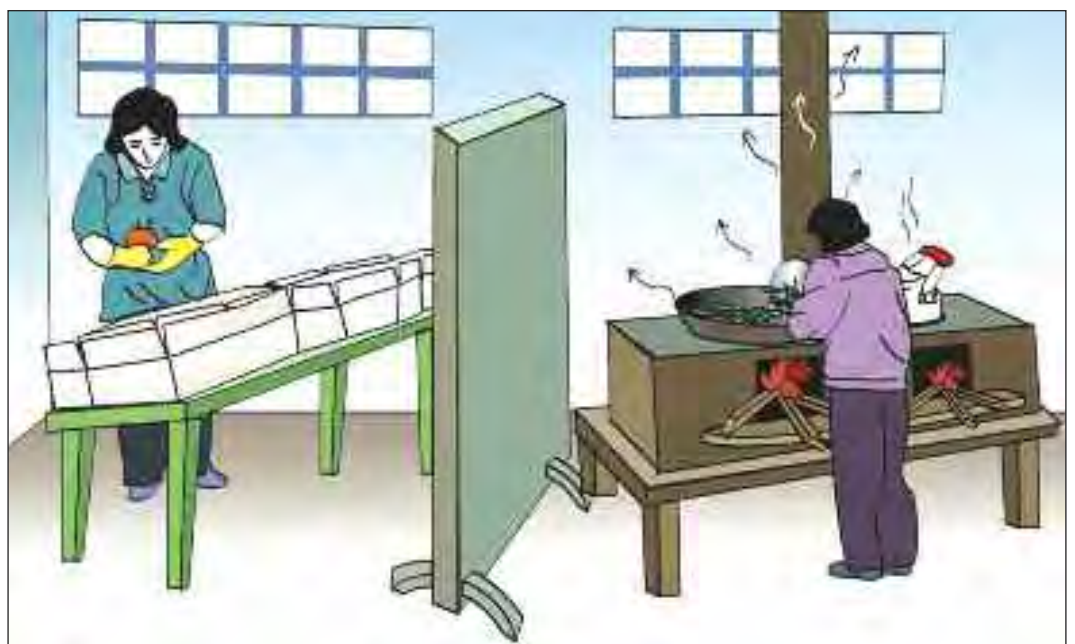

Figure 51b. Make use of screens or barriers to protect workers from heat radiation from heated equipment or walls.

CHECKPOINT 52

Avoid continuous exposure to excessive heat or cold.

WHY

Farmers often start work early in the morning to avoid exposure to strong sunshine. Working in strong sunlight decreases efficiency and productivity. It can cause exhaustion, skin problems and even shock to farmers. Working in strong sunshine causes a significant loss of water from your body.

Ultraviolet (UV) radiation is part of sunlight, and is of major significance for human health. Overexposure to solar UV radiation may result in acute and chronic health effects in the skin, the eyes and the immune system. In the most serious cases, skin cancer and cataracts can occur. UV radiation is higher when the sunlight increases, and reaches its maximum level when the sun is at its maximum elevation, at around midday (solar noon) during the summer months.

In the cold season, start work relatively late, or increase indoor work. Heat exchange between the scalp and the surrounding air is very efficient, and the head is sensitive to cold. Wear a scarf around your neck, or a jacket that zips up to your neck.

HOW

1. Protect your skin against strong sunshine. Light-coloured, long-sleeved clothes are appropriate when working in strong sunshine.
2. In cold weather, wear clothes in layers. Layers tend to trap air better, and air acts as an insulator: the more layers of insulation, the better. Clothes made of natural materials tend to breathe better. This is particularly useful when you are active and start to sweat: you need to evaporate this sweat so that you don't become cold later when you are less active.
3. Wear a hat with a large brim, or a towel, to cover the head to reduce UV radiation and heat.
4. Improve your work schedule to reduce exposure to strong sunlight or cold. In the sunny season, start work early, and avoid working at noon.

5. In the cold season, start work relatively late, or increase indoor work. Be aware that you lose more heat through your head than through any other body part, so always wear a hat. Wear a scarf around your neck, or a jacket that zips up to your neck.

WAYS TO PROMOTE COOPERATION

Farmers have many good ideas for protecting themselves against excessive heat and cold. It is particularly important to arrange appropriate work schedules to reduce exposure to heat and cold. Facilitate the exchange of experiences to set better work schedules. Another important collaboration is to share good examples of protective clothes made from local materials. Raise awareness of the need for protection against excessive heat or cold.

SOME MORE HINTS

- Take frequent short breaks when working in strong sunlight.
- Where possible, do heavy work such as carrying heavy loads in the early morning or late afternoon, when the sunshine is less strong.
- Choose a hat with a large brim to protect you from sunshine.

POINTS TO REMEMBER

Adjust work schedules and use protective clothes to avoid excessive exposure to heat or cold.

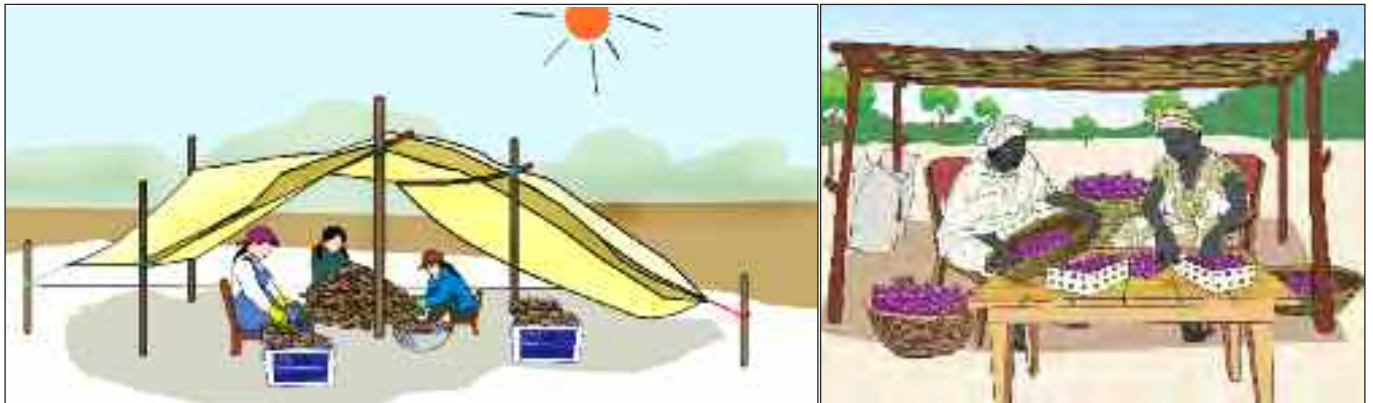

Figure 52a. Pitch a simple shelter near the working area when working in strong sunlight.

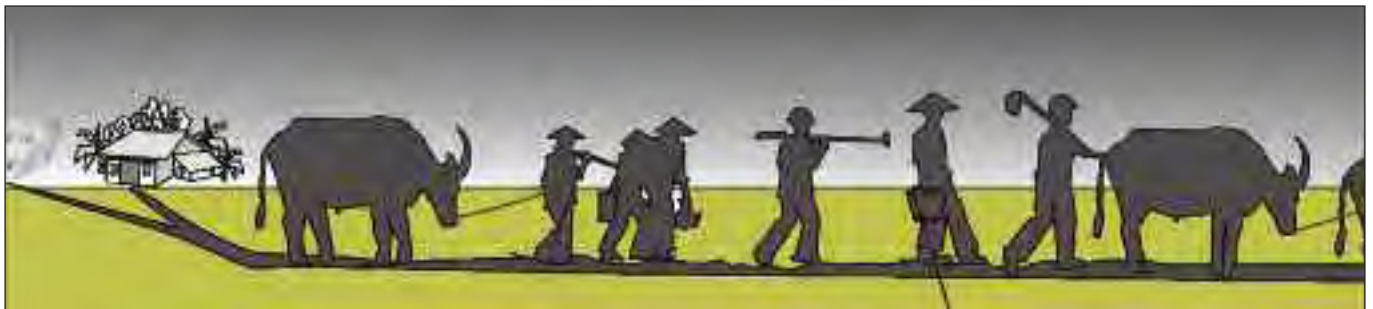

Figure 52b. Start working early to avoid the strongest sunlight around noon time.



Figure 52c. Choose thick, long-sleeved shirts and broad-brimmed hats for protection against UV radiation and heat when working in the field.

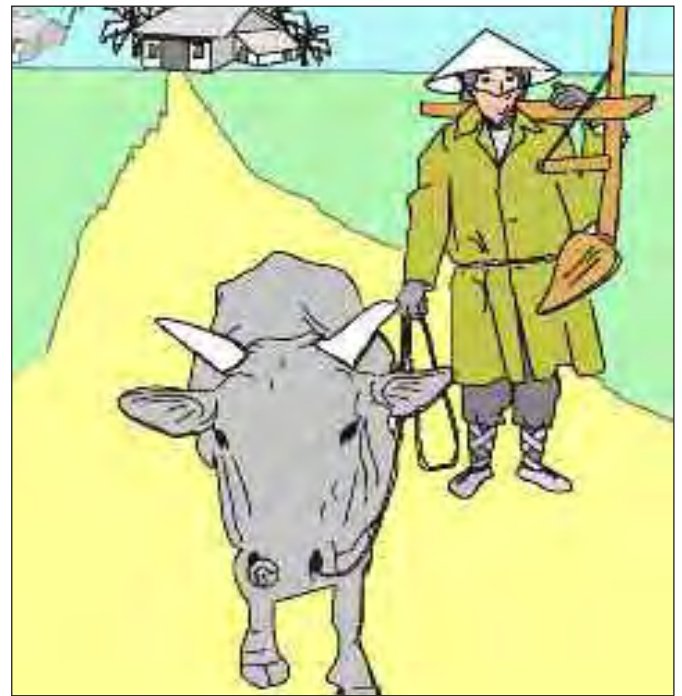

Figure 52d. Prepare blouse, hat, gloves, canvas boots and other appropriate clothing for protection from the cold before coming to the farm.

CHECKPOINT 53

Increase natural ventilation by having more openings, windows or open doorways for indoor workplaces.

WHY

Fresh air is a source of health and energy. A good, natural airflow takes away heat and polluted air from your house and indoor workplaces. A hot, poorly ventilated environment is unhealthy. Farmers and their family members will get tired easily. Job efficiency will decrease, and the number of mistakes will increase.

Farmers often work indoors to pack farm products, or to repair agricultural tools. Their families spend much time in the house for cooking, eating, sleeping or studying. The natural airflow should always be increased, except in very cold weather. A poorly ventilated environment is especially harmful to older people and children.

HOW

1. Choose places with good natural airflow for kitchens and other indoor jobs. This is particularly important in the hot season.
2. Increase the number of openings and windows. Make existing windows larger, or remove obstacles from windows for better airflow.
3. Make small openings in the roof. Natural upward airflow will release heated air through the openings.
4. Use electric fans in situations where sufficient natural airflow is not secured.
5. Open all windows regularly and frequently. Remove materials that prevent good indoor ventilation.

WAYS TO PROMOTE COOPERATION

Visit your neighbours' indoor workplaces and houses. Look at how natural airflow is used. Learn from good examples. Exchange experiences to improve indoor climates.

SOME MORE HINTS

- Move or isolate the heat sources in your house, such as cookers, furnaces or machines that produce heat.
- Install ceilings under the roof when appropriate. Ceilings will cut down heat radiation from the roof.

POINTS TO REMEMBER

A good natural airflow takes away heat and polluted air from your house and indoor workplaces.

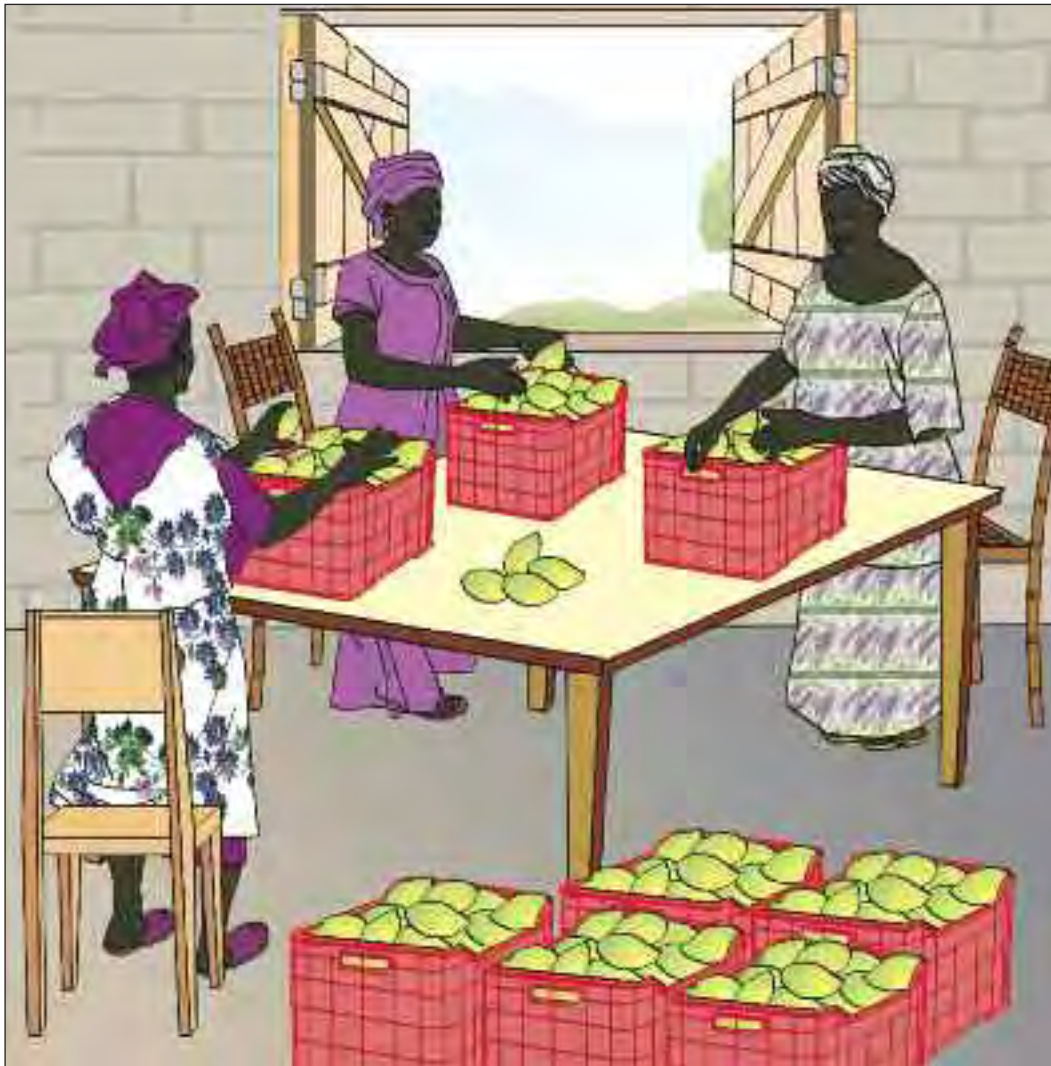

Figure 53a. Open more windows and doors. Install more louvre skylights or small windows for good airflow.



Figure 53b. Use open doorways to increase natural ventilation.



Figure 53c. Select the best-ventilated area in the house to install the work stand. Place the table near a window. Remove obstacles that prevent natural ventilation.

CHECKPOINT 54

Supply sufficient airflow to silos, and other confined places where oxygen deficiencies may occur, before entering them.

WHY

Confined places that are airtight, or are poorly ventilated, can be very dangerous, as workers entering them are exposed to oxygen deficiency, toxic gases or hazardous substances remaining inside. Examples are silos, pits, tanks and airtight storerooms. By taking suitable precautions, workers can enter them safely.

The danger of confined places is not readily visible. Utmost care must be taken, by following the specific instructions about work inside these places. Only trained workers should be allowed to enter them.

HOW

1. Get advice from persons experienced in work procedures in confined places; identify confined spaces that require entry permits. Make sure that only trained persons are permitted to enter these places.
2. Check the oxygen concentration and the presence of toxic gases inside the confined place before entering it. Make it a strict rule that, before entering, the confined space must be sufficiently ventilated with fresh air. When you have no instrument to measure the oxygen level or toxic gases, one practical way, after sufficient ventilation with fresh air, is to use a lighted candle to give a rough idea of the adequacy of the oxygen concentration, and to use live animals to test whether there are toxic gases present.
3. Make sure that sufficient natural or mechanical ventilation is maintained, to ensure that safe conditions are maintained while working in the confined space.
4. In spaces where these conditions cannot be met, permit entry only for workers equipped with airline masks or other protective devices.
5. Work in a team in a confined space. Ensure that no one is left behind when the work inside the space is finished.

WAYS TO PROMOTE COOPERATION

Establish special precautions for entering confined spaces. Follow the precautions strictly by getting advice from persons qualified for work in confined places. Get training in entering these places as a team, and work as a team in confined spaces.

SOME MORE HINTS

- Never work alone in a confined space if you don't know, or aren't sure, whether there is adequate oxygen, or whether toxic gases are present.
- Make it a strict rule to wear the designated types of protective equipment inside confined spaces.
- Provide adequate lighting for work inside confined spaces at all times.
- Have a plan for rescue if things go wrong.

POINTS TO REMEMBER

The danger of confined spaces can lead to fatal accidents. Permit entry only to trained workers, who work as a team.



Figure 54a. Establish a rule that only trained workers with an entry permit can enter a designated confined space. The oxygen concentration and the presence of toxic gases must be monitored before entering the space.

Figure 54b. Supply sufficient airflow when work is done inside a confined place to avoid accidents due to oxygen deficiency.

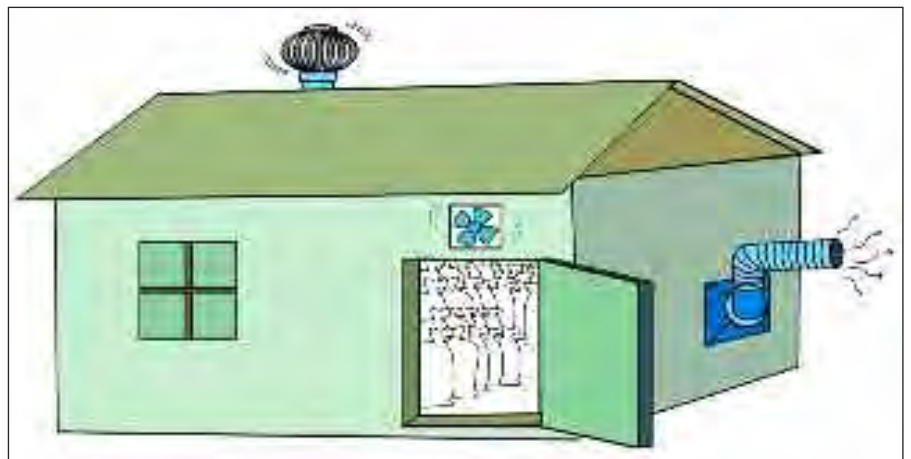
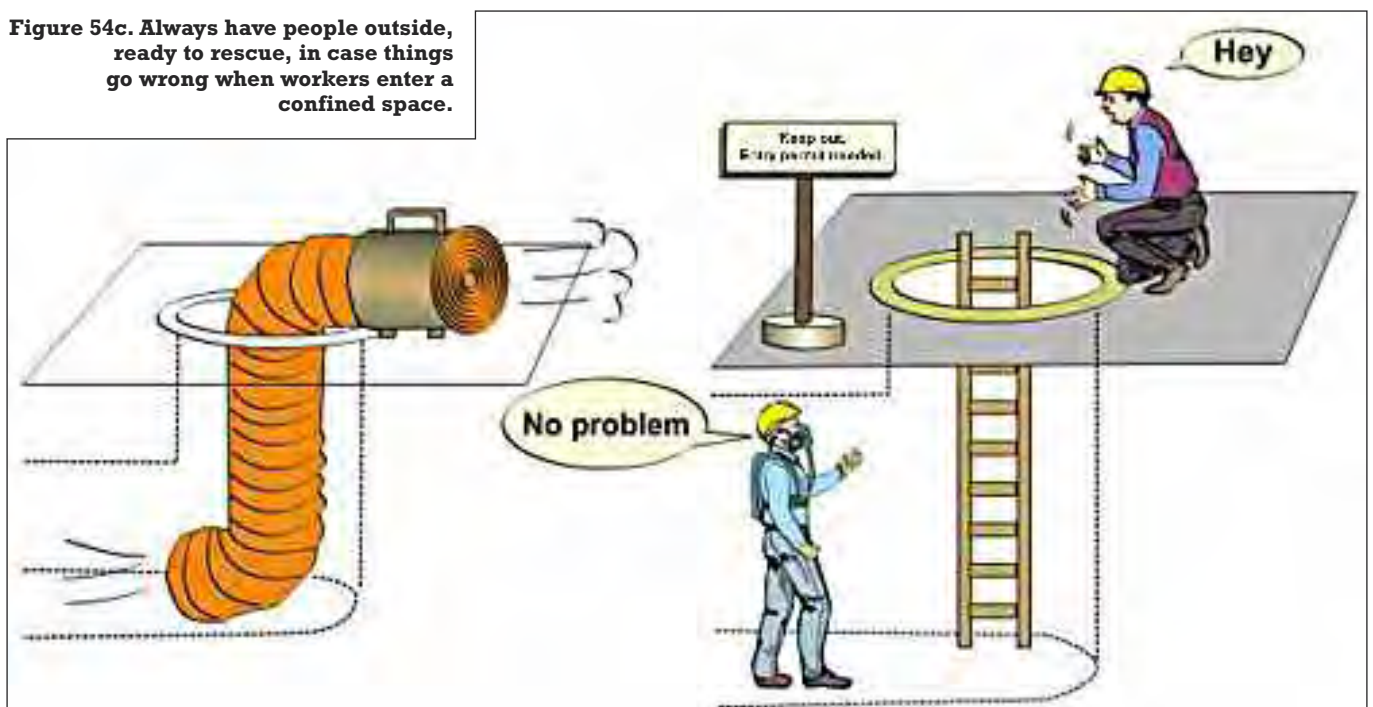

Figure 54c. Always have people outside, ready to rescue, in case things go wrong when workers enter a confined space.



CHECKPOINT 55

Reduce vibration and noise affecting workers in order to improve safety, health and work efficiency.

WHY

Workers in agriculture are often exposed to vibration and noise produced by machines and vehicles. Excessive vibration and noise at work not only disturb the work, but can also cause vibration-induced diseases or noise-induced hearing loss. These effects can be prevented by reducing exposure to such vibration or noise while at work.

Noise or vibration that are too high can also cause accidents, as work is disturbed and warning and other signals may not be noticed. By reducing the noise or vibration, or isolating their source, these unfavourable effects can be avoided.

HOW

1. Enclose the entire machine that is producing excessive vibration or noise. If this is not possible, make arrangements to reduce the transmission of vibration, or enclose particularly noisy parts of the machine.
2. If possible, place particularly noisy machines in a separate room, or outside, so that workers not working at the machines are no longer exposed to the noise.
3. Provide screens between noisy machines and workers to reduce the noise level for the workers.
4. When using vibrating tools, cover the handles with vibration-insulating foam, and provide vibration-absorbing gloves. Reduce vibration exposure time, and avoid continuous exposure to vibration.
5. If continuous exposure to excessive noise cannot be prevented, wear earplugs or earmuffs to reduce the noise reaching the ears.

WAYS TO PROMOTE COOPERATION

If you are unable to speak in a normal tone of voice standing at arm's length from another worker, then the noise level is harmful to hearing. Discuss among co-workers the ways to reduce exposure to the noise or to wear earplugs or earmuffs during work. Remember that the use of personal protective equipment is the last resort when technical measures cannot prevent exposure to excessive noise.

SOME MORE HINTS

- Purchase hand tools with low vibration and a low noise level.
- Put up signs indicating the need to wear personal protective equipment against noise or vibration.

POINTS TO REMEMBER

If workers are exposed to excessive noise or vibration, steps must be taken to enclose or screen the source, or to wear protective equipment.



Figure 55a. Workers working near a noisy machine should be protected by placing it in a soundproof enclosure.

Figure 55b. Install machines producing vibration on platforms that can reduce the transmission of vibration to surrounding areas.

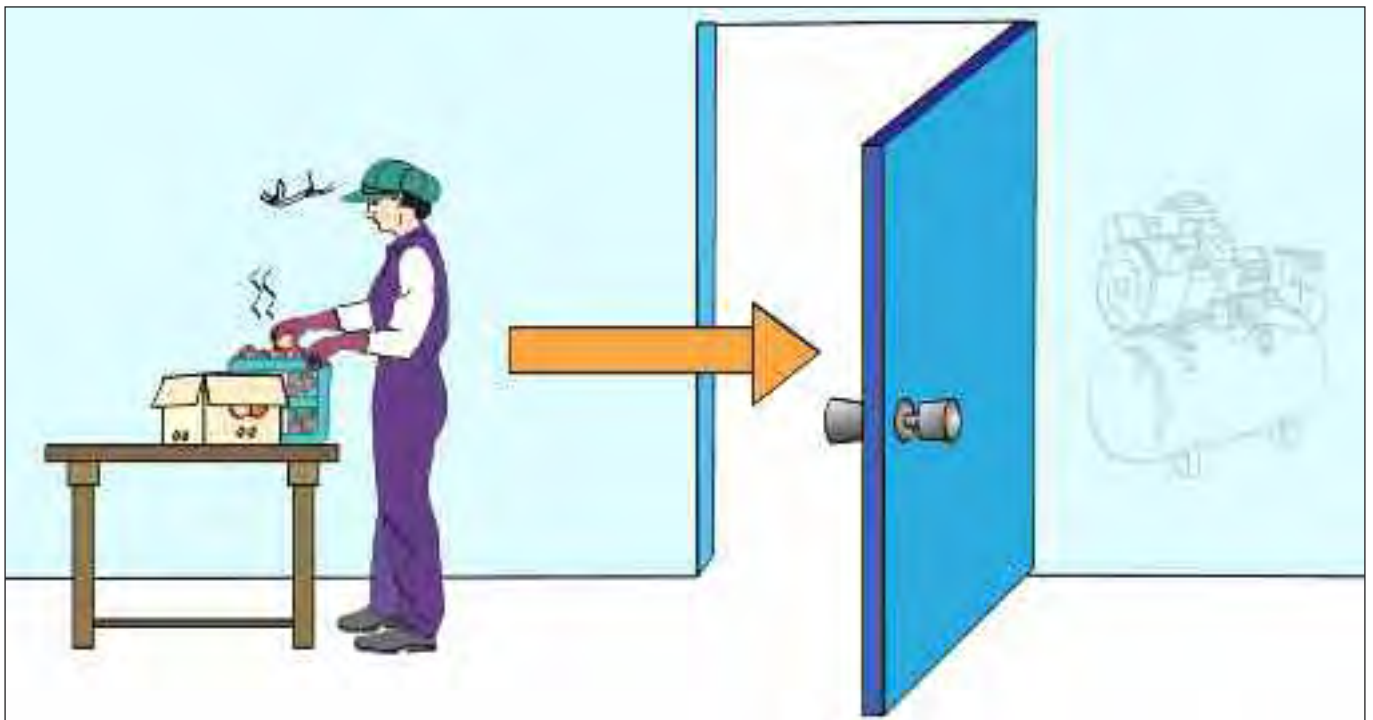
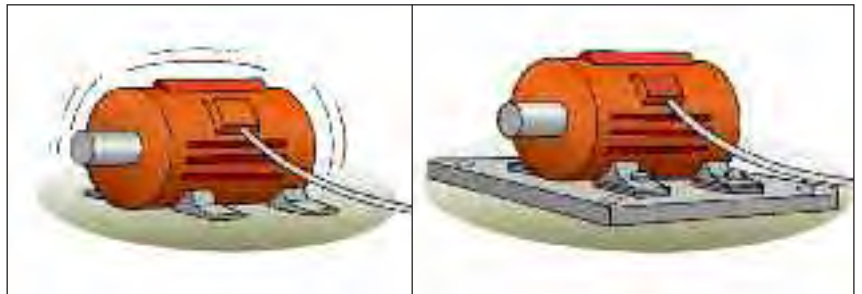

Figure 55c. Make sure that workers in a room adjacent to a room where a noisy machine is in operation are protected by closing the door between the rooms.

CHECKPOINT 56

Isolate or enclose sources of dust.

WHY

Agricultural workers are exposed to dust in both outdoor and indoor work. Dangerous dust is not always visible. Very small particles in the air can enter deep into the lungs when inhaled. These particles may be absorbed into the body tissue and cause incurable scarring, known as pneumoconiosis, or even cancer. It is necessary to prevent such serious diseases by controlling exposure to dust.

The best way to reduce exposure to dust is to isolate or enclose the sources of dust at work. It is often necessary to utilize local exhaust systems, or to use personal protective equipment such as respirators.

HOW

1. Avoid doing work producing dust in a narrow space or a poorly ventilated workroom. If it is appropriate, do the work outside, or under a roof erected in an open space. Avoid working downwind of the dust-producing machine.
2. Cover or enclose a dust-producing machine to reduce dust in the breathing zones of workers. An exhaust system is required to extract the contaminated air to a place away from the workers.
3. Use the push-pull type of ventilation to avoid working downwind of dusty air.
4. Use an anti-dust respirator if work with a dust-producing machine in a poorly ventilated place is unavoidable. Get the advice of specialists knowledgeable about protection against dust.
5. Rearrange your work schedules to reduce exposure to dusty air, but be aware that work schedules alone cannot avoid the effects of dust completely.

WAYS TO PROMOTE COOPERATION

Visit workplaces where the protection of workers from dust-producing machines is well designed. Learn from the positions of workers in relation to the machines, and the effective local exhaust systems. Experiences about respirators can give you good guidance.

SOME MORE HINTS

- When purchasing machines that produce dust, select those that prevent dusty air in the breathing zones of operators. Enclosed machines, and machines with a local exhaust system, should be preferred.
- When hoods are used, place them properly, considering airflow. Advice from experienced specialists is needed.
- Consult the suppliers of machines or respirators about proper protection from dust.

POINTS TO REMEMBER

Use push-pull ventilation or local exhausts to reduce dust from your machines.



Figure 56a. Choose machines that have a good enclosure combined with an exhaust system.

Figure 56b. Avoid dusty air entering your breathing zone. Learn from good experiences in your neighbourhood about reducing dust in your breathing zone.

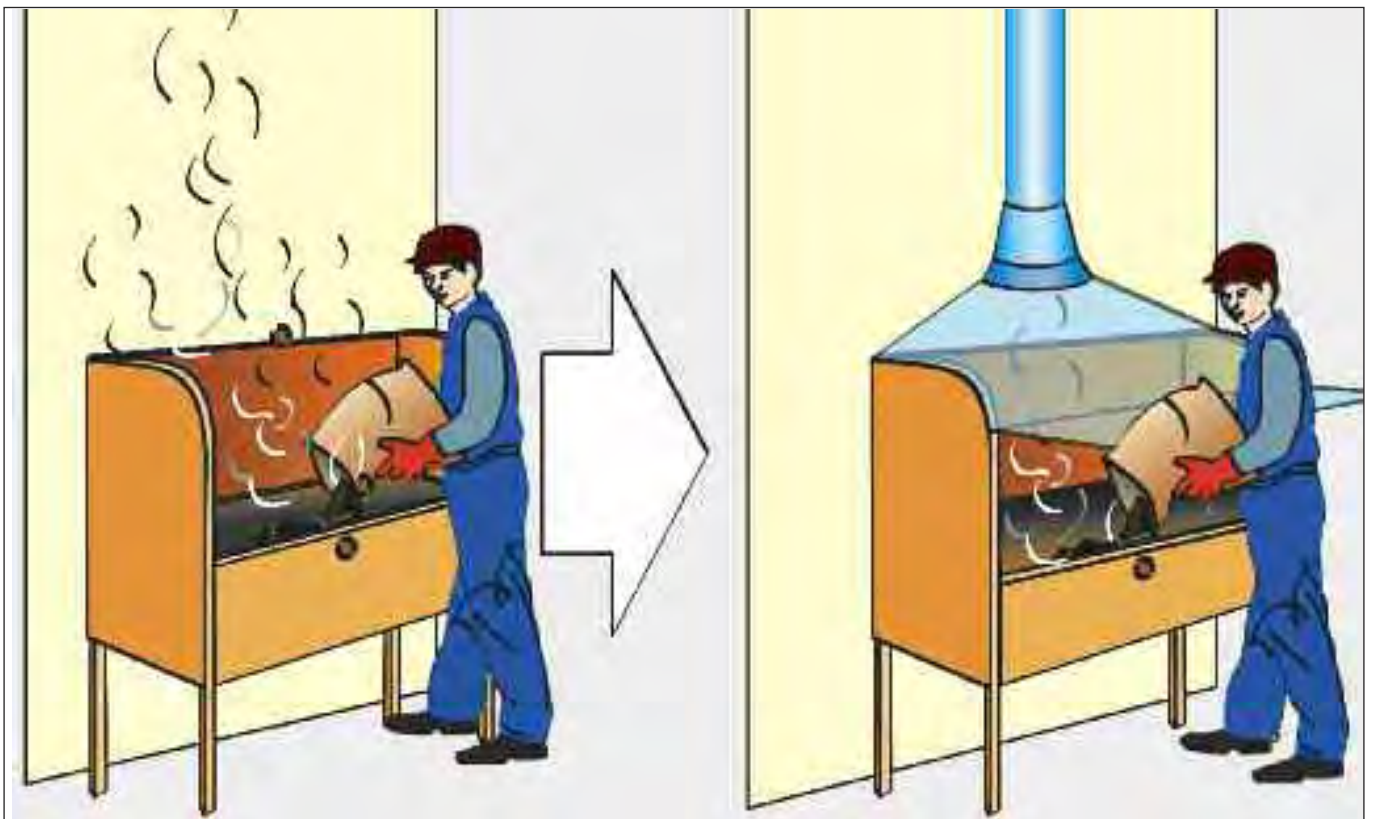

CHECKPOINT 57

Introduce or improve local exhaust ventilation.

WHY

When farmers have to deal with hazardous substances, good airflow is very important. Adequate ventilation helps farmers avoid excessive exposure to these substances. Local exhaust ventilation that creates airflow moving from the farmer towards the polluting sources (and to the outside) greatly helps reduce the unnecessary exposure.

It is important to install a local exhaust that can collect polluted air effectively. Take special care to ensure that the polluted air does not come into the breathing zone of the farmer. Simple changes in the location of the exhaust and the hood shape, or relocation of the working area, can often solve the problem.

HOW

1. Choose ventilation equipment that is effective in collecting the polluted air that can affect farmers working near the polluting sources. Consult a supplier with good knowledge and experience of such equipment.
2. Use both push-type and pull-type ventilation in a good combination. Place push-type ventilation in areas where there is no danger of polluting other places, and pull-type ventilation at or near polluted worksites. The pull-type fan should have a capacity larger than a push-type fan.
3. Position ventilation duct inlets and outlets or fans where they are most efficient for collecting polluted air. Obtain advice from ventilation equipment manufacturers or experienced specialists.
4. Establish a practice of opening windows. This can increase cross-ventilation and help extract polluted air.

WAYS TO PROMOTE COOPERATION

Learn from good installed local exhaust systems by obtaining the advice of ventilation manufacturers or specialists. It is useful to visit workplaces that combine effective push-type and pull-type ventilation. Experiences in collecting polluted air by changing the location of ventilation equipment or the hood shape are particularly helpful.

SOME MORE HINTS

- Hot air rises, so the use of ceiling fans and high openings can improve ventilation.
- Don't rely solely on ventilation equipment to prevent exposure to polluted air. Take measures to eliminate or isolate the sources of pollution.
- Maintain ventilation equipment with the advice of manufacturers or specialists.

POINTS TO REMEMBER

To reduce exposure to polluted air, use push-type and pull-type ventilation properly. Get specialist assistance.

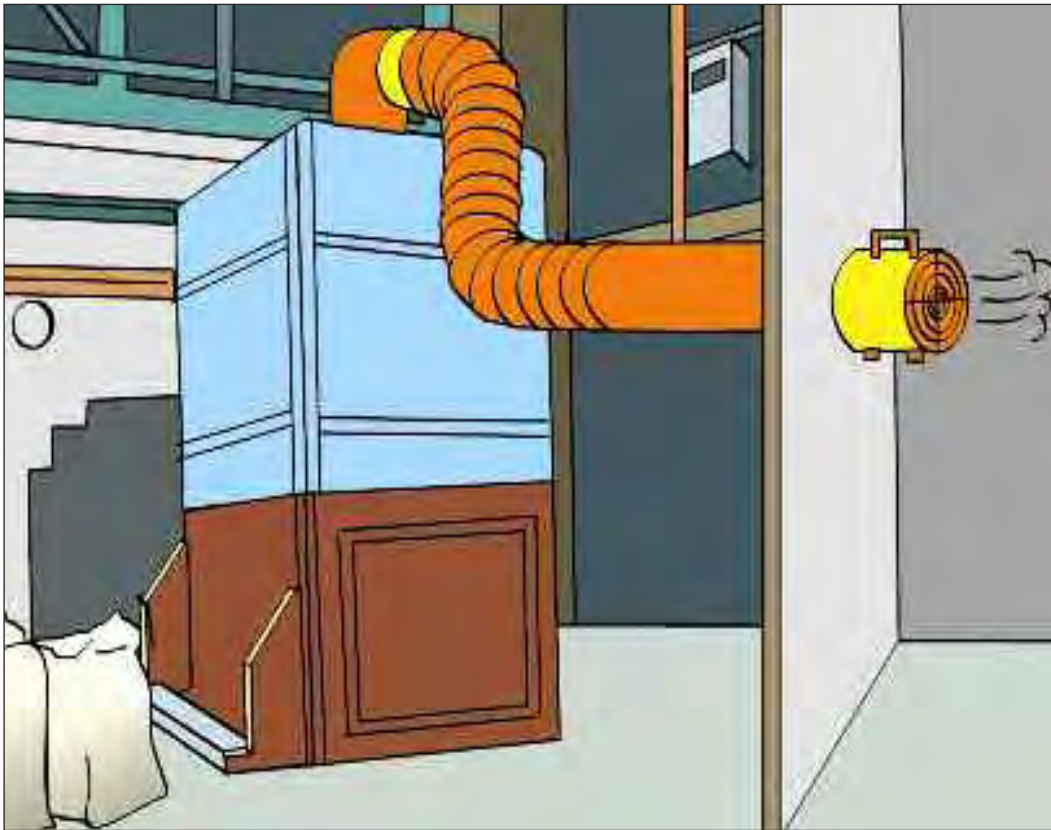
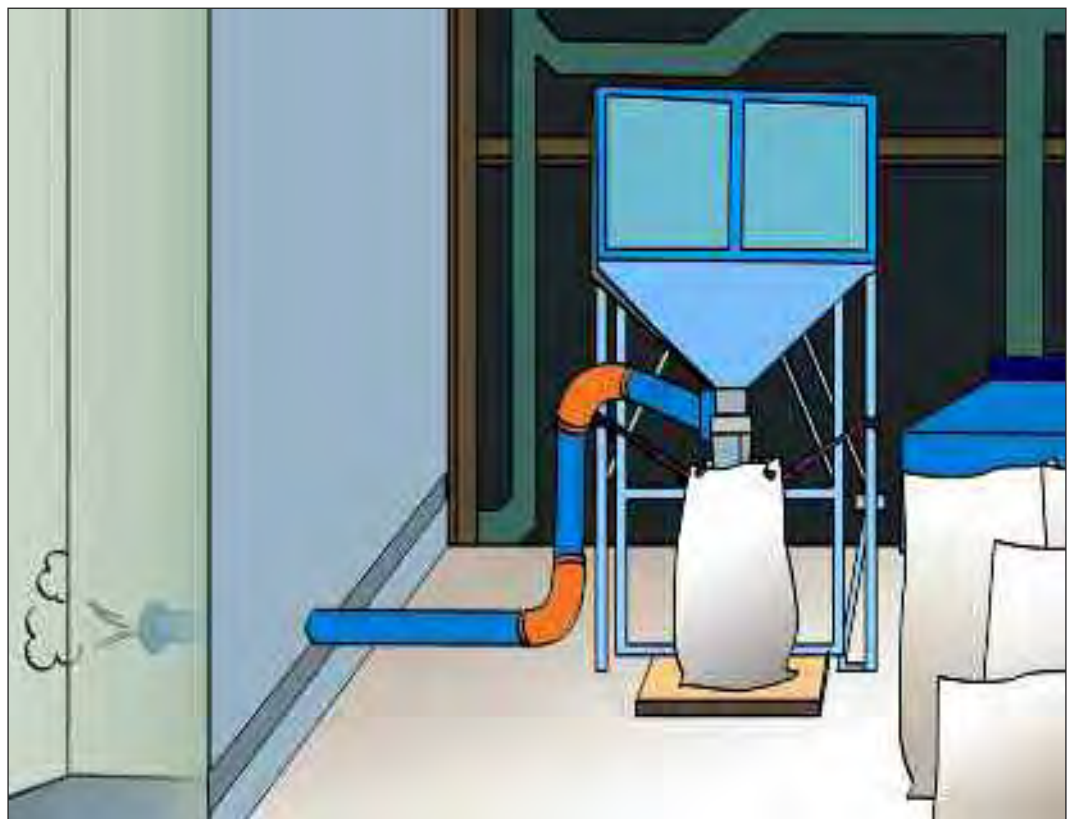

Figure 57a. The most effective way to extract polluted air is to apply an enclosing system. Make sure that the collected polluted air does not come into the worksite.

Figure 57b. When enclosed systems cannot be applied, use local exhaust equipment to remove hazardous substances at source.



CHECKPOINT 58

Provide sufficient fire extinguishers within easy reach, and make sure that workers know how to use them.

WHY

It is essential to detect a fire while it is still small, use fire extinguishers installed at the workplace, and alert the emergency service for fires as soon as possible. The provision of portable fire extinguishers is the most important fire protection measure. A sufficient quantity of fire extinguishers placed in designated places and clearly marked can greatly reduce the risk of large fires.

It is important to provide adequate types and quantities of extinguishers, and to train workers in how to use them. Adequately applied and properly positioned fire extinguishers can dramatically quench the flame of fires.

HOW

1. Select appropriate types of portable fire extinguisher. Check all the fire extinguishers placed in and around the workplace. Make sure that the proper classes and types of extinguisher are in place (Class A for ordinary solid combustibles such as paper and wood; Class B for flammable liquids; Class C for flammable gases; Class D for flammable metals; Class E for electrical fires; and Class F for cooking oil and fat).
2. Mark clearly the places where fire extinguishers are placed. It is often advisable to put them on the wall so that they are easily visible.
3. Provide a sufficient number of fire extinguishers within about 20 m from every place where a fire may occur.
4. Train workers in the appropriate use of fire extinguishers. Usually, an extinguisher is used by pulling the pin, aiming the nozzle at the base of the flames, squeezing the trigger while holding the extinguisher upright and sweeping it from side to side to cover the area of the fire.
5. Maintain fire extinguishers on a regular basis. Make sure that pins, nozzles and nameplates are intact, and that no extinguishers are missing or empty.

WAYS TO PROMOTE COOPERATION

It is essential that all people know the appropriate use of fire extinguishers. Fire drills are indispensable for ensuring the proper use of extinguishers in an emergency. In order to keep people aware about fire protection, make an agreement involving all people in the household or in the workplace about what to do in case of a fire.

SOME MORE HINTS

- Put a notice on the wall with the important phone numbers for fire-fighting and protection people.
- Make sure that all people know they should not fight a fire if it is spreading beyond the spot where it started, or if it might block the only escape route.

POINTS TO REMEMBER

Maintain a sufficient number of fire extinguishers placed within easy reach.



Figure 58a. Provide sufficient fire extinguishers at clearly designated places within easy reach from places where people work or live.



Figure 58. Make sure that appropriate types of fire extinguisher are placed near a work area where there is a risk of fire.

CHECKPOINT 59

Provide sufficient appropriate personal protective equipment for workers, and maintain it regularly.

WHY

Personal protective equipment is essential when technical measures cannot prevent potential excessive exposure to hazards encountered at work. Protection by personal protective equipment is a “last resort” measure, and can be ensured only by its regular use. Therefore sufficient personal protective equipment of appropriate types must be provided.

When personal protective equipment is properly worn and regularly maintained, it can protect workers effectively from the corresponding hazardous conditions. It is important to train farmers about its proper use.

HOW

1. Discuss what types of personal protective equipment are needed to protect people exposed to various hazardous conditions. Ensure that a sufficient quantity of each type of personal protective equipment is available. Consult the suppliers to get proper advice.
2. Write down what types of personal protective equipment are required for different kinds of agricultural work. Make this information known to all people concerned. It is useful to designate a person who is responsible for keeping this information.
3. Train all people using personal protective equipment about its proper use.
4. Regularly check the use and maintenance of personal protective equipment. Discuss whether any improvement is necessary to ensure that it is correctly used and maintained. Consult specialists or reliable suppliers if you are in any doubt.

WAYS TO PROMOTE COOPERATION

Organize a team of people with experience in the use of personal protective equipment. The team members should visit the worksites, both indoors and in the fields, and examine whether improvements are needed to ensure its correct and regular use. If it is not regularly used, discuss the reasons why, and measures to correct the situation.

SOME MORE HINTS

- Disseminate information about the proper use of protective equipment to all people exposed to each particular kind of hazard that requires personal protection.
- Special care is needed for respirators: the appropriate types, airtight wearing and proper maintenance.
- Convince workers of the need to wear personal protective equipment, even if it causes inconvenience for the user, and try the equipment first to make sure it fits the workers.

POINTS TO REMEMBER

The regular use of personal protective equipment at work saves money and prevents human suffering.



Figure 59a. It is essential to fit personal protective equipment to each individual. Make sure that well-fitting equipment is provided and used.



Figure 59b. Always select equipment that is effective and comfortable: for example, lightweight equipment with maximum protection.



Figure 59c. Maintain the place used to store personal protective equipment in good order, so that the equipment is easily accessed when it is needed.

Figure 59e. The maintenance of personal protective equipment should be well planned, and done by a trained person.



Figure 59d. The filters used for dust respirators are not effective for gases or vapours, and vice versa. Always use the correct types of respirator. Replace the filters in respirators frequently, in accordance with the suppliers' instructions.



CHECKPOINT 60

Treat animals in ways that cannot do harm to farmers.

WHY

The treatment of animals always requires the utmost care. Be aware that animals may harm you unexpectedly, or transmit disease by close contact. Such unexpected events can be prevented if you follow carefully the instructions of experienced farmers and specialists.

Knowledge of animal behaviour, including unexpected movements and contacts, helps you avoid problems. There are well-established procedures for treating animals, and it is essential to get training about them.

HOW

1. Learn from senior farmers and animal husbandry specialists about animal behaviour, and the correct way to treat the animals you encounter during your farming work. It is essential to know how to prevent the injuries and diseases that might affect you during animal treatment.
2. Make sure that animals are handled by persons who are well trained in their safe treatment.
3. Carefully observe the established procedures and the use of protective arrangements and devices to avoid injuries that might be caused by unexpected movements of the animals you are treating (sudden kicking by the hind legs, for example).
4. Clean the animal facilities regularly. Assign this responsibility to well-trained workers.
5. Observe the hygiene precautions required when treating animals. Animals may be affected by infectious diseases that may be transmitted to human beings. Hygiene precautions are therefore important, especially when treating animals in close contact, or for examination purposes.

WAYS TO PROMOTE COOPERATION

Visit the animal facilities of experienced livestock farmers, and find good examples of animal treatment. These examples may include special cages to restrict unexpected movements, or sanitary arrangements. Discuss with your neighbours cost-effective methods of animal treatment.

SOME MORE HINTS

- Separate animal facilities from living quarters as much as possible.
- Use appropriate work clothes and protective equipment when treating animals. Keep them in separate, designated places.
- Follow specific instructions for preventing infections from animals.

POINTS TO REMEMBER

Make sure that animals are handled only by trained persons. This helps you prevent unexpected injuries and diseases.

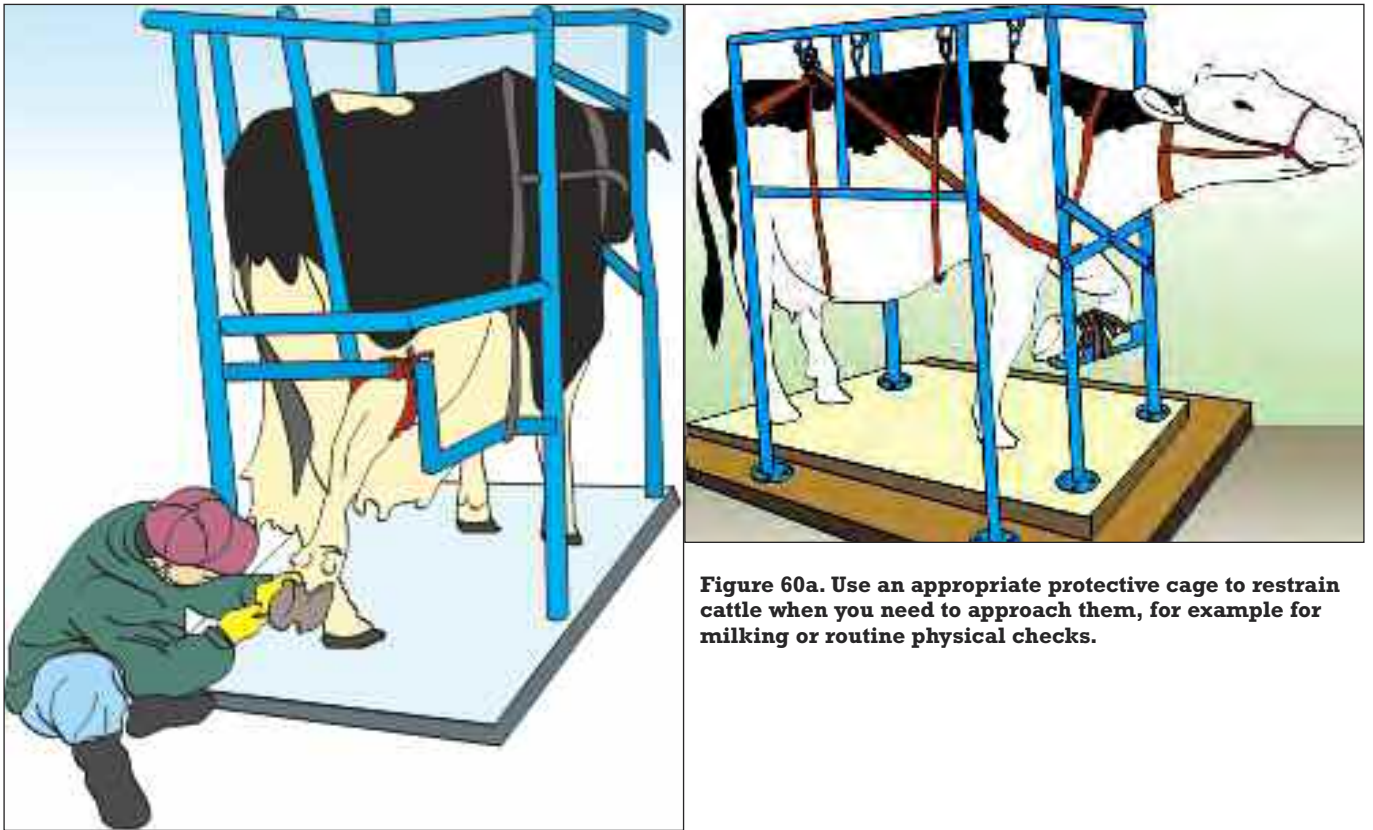

Figure 60a. Use an appropriate protective cage to restrain cattle when you need to approach them, for example for milking or routine physical checks.



Figure 60b. Keep the animal facilities clean and hygienic, and try to improve them.

CHECKPOINT 61

Be aware of animals and insects that might harm farmers unexpectedly.

WHY

Ensure the use of appropriate personal protective equipment when working in fields and farms. Farmers need to protect themselves against pests, insects and animals such as snakes, centipedes, leeches, jungle leeches, mosquitoes, wasps and bees. Frequent exposure to nuisances by insects or worms in the field will also reduce your working speed, interrupt your workflow and increase your fatigue.

Domestic animals can cause serious health and safety problems. For many farmers, these nuisances are quite common. Severe trauma or disease could be caused by contact with cows, pigs, horses or poultry, or by exposure to insects such as wasps, bees or mosquitoes. Some farmers may underestimate the dangers, and forget the appropriate protection.

HOW

1. Canvas shoes, boots, gloves, broad-brimmed hats and long-sleeved shirts are useful personal protective equipment for outdoor work.
2. Wear a helmet with face protection while working in areas where there are winged insects such as mosquitoes, wasps or bees.
3. Poultry and cattle must be kept in closed sheds or within the farming area. Avoid any contact with dangerous poultry or cattle without wearing protective equipment.
4. Make sure that first-aid kits are readily and easily reachable. They should contain supplies and equipment appropriate to the harm and injuries that the animals and insects might cause to farmers.

WAYS TO PROMOTE COOPERATION

Look at your neighbours. Find out the types of shoes, boots, gloves, hats and other protective equipment used in the field that protect farm workers the best and with the least discomfort. Exchange ideas on how to protect yourself from animals, insects and worms. Discuss the benefits of protection.

SOME MORE HINTS

- There are various local methods used to avoid exposure to dangerous animals and insects. Some farmers use limes to remove leeches from their bodies. Limes can also reduce the pain caused by insect bites and bee stings. Smoke can drive bees away. It is advisable to collect such wisdom, to avoid exposure to insects and other nuisances.
- All trays, farming equipment and sheds must be regularly disinfected with an appropriate disinfectant.

POINTS TO REMEMBER

Use appropriate shoes, boots, gloves, hats and other protective devices to protect yourself.



Figure 61a. When working outdoors, use appropriate equipment to protect you against any animals or insects that might harm you.



Figure 61b. Wear a helmet with face protection while working in areas where there are winged insects.



Figure 61c. Poultry must be kept in closed sheds, and the shed must be regularly disinfected. When contact with poultry is necessary, farmers should be protected with safety equipment.



Figure 61d. Wash your hands regularly with the correct soap.

Control of hazardous chemicals

Farmers are increasingly using many kinds of agrochemical, such as pesticides, herbicides and plant growth regulators, which pose increased safety and health risks at work. The health problems caused by agrochemicals can even spread to your community and the consumers of your agricultural products. This chapter provides many useful tips for the safe and minimum use of agrochemicals. The ideas include information dissemination, labelling, safe ways of keeping pesticides, and methods for safely handling and using agrochemicals and their containers.

CHECKPOINT 62

Put labels on all containers of pesticides and other hazardous chemicals.

WHY

Clear and easy-to-understand labels on the containers of pesticides and other hazardous chemicals are essential to ensure their safe use. Even if you are already familiar with these chemicals, the labels are needed to protect your family and neighbours against dangerous misuse.

The labels of the containers are often written in technical jargon, or even in foreign languages. They are difficult to understand, especially for farmers or those who have not had experience with these chemicals. The wrong use of agrochemicals, such as mishandling pesticides together with herbicides, is dangerous to users. It will damage crops as well as the health of farmers.

HOW

1. Check all containers of agrochemicals, both used and unused. Label them clearly in the local language: for example, "INSECTICIDES", "HERBICIDES".
2. Don't remove labels. If labels are unclear, relabel them with the warning "VERY TOXIC". Consult village health and agricultural centres to obtain appropriate information.
3. You might purchase pesticides and other chemicals in large quantities and then divide them into smaller containers. If so, don't forget to place easy-to-read labels on each of the small containers.

WAYS TO PROMOTE COOPERATION

Labels and notices with directions for use are very useful to protect you and your family members against dangerous misuse. Exchange information with your neighbours, and encourage them to do the same. The exchange of experience in various situations of safe use of agrochemicals is really useful for everybody.

SOME MORE HINTS

- Choose pens with water-resistant and fade-resistant inks to write labels in bold lines. Use clear and easy-to-understand words: for example, "POISON, DANGER". Or use danger symbols, such as a skull and crossbones.
- Share experiences with your neighbours, and keep a good habit of maintaining clear and legible labelling on agrochemicals. This action costs nothing, but is really useful for everybody.

POINTS TO REMEMBER

Put labels written in the local language on all containers of pesticides and other chemicals to avoid the dangers of misuse.



Figure 62. Put labels in the local language on all agrochemical containers to avoid the dangers of misuse.

CHECKPOINT 63

Keep all pesticides and other hazardous chemicals in locked containers or cabinets.

WHY

All pesticides and other hazardous chemicals need careful storage for safety. They are potentially poisonous to both humans and animals. Design well-locked storage to keep hazardous chemicals away from the living area. Keep them out of children's reach.

Spraying devices contaminated with pesticides can also become a source of pollution. Placing pesticide containers and spraying devices indoors will pollute your family's living environment. Routine, everyday exposure to such a hazardous atmosphere will pose health risks for your family.

HOW

1. Choose a metal or wooden container that can be hermetically closed with a lock to hold all containers of pesticides and other dangerous agrochemicals.
2. Keep spraying devices and bottles of pesticide in a small storage shed outside your living residence, or in the field. This storage should always be locked tightly when not in use. Design multi-level shelves to store pesticides. Store herbicides and pesticides separately.
3. Use a multi-level rack or cabinet for keeping pesticides and other hazardous chemicals in good order. This solution is not costly. It is very useful for finding the chemicals you need, and for preventing dangerous misuse.

WAYS TO PROMOTE COOPERATION

Construct together a public storage house for keeping pesticides. Each family has its own corner. This solution is not costly. It enhances neighbourhood cooperation, and is very useful for preventing poisoning in the community.

SOME MORE HINTS

- Select a place away from your living residence to keep pesticides; keep them away from sources of drinking water and food.
- Store the key carefully, and out of reach of children.
- Choose a place away from the source of water to wash spraying devices. The best way is to wash them in the field you have just sprayed.

POINTS TO REMEMBER

Pesticides are poisonous and dangerous. Keep them carefully in a safe, designated place away from the home.



Figure 63a. A storage shed, with a firm lock, to keep pesticides in the field. A multi-level shelf with bottles of pesticides and agrochemicals. Keep pesticides and herbicides separate, and label them clearly.



Figure 63b. Pesticide container with a safe lock.

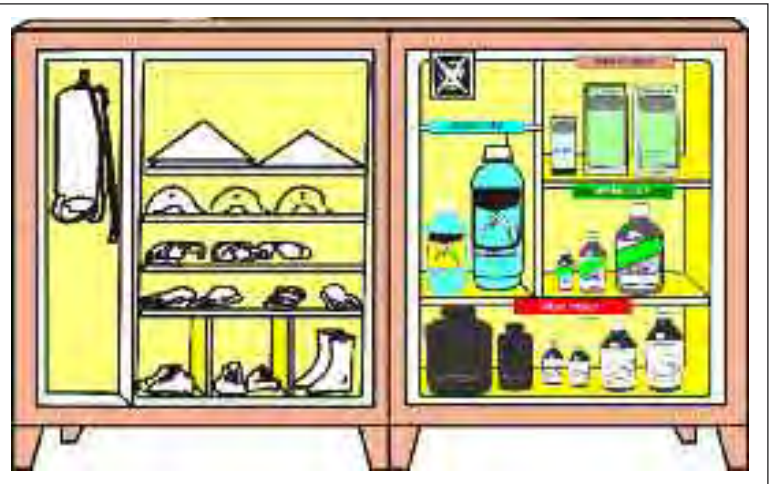

Figure 63c. Store agrochemicals separately or with other agriculture devices and instruments, such as spraying devices, gloves and masks. All chemical containers should be clearly labelled and logically arranged.

CHECKPOINT 64

Select safer pesticides, and use appropriate amounts of them.

WHY

Farmers need to use pesticides properly and wisely. Select the right kinds of pesticide and other agrochemicals that are safe, and use the minimum amount, to reduce the risks of poisoning. As well as acute poisoning, some chronic diseases, such as neuritis, chronic liver disorders or some types of cancer, might also be partly related to exposure to pesticides and some agrochemicals.

Pesticides are poisonous, not only to the sprayers but also to the consumers of your agricultural products. Pesticide residues could exist in your agricultural products and cause harm to the people who eat them. By using appropriate pesticides in a correct manner, you can contribute to the safety and health of your customers.

HOW

1. Before relying on pesticides, farmers should know what kind of pests they need to tackle. Compare pesticides with other solutions, as there could be alternative ways to control pests.
2. If pesticides are the only available solution, ask agricultural advisers or health centre personnel for advice and information on selecting and using safer pesticides properly.
3. When spraying pesticides, wear appropriate protective gloves, goggles, shoes and clothing.
4. Make a plan to minimize the amount of pesticides used. Don't use banned pesticides in your field.
5. Never mix different pesticides and other agrochemicals by yourself. The mixture may increase your health risks.

WAYS TO PROMOTE COOPERATION

Collect information on best practice in the safe use of pesticides and other agrochemicals from farmers who use them, and exchange experiences. On the farm, use break times to share information concerning wise methods to reduce the amount of pesticides. Increase knowledge on the effect of different kinds of pesticide. Develop an "agrochemical users' club" to facilitate information exchange about pest control, and the safe use of pesticides and dangerous agrochemicals.

SOME MORE HINTS

- Ask pesticide suppliers and manufacturers to provide chemical safety data sheets. It is their primary responsibility to deliver safety and health information to their customers.
- Television, radio and publicity material will provide you with useful information on safety and health in agriculture, and on the safe use of pesticides and dangerous agrochemicals. Don't miss these.

POINTS TO REMEMBER

Use pesticides safely and wisely. You will reduce the health risks to you, as well as to your consumers.



Figure 64a. Ask the agricultural adviser for advice before purchasing pesticides.



Figure 64b. Together with agricultural advisers, identify the pest before selecting a suitable pesticide.



Figure 64c. Consult suppliers on the safe use of pesticides.

CHECKPOINT 65

Indicate clearly each operation related to pesticides that requires the use of personal protective equipment.

WHY

Personal protective devices provide protection for specific parts of the body against hazardous agents or substances. The selected protective devices must be used properly. If not, they can give farmers a false sense of security: this is very dangerous.

A wound can greatly increase pesticide absorption. Absorption is a particular hazard through wounded or abraded skin. It is very important to protect your feet from injuries. In some tropical countries it is common for farmers to work without wearing shoes in the field or on the farm. Bare-footed farmers are likely to be injured by pieces of broken bottles or sharp nails lying on the field. The wound on the bottom of the foot, even if small, increases difficulty in work. Injuries of this area of the body are hard to keep clean. Severe complications such as infection or even tetanus could develop.

Residues can be inadvertently transferred from a hand to a sweaty part of the body. Avoid using pesticide-contaminated hands to wipe sweat, particularly on the forehead, face and neck. Broad-brimmed hats and long-sleeved shirts protect farmers from heat and strong sunshine. Appropriate protective masks are needed when handling hazardous agents or spraying pesticides.

HOW

1. Provide shoes with thick soles for treading on the wet soil or the vegetable farm to avoid cuts to the feet and absorption of pesticides through the skin of bare feet. Tuck trousers into the shoes when working on humid or muddy soil. Provide boots for working in the rice field.
2. Choose gloves suited to your jobs to protect your hands from cuts and to avoid direct contact with pesticides. Use thick gloves for jobs that require grip strength, or jobs handling sharp, pointed items, such as picking up sugar-cane leaves or weeding in the pineapple field. Use thin gloves for precision work, such as picking and thinning out of branches. Use rubber gloves when handling agrochemicals and fertilizers.

3. For spraying pesticides, choose masks containing filters containing granules of activated carbon. Never use a mask with an expired filter.
4. Clean and maintain every protective equipment regularly.

WAYS TO PROMOTE COOPERATION

Encourage people to try wearing personal protective equipment before they actually spray pesticides or other dangerous agrochemicals. Ask them to be patient. Users need time to adapt to wearing the devices. Promote the regular use and maintenance of personal protective equipment.

Maintain personal protective equipment properly to prevent cross-contamination.

SOME MORE HINTS

- Check whether the mask fits the shape of the user's face. Even small spaces between the mask and the face could cause leaking of chemicals, and hence reduce the mask's effectiveness.

POINTS TO REMEMBER

The regular use of personal protective equipment will reduce injuries and exposure to hazardous substances.



Figure 65a. Boots and shoes used in farming to protect the feet from cuts.



Figure 65b. Helmets and glasses to protect the eyes.



Figure 65c. Mask, with filter containing granules of activated carbon, for use when spraying with pesticides.



Figure 65d. Store and maintain personal protective equipment properly to prevent cross-contamination.

CHECKPOINT 66

Collect safety and health information, such as on the safe use of agrochemicals, and disseminate it to farmers and to the community.

WHY

Nowadays there are many kinds of agrochemical appearing on the market, with different uses, dosages and toxicities. Select the right agrochemicals and apply the correct dosages. This will protect your crops, and prevent risks of poisoning.

Local agricultural departments and community agro-promotion units are reliable sources for obtaining relevant information on the safe use of agrochemicals.

HOW

1. Consult and get advice from the local agro-promotion personnel or agricultural experts to ensure good decisions on buying the correct pesticides or agrochemicals.
2. Collect information in pamphlets, flyers, newspapers or on the radio about the toxicity and safe use of agrochemicals. Disseminate this useful information to your neighbours.
3. Organize training and retraining workshops for farmers in the vicinity, getting the assistance of local agencies, suppliers and technical specialists. Always include practice sessions to learn the correct use and disposal of agrochemicals.

WAYS TO PROMOTE COOPERATION

Encourage your neighbours to exchange experiences and information for the safe use of agrochemicals. It is a good idea to ask health and agricultural experts to conduct seminars on the safe use of pesticides and other agrochemicals.

SOME MORE HINTS

- Note the trade names of your pesticides, and keep a record. This information will be useful when you ask the agricultural or health experts for further information.
- Join the local agro-promotion clubs to update your knowledge on how to choose the correct pesticides, and to receive new information on pests and how to detect and prevent them.

POINTS TO REMEMBER

The right knowledge and understanding of the safe use of agrochemicals will protect you and your family.



Figure 66a. Get advice from the local agricultural experts before purchasing pesticides.



Figure 66b. Use break times to share experiences with your neighbours on the safe use of agrochemicals.

Environmental protection

Many kinds of agrochemical, such as pesticides and herbicides, are used in agricultural work. Proper use of agrochemicals is not only important for the farmers who use them, but also has an impact on family members, the community and the environment. In rural areas where agriculture is the main economic activity, and in small farms, the living and working areas are normally mixed. The health problems caused by agrochemicals can spread to your community, and even to the consumers of your agricultural products. This chapter provides many useful tips on how to protect the environment through the safe and minimum use of agrochemicals. The ideas include information on ways to use agrochemicals in an environmentally friendly manner, how to handle used agrochemical containers, and how to minimize waste and reduce pollution.

CHECKPOINT 67

Establish safe methods for dealing with used pesticide and chemical containers.

WHY

It is important to establish safe methods for dealing with waste pesticide containers. Waste pesticide bottles and boxes littered in crop fields or canals will cause pollution. This is extremely dangerous to human beings, to animals and to the environment. Moreover, broken bottles might injure farmers while they are working in the field.

Waste agrochemical containers must be disposed of properly. Don't reuse them for any purpose, and particularly not for household use. Many farm workers have been poisoned by using the waste bottles for household or other purposes. Waste containers may still contain small amounts of poison, that could even kill people or animals.

Empty containers must be disposed of safely in the designated area. It is dangerous to collect and sell agrochemical bottles. The buyers may mix pesticide bottles with other bottles. It is particularly dangerous if the labels of these bottles are removed. Instead of going back to the pesticide factories, the collected bottles might even be reused in a beverage factory!

HOW

1. Empty agrochemical containers should never be reused for any purpose.
2. Choose a safe disposal site for burying agrochemical wastes.
3. Collect all bottles that have been thrown out and are littered in the field; send them back to the suppliers for recycling. If this is not possible or feasible, put them in a covered container and bury them in a safe disposal site.

WAYS TO PROMOTE COOPERATION

Empty pesticide and agrochemical containers are toxic. Advise your neighbours to collect them and put them in a safe disposal place. It will be very important to have a community disposal site for all the villagers. Seek advice from your health or agricultural centres on proper disposal of the waste containers.

SOME MORE HINTS

- Use personal protective clothing and gloves when collecting waste pesticides containers.
- The burial site must be chosen carefully, so that there can be no risk of pollution to surface or ground water. The site must be well away from the living area. Containers and waste should be buried at a depth of at least 1 metre. The area used should be fenced or marked with warning signs.
- Obtain assistance from local agencies and suppliers in establishing proper treatment mechanisms for used containers.

POINTS TO REMEMBER

Protect your environment by adopting safe methods for disposing of waste agrochemical containers.



Figure 67a. Provide containers with covers for used bottles of pesticides and other hazardous chemicals.



Figure 67b. Choose a safe site for disposal of agrochemical waste far from the living area and sources of water.



Figure 67c. Create a community disposal site.

CHECKPOINT 68

Collect and separate waste. Recycle it so as to minimize the amount of discarded waste.

WHY

Agriculture produces a large amount of organic waste, such as surplus parts of agricultural products and animal faeces. Separating these wastes on their collection is a good start towards reusing them and protecting the environment. As many farmers are doing, surplus leaves, stalks and roots, and commercially non-saleable fruits and vegetables, can be used as foods for animals. Animal faeces can be converted into natural fertilizers.

Collect separately non-toxic waste such as paper, plastics, metals and woods. Recycling or reusing these waste materials minimizes the final amount that is discarded. Separate collection is essential; once the various waste materials have been mixed up, it is extremely difficult to separate them for reuse. Place separate waste bins, appropriately labelled, at the places where the different wastes are produced.

Separate waste collection promotes the safety of both farmers and waste collectors. Many waste collectors have been injured by hazardous waste. For example, broken bottles in a waste container can injure both farmers and family members who handle the waste.

HOW

1. Collect organic waste and use it as animal food or fertilizer. Never throw it away into canals or rivers.
2. Place separate waste containers for the different types of waste, such as metals, bottles, cans, plastics and dangerous materials.
3. Dangerous waste, such as needles, pieces of glass, corrosive materials and bottles that have contained pesticides or chemicals, should have special containers with clear signs and instructions. Send them to the suppliers or designated dangerous waste treatment facilities for recycling if possible. If this is not possible, and you can't recycle them in a safe manner, put them in a covered container and bury them in a safe disposal site.

4. Learn from good examples in your neighbourhood of the recycling of waste.

WAYS TO PROMOTE COOPERATION

Develop a system for recycling and reuse of separately collected wastes that are not harmful to your farms or communities. Discuss with your village leaders and neighbours regularly the improvement of environmental protection measures including these points.

SOME MORE HINTS

- Look at the condition of waste containers, and check whether any dangerous materials have been placed in them by mistake.
- Train farmers in how to collect waste separately and recycle the wastes that are safe and reusable.
- Seek advice from relevant local agencies on how to establish community waste collection systems and make them work.

POINTS TO REMEMBER

Collecting and reusing waste is the first important step towards protecting your community from environmental pollution.



Figure 68a. Make it a rule to separate wastes when they are collected. Attach labels showing the types of waste to be collected. Learn, from good examples in your community, how to set up separate waste containers.



Figure 68b. Use carts for carrying waste containers. This makes it easier to collect wastes separately at different locations.



Figure 68c. It is often useful to utilize waste containers whose contents can easily be seen from outside.

CHECKPOINT 69

Reduce water consumption, and protect the environment, by changing methods of water use.

WHY

Used water needs proper treatment, otherwise it can increase the burden on the general environment and pollute rivers and lakes. Collecting and treating large amounts of waste water needs a lot of public money and effort. Saving water, though, means cost savings for agricultural production.

HOW

1. Collect solid farm waste, and avoid flushing such waste with water.
2. Use batch washing first, as much as possible, for cleaning farm materials and products. Minimize continuous rinsing.
3. Collect and reuse half-dirty water, such as the water retained after washing raw materials, for uses such as flushing toilets or washing floors, as long as the water is not contaminated with toxic substances.
4. Regularly check all water pipes and valves in order to ensure there is no water leakage.

WAYS TO PROMOTE COOPERATION

Visit your neighbours' farms and see how they wash materials and products, or clean floors, machines and workstations. Discuss with your family and neighbouring farmers ways to reduce water consumption.

SOME MORE HINTS

- In meetings and training sessions about agricultural work, discuss good examples of water consumption. There should be many workable ideas.
- Establish and implement community policy and measures to reduce water consumption. Promote applications of good practice to avoid unnecessary

water consumption. Set up community water treatment facilities or recycling systems for the used water.

POINTS TO REMEMBER

Farmers' daily efforts will save a large amount of water and protect the environment.



Figure 69a. Provide washing facilities that can reduce the amount of water used.



Figure 69b. Avoid simply rinsing your materials or products. There are better ways to clean them, with reduced water consumption.

CHECKPOINT 70

Process your agricultural products in a manner that minimizes damage and decay, and avoid the use of unnecessary packaging materials.

WHY

Waste reduction is a basic requirement in environmental protection. Look at the ways you are working on your farms every day. Observe how much waste is produced from them. The first thing that farmers can do to reduce waste is to process agricultural materials and products in a way that minimizes damage and decay. This decreases the need for packaging materials, and in the end will greatly reduce waste.

Farmers use many kinds of products that are supplied in packaging, such as animal foods and fertilizers. Much of the packaging is not really necessary. Choosing materials free from unnecessary packaging reduces wastes and promotes environment-friendly production. Reducing waste by avoiding unnecessary packaging can also decrease the cost of waste treatment.

HOW

1. Consider alternative ways of packaging your raw materials such as fertilizers or animal foods, but never reuse agrochemical containers for keeping food or drinking water.
2. Select materials or products that require minimal packaging.
3. Make use of the empty packaging, and avoid the use of disposable packaging.
4. Use packaging made of natural and biodegradable materials.

WAYS TO PROMOTE COOPERATION

Farmers in a community may face similar problems of damage when processing agricultural materials and products, and also excessive packaging. Discuss ways to reduce such damage or use of unnecessary packaging materials.

SOME MORE HINTS

- Suggest that suppliers and sellers provide materials without unnecessary packaging.
- Investigate ways to reduce damage to or decay of agricultural materials and products. Based upon your observation, consider ways to improve packaging methods.

POINTS TO REMEMBER

Reduce waste by avoiding unnecessary or excessive packaging, and select environmentally friendly packaging materials.

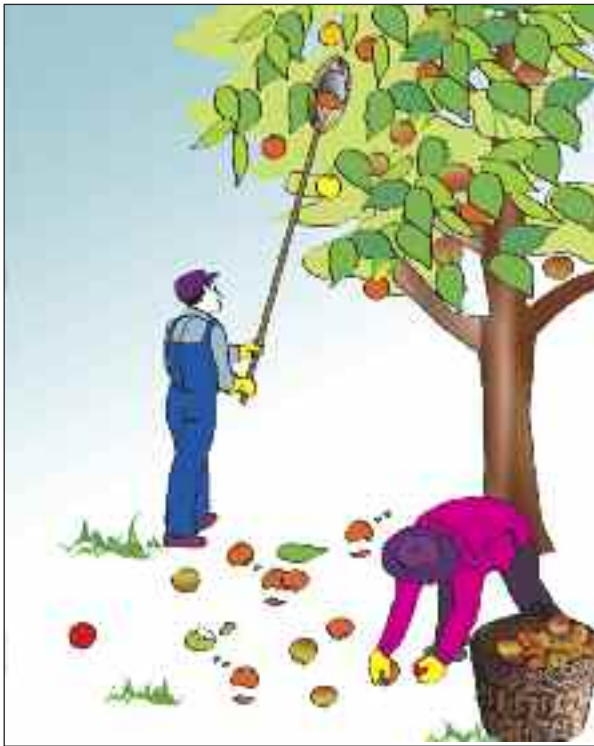

Figure 70a. There are various ways to reduce damage to agricultural materials and products on your farm. Consider new techniques that are suitable to your conditions.



Figure 70b. Use containers for your materials and products that can be reused.

Figure 70c. Find the most appropriate ways to reduce damage and packaging materials.



CHECKPOINT 71

Reduce the amount of pesticides used by promoting appropriate pest management techniques.

WHY

Many kinds of pesticide and agrochemical are available on the market. Farmers need to select the right agrochemicals, and apply the correct doses. Overuse will never improve productivity; it will merely increase toxicity and environmental pollution.

There are many practical ways to reduce and minimize the amount of pesticides used through correct spraying methods and storage. An increasing number of farmers are applying organic farming methods to reduce the use of agrochemicals. These farmers' efforts protect the environment, consumers and themselves.

HOW

1. Use the correct amounts of pesticides and agrochemicals, and avoid their overuse. Protect the packaging of pesticides to avoid leakage and damage.
2. Promote organic farming to avoid or reduce the use of pesticides by rotating crops to prevent a build-up of pest populations, encouraging natural predators to keep pest numbers down, building a healthy soil that ensures good plant health, timing cultivation to reduce the likelihood of problems occurring, and choosing appropriate species and types of crop that are less susceptible to pests and diseases.
3. Consult and get advice from the local agro-promotion personnel or agricultural experts to ensure a good decision before buying pesticides or agrochemicals.
4. Ask health and agricultural offices to conduct seminars on organic farming and the safe and correct use of pesticides and other agrochemicals.

WAYS TO PROMOTE COOPERATION

Encourage your neighbours to exchange experiences and information on the safe and correct use of agrochemicals. It is useful to learn from other farmers' good experience in the use of pesticides.

SOME MORE HINTS

- Read carefully the information that accompanies agrochemicals on their safe and correct use.
- Consult agrochemical suppliers or agricultural experts about the toxicity and safe use of agrochemicals. Disseminate this useful information to your family members and neighbours.
- Note the trade names of your pesticides, and keep a record. This information will be useful when you ask agricultural or health experts for further information.
- Ask pesticide suppliers and manufacturers to provide chemical safety data sheets. It is their primary responsibility to deliver safety and health information to their customers.

POINTS TO REMEMBER

The right knowledge and understanding of organic farming and the safe and correct use of pesticides will protect the environment, consumers and yourself.



Figure 71a. Learn from trainers about how to select pesticides appropriate for the pests in your fields, and about their safe and correct use.



Figure 71b. Information about the proper selection and use of pesticides is usually available in brochures supplied by your local agencies and suppliers. Read these brochures carefully.



Figure 71c. Be aware of the environmental effects of pesticides. The amount of pesticides used can be reduced by applying appropriate pest management techniques.



Figure 71d. Update your knowledge by attending seminars about environmental protection in agriculture.

CHECKPOINT 72

Recycle human and animal waste by utilizing appropriate biogas technologies.

WHY

Human and animal waste is a potential source of environmental pollution and public nuisance. It pollutes rivers and canals, and causes serious damage to the fishing industry. The bad smells it creates damage your village's environment, and its reputation.

HOW

1. Design animal stables for easy collection of waste. Develop a container to store the collected waste and convert it into biogas. Learn this technique from experienced farmers or local agricultural experts.
2. Apply the same system to human toilets to collect the waste and convert it into biogas.
3. Connect biogas containers to household cooking devices by using correct, safe pipelines.
4. Organize seminars to learn appropriate biogas technologies suited to your area.

WAYS TO PROMOTE COOPERATION

Waste disposal and biogas technologies are developing fast. Visit recently established facilities for treating animal waste or biogas production. Learn cost-effective ways to utilize appropriate technologies suited to your local conditions.

SOME MORE HINTS

- Check and maintain the whole biogas system regularly for safe and effective use.
- Community cooperation is important when using biogas technologies. Technical advice should be provided for farmers when they start to use this technology.

- It will be more cost-effective and efficient if several households jointly design and develop a biogas production and delivery system.

POINTS TO REMEMBER

Human and animal wastes can be converted into low-cost, environment-friendly biogas.

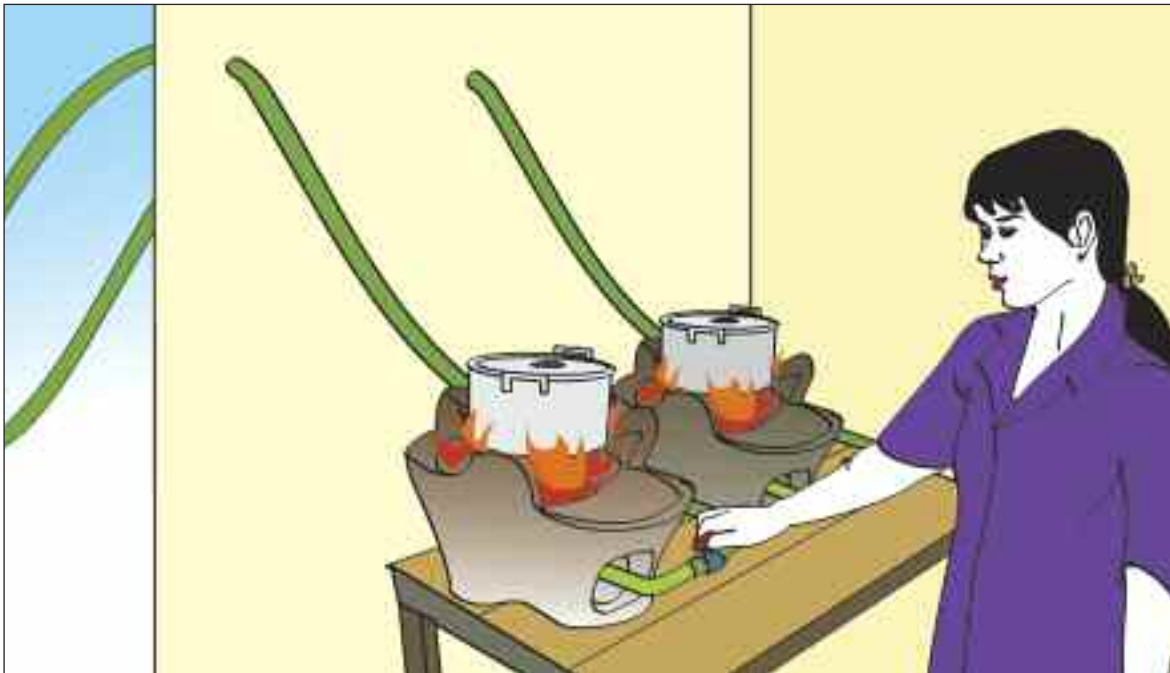

Figure 72a. Choose the biogas facilities most suited to your local conditions. Get training about treating animal and human wastes and utilizing the biogas produced.

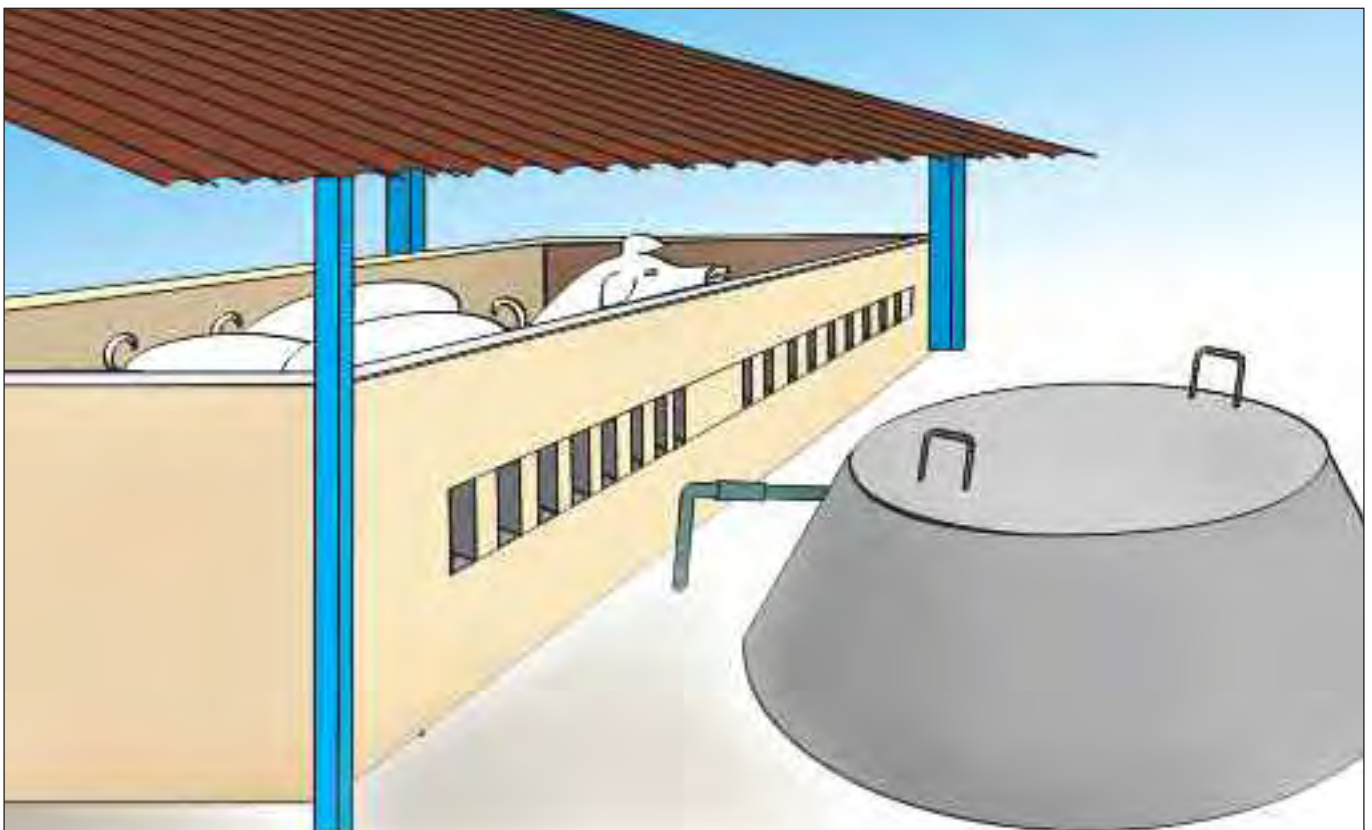

Figure 72b. Install the biogas facilities carefully. Design the sites and routes for collecting and utilizing biogas. Learn from local good examples.

Welfare facilities

The basic necessities for healthy farm work are safe drinking water at the workplace, nutritious food, hygienic toilets, short breaks and rest areas. These can all be improved by using inexpensive local resources. Pregnant women need special care. Farmers with disabilities can work actively when suitable adjustments are made to their workstations or working conditions. In this chapter you will find many practical solutions to upgrade the welfare facilities and systems that farmers need. It is apparent that neighbourhood cooperation is the key to success.

CHECKPOINT 73

Provide an adequate supply of safe drinking water and refreshments at all workplaces.

WHY

Farmers work heavily and lose a lot of water as sweat during their work. This water needs to be replaced. In a hot working environment they need even more water to maintain good health. Cool drinking water will refresh farmers and help them recover from fatigue.

Farmers working in a cold environment also need sufficient water. Much water is lost from the body while handling heavy workloads in a cold working environment. A hot drink during a short break helps farmers refresh themselves and recover from fatigue quickly.

Drinking water provided on the farm should be safe and clean. Water kept for long hours in the field might be contaminated, and could cause diarrhoea. You should use appropriate water containers to avoid contamination, and keep them in a cool and clean place near your worksite.

HOW

1. Select clean and safe water sources for drinking. Rainwater and underground water are possible choices. However, monitor the water sources carefully. Avoid using underground water for drinking if pesticides and other hazardous chemicals are used nearby.
2. Boil collected rainwater or underground water for at least 15 minutes. Pour it into a clean bottle and cork it firmly.
3. On the farm, and in the crop field, keep drinking water containers in safe, clean and dust-free places, and avoid leaving them in direct sunshine when they are not used.
4. In a cold working environment, use containers that can keep the water warm, and find a warm place for storage.

WAYS TO PROMOTE COOPERATION

Work in the sunshine is strenuous. Provide break periods as often as possible. Distribute safe, clean drinking water to all farmers at work. During busy periods, such as harvesting, many farmers have to work together and help each other. Assign one or two persons to prepare, bring and distribute safe, clean drinking water to everybody.

SOME MORE HINTS

- Use a water filter before boiling water to screen out impurities and suspended solids, sand and other debris. Regularly clean the filter and drinking water containers.
- In a cold working environment, bring a small portable stove to the farm and boil the water to prepare hot beverages.
- Don't drink alcoholic beverages during work or break periods. They will increase your fatigue, and the risk of errors and accidents.

POINTS TO REMEMBER

Bring safe drinking water to farms and crop fields to keep farmers refreshed and healthy, and to help quick recovery from fatigue.



Figure 73a. Safe drinking water should be placed near the workplace.



Figure 73b. Take appropriate water containers while working on the farm.



Figure 73c. Take a short break and refresh yourself with safe drinking water.

CHECKPOINT 74

Provide regularly cleaned toilets and washing facilities with soap close to the work area.

WHY

Clean toilets and washing facilities are essential needs of farmers. Without appropriate toilets, farmers, particularly women farmers, have to refrain from urinating. Many might avoid drinking water to reduce the need to urinate. This is harmful to health, especially when working in a hot environment.

Farmers need to wash their hands and bodies immediately after work. This is strongly recommended after they have applied pesticides and other dangerous agrochemicals. Washing facilities should be located near the work area. Farmers may occasionally be accidentally exposed to large amounts of toxic chemicals. In this case, they need urgent wash-out facilities.

HOW

1. Build a sanitary toilet near your work area. Toilets should be screened appropriately for privacy. For farmers in remote villages in developing countries, there are many types of low-cost latrine appropriate for agricultural communities. They hold human excreta long enough for disinfection.
2. Equip your toilet with a water container, paper, a garbage bin with a cover, a brush and soap. Keep your latrine clean.
3. Provide washing facilities, together with soap. Ensure sufficient water supply.
4. If many farmers use the same facility, sufficient toilets and washing facilities should be provided to be used separately by men and women.

WAYS TO PROMOTE COOPERATION

Plan together with your neighbours where to build sanitary toilets in the workplace. Farmers can share toilets when working nearby. Make a collaborative plan to keep the toilets at the workplace clean at all times.

SOME MORE HINTS

- Cultivate a good habit of washing hands after using the toilet. Provide necessary washing facilities and soaps.
- Regularly clean the toilets and washing facilities.

POINTS TO REMEMBER

Clean toilets and washing facilities near the work area are necessary for the convenience and welfare of farmers, and can increase their productivity.



Figure 74a. An enclosed toilet with necessary sanitary devices.



Figure 74b. A simple, low-cost latrine.



Figure 74c. A sanitary latrine with washing facilities near the workplace.

CHECKPOINT 75

Provide first-aid equipment, and train qualified first-aiders.

WHY

Farms and fields are often distant from villages and communities. When farmers are injured at work, they need immediate first-aid treatment. First-aid equipment must be provided near the workplace.

If farmers have the appropriate training, they can become qualified first-aiders. They can potentially save many neighbouring farmers when they are seriously injured. Appropriate first-aid treatment is essential before injured farmers are transferred to the nearest health care facility or hospital.

HOW

1. Prepare an easy-to-carry first-aid kit for mobile work or work in the field.
2. Put different groups of drugs and equipment in separate compartments of the first-aid kit. This is helpful for emergency treatment. To treat injuries, the kit should include items such as sterile cotton, gauzes, alcohol, bandages, dressings, eyewash fluid, scissors and antiseptic. The contents of the kit should meet the requirements of workplace safety and health regulations, and be appropriate to the types of injury that are likely to occur at the workplace.
3. Position the first-aid kit out of the reach of children. Paint the kit box in a light colour, to distinguish it clearly from other boxes.
4. Participate in the first-aid training organized by clinics and hospitals. Exchange experiences with other farmers.

WAYS TO PROMOTE COOPERATION

Help each other by giving some medicine or medical equipment to your neighbours and friends when necessary. Some urgent cases might even occur at night time. Exchange ideas on how to improve the contents of first-aid kits, and maintain them in good condition.

SOME MORE HINTS

- Clearly label all bottles of drugs to avoid mistakes.
- Regularly check the expiry dates of drugs. Discard those that are out of date, or have deteriorated as a result of improper storage. Cork drug bottles well for good maintenance.
- Learn from experienced persons in your community about the use of local medicinal herbs to prevent and treat commonly seen indispositions, minor diseases and injuries among farmers. Pick from the wild, or grow on your land, medicinal herbs that have been proven to be effective by local experience.

POINTS TO REMEMBER

Well-equipped and maintained first-aid kits, and some basic health knowledge, will help you, your family members and your neighbours in an emergency.

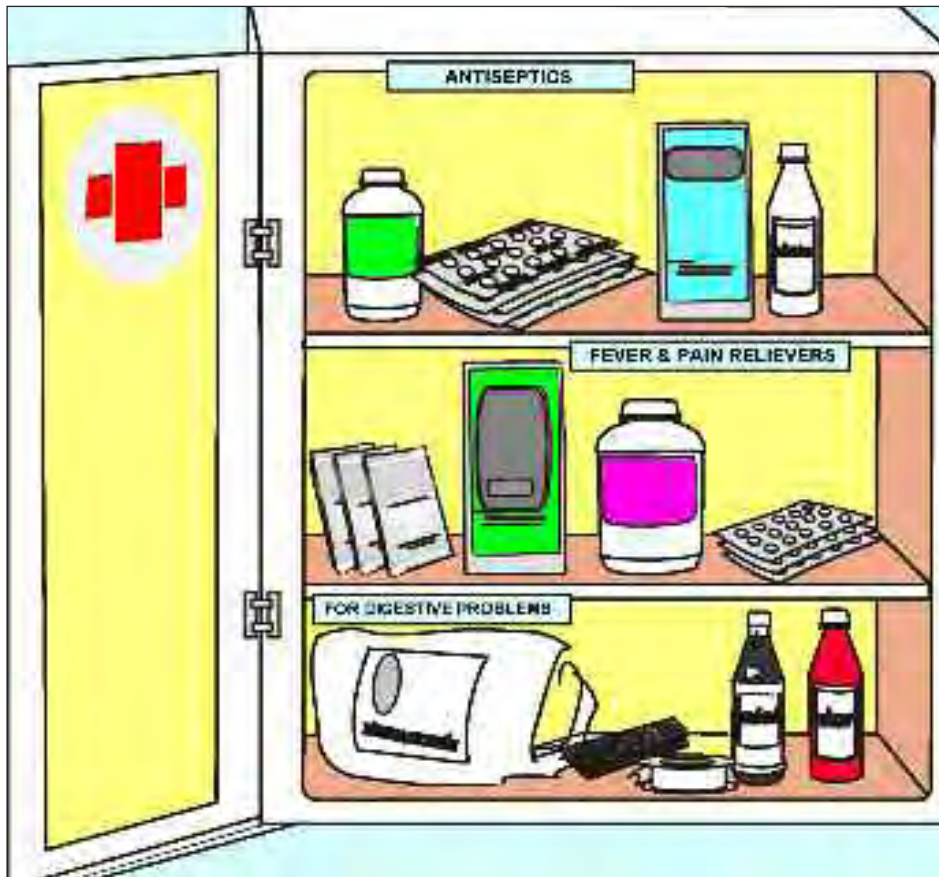

Figure 75a. A drugs kit with different compartments for related drugs and equipment. Stick a clear label or sign on the door to avoid misunderstanding.

Figure 75b. A first-aid drugs kit painted a light colour and hung out of reach of children.



Figure 75c. A family medicinal herb garden.



CHECKPOINT 76

Keep children away from machines and hazardous chemicals.

WHY

Children play with their friends in the field. Busy parents working on the farm cannot keep watching their children all the time. Children don't know the danger of machines, or of exposure to pesticides and other hazardous agents. You need to take practical measures to keep them away from these dangers.

Older children will understand dangers. Teach them how to stay away from dangers, and how to protect themselves from accidents and diseases. They can contribute to increasing the awareness of your community on safety and health, both at work and at home.

HOW

1. Place appropriate barriers around dangerous places and facilities to prevent children from having accidents.
2. Switch off all machines when you are not using them. Ensure the machines don't start accidentally if children happen to touch them.
3. Children may come into the fields or onto the farm. Check for potential dangers such as machines, slippery paths or exposure to pesticides in the workplace, and keep children away from such dangers.
4. Keep pesticide bottles and containers, including used ones, in designated areas where children cannot reach them.

WAYS TO PROMOTE COOPERATION

Children and babies need special attention for their safety. Discuss the possible dangers and the protective measures with your family. Share the roles and responsibilities among family members to protect children. Collect good examples of the safety and health protection of children from your neighbours, and apply them to your own family.

SOME MORE HINTS

- Establish neighbourhood kindergartens and childcare centres to keep children in a safe and healthy place.
- Use clearly visible colours such as yellow or red for children's clothes, to help prevent traffic or machine accidents.
- If children touch pesticides or other chemicals, take them to the washing facilities to wash them off.

POINTS TO REMEMBER

Keep your children safe and healthy, and protect them from dangers in the working and living environment.



Figure 76a. Children play safely in a wooden play-pen.



Figure 76b. Safety frame to keep children inside the house. The frame is removable for ease of access.



Figure 76c. Use locally available materials such as bamboo and hibiscus to build gates and fences so that children can be kept safely inside.

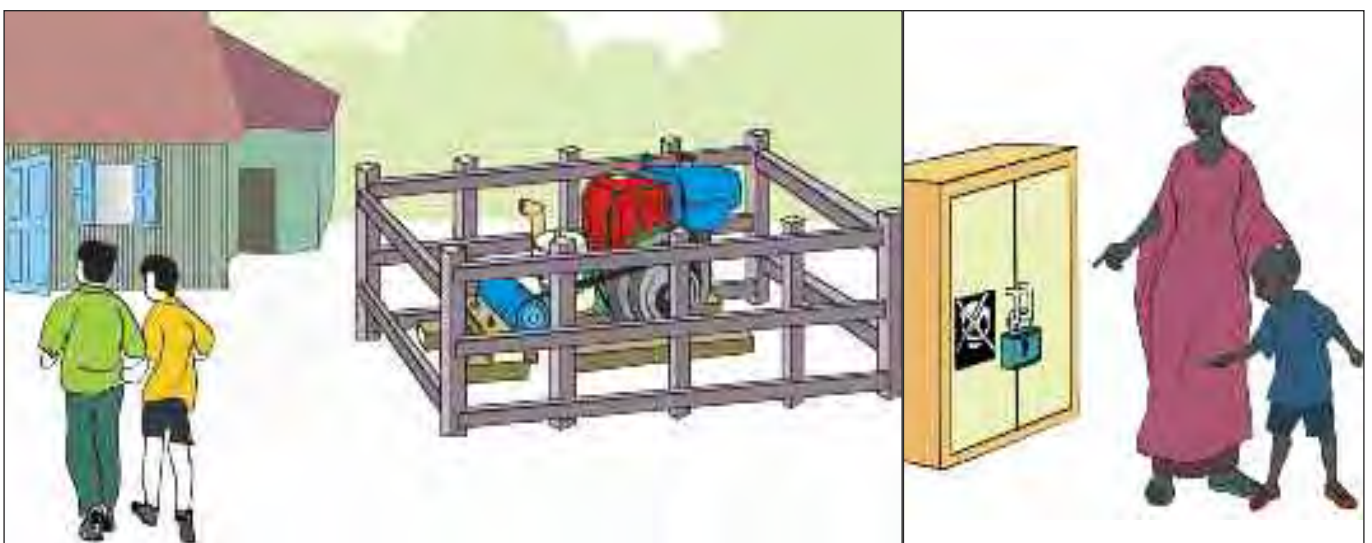

Figure 76d. Keep children away from machines and chemicals.

CHECKPOINT 77

Provide rest areas near farm fields, shaded from the sun.

WHY

Farmers spend a considerable part of their working life in the field. As at home, they also need to rest, relax, refresh themselves and eat in order to recover from fatigue and keep in good health. Workplaces and homes are often some distance apart. Rest areas and facilities on the farm and in the field facilitate recovery from fatigue. Similarly at home, facilities for resting and relaxing help farmers to refresh themselves and recover from fatigue.

HOW

1. Build a rest facility near your work in the field. A simple small shelter will meet the purpose. You can use available local materials such as palm thatches for construction. Equip the rest facility with a hammock, mat or bed for lying down.
2. Create a pleasant environment for your comfort. You might want to install pictures or other decorations on the wall of your rest facility, and plant trees and flowers around it outside.
3. For indoor agricultural work, you might install simple relaxation facilities, such as reclining chairs, hammocks or benches.
4. Share rest areas and facilities, with your neighbouring farmers.

WAYS TO PROMOTE COOPERATION

Resting means recovery. Share with your neighbours good environments and habits for resting. Cooperate with your neighbours to build a rest facility at the farm or near the field, and use it together. Pleasant resting environments also facilitate good communications with your neighbours.

SOME MORE HINTS

- Choose a dry and shady place for the rest area when there is no hindrance to natural flow of air in hot weather, or a dry and sunny place that is protected from cold winds.
- You might develop temporary rest areas in different places to meet your needs, for example for the busy harvest season. Or you might make it permanent if you can use it for other purposes during the seasons when you don't need it for resting, for example to keep tools and equipment together.
- A good view from the rest area will make the resting and recovery from fatigue pleasant.

POINTS TO REMEMBER

Rest facilities in the workplace and at home facilitate recovery from fatigue, and help you and your family maintain good health.



Figure 77a. Resting means recovery. Share good rest environments and habits with your neighbours.



Figure 77b. Provide rest chairs for relaxation after a hard working day.



Figure 77c. Provide relaxation facilities at home.

CHECKPOINT 78

Provide recreational facilities.

WHY

Recreational facilities have multiple, positive effects for farmers. After a day's hard work, some sport or game activities may refresh the mood of farmers. Adequate sports will help you use parts of your body and muscles which may not be used during your agricultural work. This is good for your health.

Recreational facilities can help create good relationships among neighbouring farmers, which are the basis for productive cooperation. Sporting activities can help develop farmers' teamwork. A village team can enjoy sporting competition with other village teams. These exchanges will increase useful communication among neighbouring farmers for future collaboration.

HOW

1. Identify the recreational facilities that you or your neighbours need. Some may select sport; others may prefer games. Discuss this with your friends.
2. Find a place to site the recreational facilities, and build them. If they are located in the community space of your village, they will be built as community property. More people will be able to use them.
3. Promote the use of the established recreational facilities. Lunch breaks, and after work, are the times when they will normally be used.

WAYS TO PROMOTE COOPERATION

Find out what sports and recreational facilities are available in your community. Examine jointly with your neighbours whether you can get the support of local agencies and other community organizations in expanding or improving the existing facilities.

SOME MORE HINTS

- Build simple sports or games facilities as a first step, and then gradually expand them. You may be able to learn from the recreational facilities that exist in neighbouring villages.
- Use the established recreational facilities as community property. Organize sports or games events on holidays to strengthen community collaboration. Have fun with your neighbours.
- Have proper furniture and equipment, such as a television, sofa and coffee table, to make people feel comfortable in the recreation room.

POINTS TO REMEMBER

Recreational facilities in your village or community will promote your health and community collaboration.



Figure 78a. Recreational activities help to create good relations with your neighbours.



Figure 78b. Proper furniture and equipment, such as a television, sofa and coffee table, will make people feel comfortable in the recreation room.

CHECKPOINT 79

To ensure good nutrition, eat a variety of foodstuffs, such as different kinds of meat, fish and vegetables.

WHY

To maintain your health, well-balanced meals consisting of a variety of ingredients such as meats, fishes, vegetables and fruits are essential. Good meals will protect you against fatigue and disease as well as providing energy for you to work.

Even during busy working periods, such as harvesting, you should maintain good eating habits. Repeatedly eating only one type of food will adversely affect your health. Try your best to ensure you have a variety of foods, to ensure intake of the necessary nutrition.

HOW

1. Balance your nutritional requirements, such as proteins, carbohydrates and vitamins.
2. Check what locally available and popular foodstuffs you can easily obtain. From your farms, or from nearby villages, there must be a variety of foods containing different nutrition.
3. Your meals should include as much variety of foodstuffs as possible, including meat, fish, vegetables and fruit.
4. Ensure you eat breakfast before going to work. Take a lunch box to the farm or the field if they are far from your house, or eat lunch in the dining room of the workplace. If your house is close to the farm, you can come home for lunch. After work, prepare a good dinner at home.
5. You could build a fish pond, and plant vegetables and fruits, to secure different kinds of nutritious food sources.
6. Cultural and religious considerations need to be taken into account.

WAYS TO PROMOTE COOPERATION

Eat lunch with your neighbours on the farm or in the field. This provides a pleasant opportunity to exchange information on cropping. You can also share delicious and nutritious foods with your neighbours, and learn new methods of cooking healthy foods. Enjoy the chance to talk with your neighbours after work.

SOME MORE HINTS

- Choose a pleasant place for lunch near the farm or the field. The place needs shade. You might choose a place under a big tree. Alternatively, you could build a hut near the farm for eating and resting.
- Cooking is fun! Share the roles of cooking. Men and women can share the pleasure of cooking and preparing healthy foods.

POINTS TO REMEMBER

Having regular and nutritious meals prevents fatigue, minimizes the risk of errors and accidents, and increases productivity.



Figure 79a. Have a variety of nutritious foods for meals.



Figure 79b. Share lunch with your neighbours when working in the field.



Figure 79c. Have regular nutritious meals with your family.

CHECKPOINT 80

Maintain a comfortable sleep environment for recovering from fatigue.

WHY

Farmers require sufficient, good-quality sleep every night to recover from fatigue. Establishing a regular sleep habit is the basis for good health and productive work. A long sleep in one day cannot compensate for a lack of sleep in another day. Farm workers with sleep deficiencies will increase accident risks.

To ensure quality sleep, take care to maintain a comfortable sleep environment: one that is quiet, neither hot nor cold, free from bad odours or dusts, and with appropriate humidity (i.e. neither too wet nor too dry).

HOW

1. Choose a quiet corner in your house as your bedroom. Ensure good ventilation to avoid excessive heat. In winter, prevent cold outside air from coming into your sleeping room.
2. Prepare a safe, stable bed that will not wobble or make a noise. Sleeping facilities should be maintained in good, sanitary condition and should be free from dirt, bad smells and insects.
3. In the daytime, your bedroom should be cleaned regularly, and ventilated with fresh air from outside.
4. Blankets, pillows and bed covers should be regularly washed and dried in the sun.

WAYS TO PROMOTE COOPERATION

The daily life in your community has its own rhythm. This established rhythm usually has favourable effects on your own daily rhythm. Exchange experiences with your neighbours on maintaining a good sleeping environment. There may be some good examples of improving the sleeping environment.

SOME MORE HINTS

- Establish a regular sleep habit. You need around 8 hours of quality sleep at night to ensure your health and alertness during the working day.
- Farmers often start their work early in the morning. To ensure sufficient length of sleep, avoid working or eating late.
- A 15–30 minute nap after lunch refreshes farm workers, and eliminates drowsiness in the afternoon. It is good to prepare a comfortable place for napping.
- Taking alcohol before sleep is not recommended. Excessive alcohol will lower the quality of sleep.

POINTS TO REMEMBER

Quality sleep at night is the basis for good health and productive work in the daytime.



Figure 80a. Follow local customs that help you relax in a good atmosphere.



Figure 80b. Keep your sleeping environment clean and comfortable.



Figure 80c. During the daytime, clean your bedroom regularly and let in fresh air from outside.

Family and community cooperation

In agriculture, farmers and family members cooperate closely, not only in everyday life but also in arranging various kinds of farming task. Sharing of agricultural and household work is an important aspect of this close cooperation. Special care for pregnant women, elderly farmers and those with disabilities also requires the whole family's cooperation. Further, joint group activities with other households in the community are essential in organizing many seasonal farming tasks. Joint investment plans, regular meetings and recreational activities help improve the safety, health and well-being of farmers in the community. This chapter presents many practical ideas to enhance family and community cooperation in these various aspects of agricultural work life.

CHECKPOINT 81

Organize group work activities for performing strenuous tasks with the help of experienced leaders.

WHY

Farmers have to do a variety of strenuous tasks that it is difficult to carry out alone: for example, building farm roads, bridges and houses; digging wells and canals; harvesting the crops and doing heavy work on the farm; or moving heavy machines. Working in a group is the solution to perform these strenuous tasks. Group activities provide good opportunities to strengthen farmers' cooperation.

Performing these strenuous tasks requires good plans and special skills. Farmers need experienced leaders to organize and carry out these tasks safely and efficiently. Cooperation among farmers under the experienced leaders will ensure good outputs, too.

HOW

1. Identify strenuous tasks that need the cooperation of many farmers.
2. Organize group activities to plan and perform the identified strenuous tasks.
3. Assess the safety and health risks associated with the tasks, such as working at height, carrying heavy materials or the use of dangerous machines. Ensure measures are put in place to prevent accidents and injuries.

WAYS TO PROMOTE COOPERATION

Ask the most experienced, skilled farmer to lead the organization of other farmers for carrying out the tasks safely and efficiently. Monitor and evaluate the progress of these tasks. Assess the safety and health risks when new work methods and procedures are introduced.

SOME MORE HINTS

- Ask for technical support from the local government units or local technical institutions when the task includes technical or safety problems that farmers cannot solve alone.

- Experience of group work activities for performing strenuous tasks will strengthen farmers' mutual cooperation. The experience can be extended to a variety of agricultural jobs, such as sharing seeds and new methods for growing crops, or saving money to purchase or hire costly agricultural machines.

POINTS TO REMEMBER

Performing strenuous tasks needs cooperation among farmers. Jointly plan and prepare the necessary safety and health measures.



Figure 81a. Organize group activities for performing strenuous tasks with the help of experienced leaders.



Figure 81b. Join others in work to repair the community's roads.



Figure 81c. Strenuous tasks require the cooperation of many people.

CHECKPOINT 82

Share the roles of agricultural and household work, and avoid overburdening any one family member.

WHY

Farmers and their families need to carry out both farm and household tasks. It is important that every family adult member, both men and women, shares family roles and responsibilities as well as their farm work, depending on their physical capacity, skills and experience. This will avoid overburdening a particular family member. Men and women can share household tasks and family responsibilities.

Every adult family member needs to know and participate in various family jobs, such as cooking, washing, child care and cleaning. Participation will provide new insights into their work in family life and fun. Family members can learn from each other, which will consolidate their ties.

HOW

1. Review the work sharing in your family. Make efforts to share farm work and household work.
2. Discuss with your family members whether any of them shoulders too many responsibilities. It is useful to know who is over-fatigued, or has muscle strains caused by a heavy workload.
3. Exchange ideas on how to share roles in both farming and household tasks.

WAYS TO PROMOTE COOPERATION

Let family members play a variety of roles, depending on their physical capacities, rather than fix each person's role based on their gender. Continue discussions in the family about role sharing, and change roles flexibly when opportunities arise.

SOME MORE HINTS

- In community meetings, people can exchange experiences of sharing family responsibilities and of happy family life. Learn from good examples that avoid overburdening a particular family member. Always encourage male adult members to do household work, and share family responsibilities between men and women.
- Family and household jobs are continuous from morning until night, and it is often difficult to insert sufficient breaks. The work continues even during holidays. Help each other and share responsibilities, to ensure the necessary rest periods for all.
- Prepare for busy work periods such as the harvesting season. Consider temporary support from your neighbours, or even farmers outside your community, to avoid overburdening family members. Some household work, such as preparing food, can be done together with neighbours.

POINTS TO REMEMBER

Sharing family responsibilities increases your family harmony and improves work productivity.



Figure 82a. Share household work; cook meals together.



Figure 82b. All family members contribute to farming.

CHECKPOINT 83

Make joint investment plans to buy or hire costly machines and equipment.

WHY

Farmers use machines, vehicles and equipment to increase productivity and reduce workload. They are costly, and a single farmer family often faces difficulties in buying them. Many agricultural machines are used only during limited periods of the agricultural production process. For instance, seeders or seedling-planting machines are used only during the sowing season, and harvesting machines are used only during the harvesting season.

Neighbouring farmers can make joint investments to purchase, use and maintain machines and equipment. The joint purchase will help individual farmer families save money, increase the efficient use of the machines, improve productivity and reduce farmers' workload. This is also an opportunity to have high-quality machines and equipment that are too expensive for a single farmer family to buy. Farmers who invest jointly will have shared responsibilities to ensure the safety and health aspects of operating the machines and equipment.

HOW

1. Review your work. Find which machines and equipment could make your work easier, safer and more productive. Consult your neighbours who have these machines.
2. Make joint plans to purchase costly machines together with your neighbours who have the same need.
3. Visit agricultural machinery suppliers to see the machines and equipment you would like to have, and check the prices. Identify quality machines and equipment that are durable and safe.

WAYS TO PROMOTE COOPERATION

Discuss with your neighbours or farmer friends about the way to buy machines and equipment jointly. Agree joint maintenance plans with them, as well as joint investment plans.

SOME MORE HINTS

- Learn from farmers who already have experience of joint investment in buying costly machines and equipment.
- Farmers' associations and cooperatives may help you find your joint investors, if you cannot find them by yourself. They can assist you in making practical investment plans for buying machines.
- Make a joint management and maintenance plan together with your investment partners. Discuss where the machine should be kept, and who should regularly maintain and fix it, or how to share the cost of maintenance and repair.
- Buy a safe, good-quality machine, and together with your investment partners learn how to use it safely and productively.

POINTS TO REMEMBER

You and your neighbours can together buy and use costly machines for higher productivity and reduced workload.



Figure 83a. Visit agricultural machinery suppliers together with your neighbours, and examine the types of machine that will suit your work.



Figure 83b. Discuss with neighbouring farmers which machines and equipment would be useful, and formulate joint investment plans.

CHECKPOINT 84

Hold regular meetings or group activities involving neighbours, and use such occasions to review safety and health aspects.

WHY

There are many ways in which neighbouring farmers can cooperate to improve farming work: for example, in introducing new farm products, applying new production methods, or selling their products together. Regular meetings greatly help you exchange information and experiences.

Safety and health aspects should be a central agenda item in farmers' meetings. Farmers, through exchanging experience, will be better able to identify and improve their safety and health risks. There are many low-cost ways in which safety and health risks can be reduced, and the resulting improvement of working conditions will contribute to work efficiency and economic success.

HOW

1. Choose the place where your neighbouring farmers gather to meet. Organize your meetings at a time that is convenient for most people at this place.
2. It is important to make the meetings both practical and interesting. Select discussion topics that reflect the immediate needs of farmers, such as new production methods, joint marketing of agricultural products or ways to improve productivity.
3. Exchange practical improvement experiences in safety and health.
4. Learn from practical improvements already implemented by your neighbouring farmers in materials handling, work posture, machine and electrical safety, the handling of pesticides, physical environmental factors such as heat, cold, noise and dust, and welfare facilities.

WAYS TO PROMOTE COOPERATION

Discuss practical ways to improve work layout and procedures. Simple layout changes, such as the distance over which materials have to be carried, can often dramatically reduce workload and improve work efficiency. Examine how neighbours cooperate in improving the layout and procedures together. Include work-related welfare facilities such as toilets or rest areas in the discussion. Farmers may be able to build these facilities for joint use.

SOME MORE HINTS

- Meetings should not be long. Prepare practical agenda items in order to produce concrete results and action plans.
- Make follow-up plans to implement the results of the meeting discussion. Clarify who should do what, and by when.
- Promote equal participation by men and women, young and elderly, itinerant and migrant farmers to hear their concerns and opinions.

POINTS TO REMEMBER

Regular meetings among farmers are practical opportunities to improve the quality of working life.



Figure 84a. Review the safety and health aspects of your farming work together with your neighbours.



Figure 84b. Examine jointly with your neighbours and community leaders safety and health risks in the use of agricultural machines.

CHECKPOINT 85

Take special care of pregnant women.

WHY

Many women are actively engaged in agricultural work. During pregnancy, they need special care. Pregnant women farmers don't have to avoid work completely during the whole pregnancy period, but should avoid hard work, work that requires excessive force, working in bad postures, exposure to chemicals, or long hours of work or night work.

Practical actions should be taken to make their work easier, and to suit their special needs. Adjusted work methods can improve both the safety and the efficiency of their work.

HOW

1. Don't assign pregnant women to carry out work that requires a lot of strength, such as lifting or carrying heavy objects. This is especially important at the beginning and in the last months of pregnancy. Neighbourhood and family cooperation is essential for improvement.
2. Allocate light work with comfortable postures for pregnant women when they are required to work. Provide sitting facilities for pregnant women, and insert frequent rest pauses during work.
3. Discuss with pregnant farmers their special needs. Observe their working conditions to identify possible improvements. Practical measures designed to support pregnant farmers will allow them to work safely and efficiently. Often simple solutions work very well.

WAYS TO PROMOTE COOPERATION

Collect examples in your community of good working conditions adjusted to the special needs of pregnant women. Work together to implement improvements. For example, improved routes and workstations help pregnant farmers move freely and work comfortably. Neighbourhood cooperation is essential.

SOME MORE HINTS

- Adjust basic welfare facilities, such as the provision of drinking water, rest areas and toilets, according to the practical needs of pregnant farmers.

POINTS TO REMEMBER

Providing a work-friendly environment for pregnant women helps them overcome the difficulties of their pregnancy.



Figure 85a. Provide a good and suitable seat for a pregnant woman when she takes part in work.



Figure 85b. Provide a comfortable resting chair for a pregnant woman in the family.

CHECKPOINT 86

Provide support for elderly farmers so that they can work safely.

WHY

Elderly farmers are experienced farmers. They have experience in agricultural production methods and procedures suited to the local situations. Adjusting the working conditions and work organization of elderly farmers to reduce their workload can increase their productivity.

Elderly farmers can help other farmers in many ways, for example by providing advice and supervising younger, less experienced farmers.

HOW

1. Check together with elderly farmers their working conditions, to determine whether the tasks they do are causing difficulties for them. Discuss how these tasks can be adapted to suit elderly farmers.
2. Apply mechanical devices for physically demanding tasks involving elderly farmers, such as carrying heavy agricultural products. Make sure that they are able to accomplish their tasks safely.
3. Make instructions, signs and labels easy for elderly farmers to read by using large letters.
4. Provide sufficient lighting for elderly farmers when they are engaged in in-house work, for example packaging agricultural products. Install local lights, if necessary.
5. Make the pace of work variable between younger and elderly farmers, so that elderly farmers can cope more easily with it.

WAYS TO PROMOTE COOPERATION

When introducing new production technologies, consult elderly farmers to see what measures need to be adopted for both younger and elderly farmers. Group work in which farmers can help each other while the pace of work may vary between individuals is a good solution to solve the difficulties that elderly farmers may have.

SOME MORE HINTS

- Pay attention to the special needs of elderly farmers. Their skills and experience are helpful for younger farmers. Simple solutions, such as avoiding heavy materials handling, and providing clear passageways, or appropriate lighting for easy reading, greatly help elderly farmers.
- In addition to mechanization, there are other measures to make tasks physically easier. For example, improving materials handling can greatly help elderly farmers.
- Train elderly farmers in new tasks in a way that is suited to them.
- Provide opportunities for elderly farmers to share their work experience with younger farmers, and advise them how to work efficiently and safely.

POINTS TO REMEMBER

Make full use of elderly farmers' knowledge and experience by adapting working conditions to suit them. Jobs friendly to elderly workers are jobs friendly to all.



Figure 86a. Provide sufficient lighting for elderly farmers when they are engaged in in-house work.



Figure 86b. Use larger letters for labelling switches and displays so that elderly workers can read them easily.



Figure 86c. Provide elderly workers with opportunities to do hobbies and recreational activities, and help them share their experiences in farming.

CHECKPOINT 87

Adapt facilities and equipment for farmers with disabilities so that they can do their work safely and efficiently.

WHY

Farmers with disabilities can work safely and efficiently if adequate support is provided to meet their needs.

The needs of farmers with disabilities vary from individual to individual. Some needs can be met by making the equipment and tasks more user-friendly, but there are other individual needs that can be addressed by paying close attention to their limitations.

The best way to meet these needs is to observe carefully the working conditions and tasks of farmers with disabilities. Organizing group discussions on improvement of the workplace, and adapting the working tasks to accommodate their disabilities, will increase their safety and productivity.

HOW

1. Visit farms and agricultural workplaces where farmers with disabilities are working. Discuss with them what they need to make their work easier and safer.
2. Organize group discussions about how to meet the specific needs of disabled farmers. Keep in mind that user-friendly measures can help in general, but that there are also individual needs to be considered.
3. Consider not only easy access and use of work equipment, but also easy access to workplace welfare facilities for all farmers in general, such as entering workplaces, access to recreation places and use of toilets.
4. Find existing good examples that help farmers with disabilities work safely and efficiently.

WAYS TO PROMOTE COOPERATION

Organize adequate training on adaptation of working conditions to meet the needs of farmers with disabilities, and on their fellow farm workers' cooperation and support to create an enabling working environment for farmers with disabilities.

SOME MORE HINTS

- Promote the sharing of work experiences of farmers with disabilities with other farmers, so that other farmers can receive practical ideas to help and improve their work methods and procedures to meet the working needs of persons with disabilities.
- Collect good examples of how farmers work together with disabled farmers as a team. These examples will provide good models of how they share their agricultural work tasks in a safe and efficient manner.
- Flexible work organization and working time may be particularly needed for farmers with disabilities. Discuss possible options in group meetings to find practical solutions.

POINTS TO REMEMBER

By providing adequate support for farmers with disabilities, they can work safely and efficiently. Organize group discussion involving them and other farmers.



Figure 87a. Allocate comfortable, easy tasks, and provide an appropriate workplace for farmers with disabilities.



Figure 87b. Provide workstations suited for workers in wheelchairs and other workers with disabilities, so that they can work smoothly and comfortably.



Figure 87c. Rearrange the workplace layout and materials handling for workers with disabilities.

CHECKPOINT 88

Organize group physical exercise, and create health clubs in the community.

WHY

Regular physical exercise is a good way of maintaining your physical fitness and capacities, and facilitating recovery from farming work fatigue. Physical exercise in rest periods also help you refresh yourself. It is useful to organize regular physical exercise in groups, as people are more likely to keep the habit if they do the physical exercises together.

Improving your physical fitness helps greatly in maintaining your working ability for agricultural tasks. Fatigue from work is reduced, and recovery is quicker. Joint activities with your neighbours or in health clubs will help you take physical exercise in a regular and habitual manner.

HOW

1. Learn appropriate kinds of physical exercise for farmers from agents conducting group physical exercises, or from books or television programmes.
2. Discuss with your neighbours and community leaders the organization of joint physical exercises. Find appropriate facilitators who have experience in selecting suitable physical exercises and conducting group exercises.
3. Conduct group physical exercises for a predetermined period, or regularly at fixed times. Make plans for alternative exercise programmes if the weather is bad.
4. Create a health club for group physical exercises or sport activities. It is always advisable to learn from the experiences of existing health clubs. Make plans to utilize playgrounds, gyms or fitness facilities.

WAYS TO PROMOTE COOPERATION

Learn from existing group activities in your community, or a neighbouring community, for conducting regular physical exercises. You will easily see the benefits of group exercises. Discuss with your neighbours, or with people interested in having a health club, the types of exercise or sport activity that will be more appropriate for local farmers, and will have a lasting benefit. If appropriate, organize trial sessions of such physical exercises or sport events.

SOME MORE HINTS

- Regularly insert a short period of physical exercise before starting farming work, or during short breaks. Choose appropriate types of exercise that people can easily do together.
- Ask a physical exercise trainer in your vicinity to organize regular sessions of physical exercise at available facilities and encourage people to join regularly. Regular group physical exercise can be fun.

POINTS TO REMEMBER

Group physical exercise helps maintain your physical fitness, and facilitates a collaborative spirit among neighbouring farmers.



Figure 88a. Create regular opportunities for conducting group physical exercise. Use a break for these exercises, and try to do them regularly.



Figure 88b. Consult health clubs in the community for types of physical exercise and recreational activity suitable for local farmers.

Work organization and working schedules

Farming work consists of a large variety of tasks. These are done in a serial manner, in accordance with soil preparation, planting and cultivation, harvesting and handling farm products. It also involves managing households. These serial tasks are often combined, as multiple crops are cultivated at the same time. It is important to organize work tasks in advance, and to manage group work at the various stages. Good teamwork and well-planned work schedules are essential. Suggestions for improving work organization and working schedules are given in this chapter. Attention is drawn to improving work plans and teamwork, sharing work, sufficient rest periods and a smooth flow of work.

CHECKPOINT 89

Combine tasks so that each worker can perform varied and interesting work.

WHY

Farmers often have to do repetitive and monotonous tasks, such as planting and harvesting, or sorting and packaging agricultural products. Repetition of the same monotonous tasks and a lack of variety cause boredom and fatigue. When doing one job repetitively, only the same group of muscles is used, and the same work posture continues. This results in local muscular fatigue, pains, or even injuries. Work efficiency will be lowered. Frequent changes in tasks are therefore needed.

Monotony can cause the attention to wander. This can easily lead to low-quality work, and even to accidents. Monotony must be avoided to keep farmers alert and productive.

Performing various different tasks prepares farmers for multiple skills. Multi-skilled workers are more productive, and better able to organize a productive flow of work.

HOW

1. Do agricultural work by combining two or more tasks. Provide the necessary changes in workstations and tools.
2. Combine a series of tasks so that the cycle time per worker becomes longer.
3. Allow rotation of jobs within a certain number of workers, so that each worker can have frequent changes of tasks.
4. Train workers for adequately performing new and combined tasks.

WAYS TO PROMOTE COOPERATION

Arrange for autonomous work groups. In each group, several workers share joint responsibility for performing the combined tasks and conduct serial work. Discuss suitable ways to sustain these work groups, taking into account recent experiences of joint farming work in busy seasons.

SOME MORE HINTS

- Provide workstations that the same worker can use for performing multiple tasks, and which can also be used by different workers.
- When doing combined tasks, provide opportunities for workers to walk around or change from sitting to standing, or from standing to sitting.

POINTS TO REMEMBER

Combining tasks to avoid monotony and make the work more interesting improves productivity.



Figure 89. Allocating two or more tasks to one farm worker makes their work more interesting.

CHECKPOINT 90

Record accidents, and discuss improvement measures by analysing them.

WHY

Recording accidents helps farmers know the main causes of accidents and plan necessary improvements. These records provide useful information about why accidents occur, and what needs to be done to improve the existing conditions.

It is equally important to keep records of health conditions, sickness or discomfort of yourself, your family members and your neighbouring farmers. For example, farmers with serious low-back pain may often be absent from their work. This type of chronic illness would not be known if only accident records are kept. Some general symptoms of discomfort, such as chronic fatigue and headache, might be signs of chronic pesticide poisoning.

HOW

1. Record all accidents, absences, sickness and other health-related events, and report them if required by occupational safety and health regulations.
2. Find the causes of the accidents and diseases, and improve your working conditions by taking effective prevention and protection measures.
3. Keep records of accidents, diseases and absence, and analyse the trends of their occurrence over time to evaluate the effectiveness of the control measures.
4. Get help from occupational safety and health professionals in assessing and controlling the risks at your workplace.
5. Protect the privacy of each farmer participating in the accident recording. Don't disclose the names of those with injury or disease to others except the doctors treating them.

WAYS TO PROMOTE COOPERATION

Keeping accident records requires the continued cooperation of all people concerned with reporting, completing report forms, keeping statistics and analysing the accident data. Try to publicize the most recent accidents and the results of analysing why they occurred. This will help encourage immediate reporting of accidents using the report forms.

SOME MORE HINTS

- When analysing the records, try to find practical ways to prevent accidents by providing a safe environment, rather than determining who is to blame.
- Work-related accidents, sickness and absences are enemies of productivity. Accident records and absence records provide useful information for improving working conditions and reducing the risk of accidents.

POINTS TO REMEMBER

Recording and analysing accidents, sickness and absences gives farmers practical information to prevent work-related accidents and diseases.



Figure 90a. Record accidents using a simple report form, and use a file or a book to contain the collected reports.



Figure 90b. Analyse the causes of injuries or illnesses related to work, and discuss how to prevent similar problems in the future.

CHECKPOINT 91

Rearrange the layout and the order of operations to ensure a smooth flow of work between different worksites.

WHY

Good work layout always avoids unnecessary repetition and movement of farmers. For example, it minimizes the total distance required for carrying materials and products from one worksite to another. It thus allows farmers to work smoothly and comfortably. Farmers can work with less physical effort, and a reduced risk of injury.

A smooth workflow will provide farmers with a stress-free work environment, and maximize the benefits of teamwork. There are many ways to improve the production layout and the order of operations to make the workflow smoother.

HOW

1. Arrange the overall production layout to allow each farmer to accomplish the assigned work without unnecessary movement.
2. Adjust the height differences within each workstation and between different workstations in order to achieve a smooth flow of materials, products and semi-products.
3. Find worksites where farmers have to move many times when carrying materials and devise a better layout to avoid such movements.
4. Plan and try to implement simple layout changes in collaboration with other farmers. For example, if farmers often have to walk a long distance between two worksites, relocate the worksites nearer to each other.

WAYS TO PROMOTE COOPERATION

Discuss with neighbours and family members ways to reduce movements during joint farming work. Farmers can take the initiative in redesigning transport means and appropriate workstations by minimizing height gaps and distances between workstations for smooth workflow.

SOME MORE HINTS

- Conduct a joint walk-through in your worksites with other farmers, and identify layout changes that can be easily implemented. Simple layout changes can often increase productivity without additional costs. Removing farmers' unnecessary movements by layout changes will greatly improve the production flow, and minimize lost time and product damage.

POINTS TO REMEMBER

Simple changes of the layout, or of the order of production, can reduce farmers' physical stress and promote a smoother workflow.

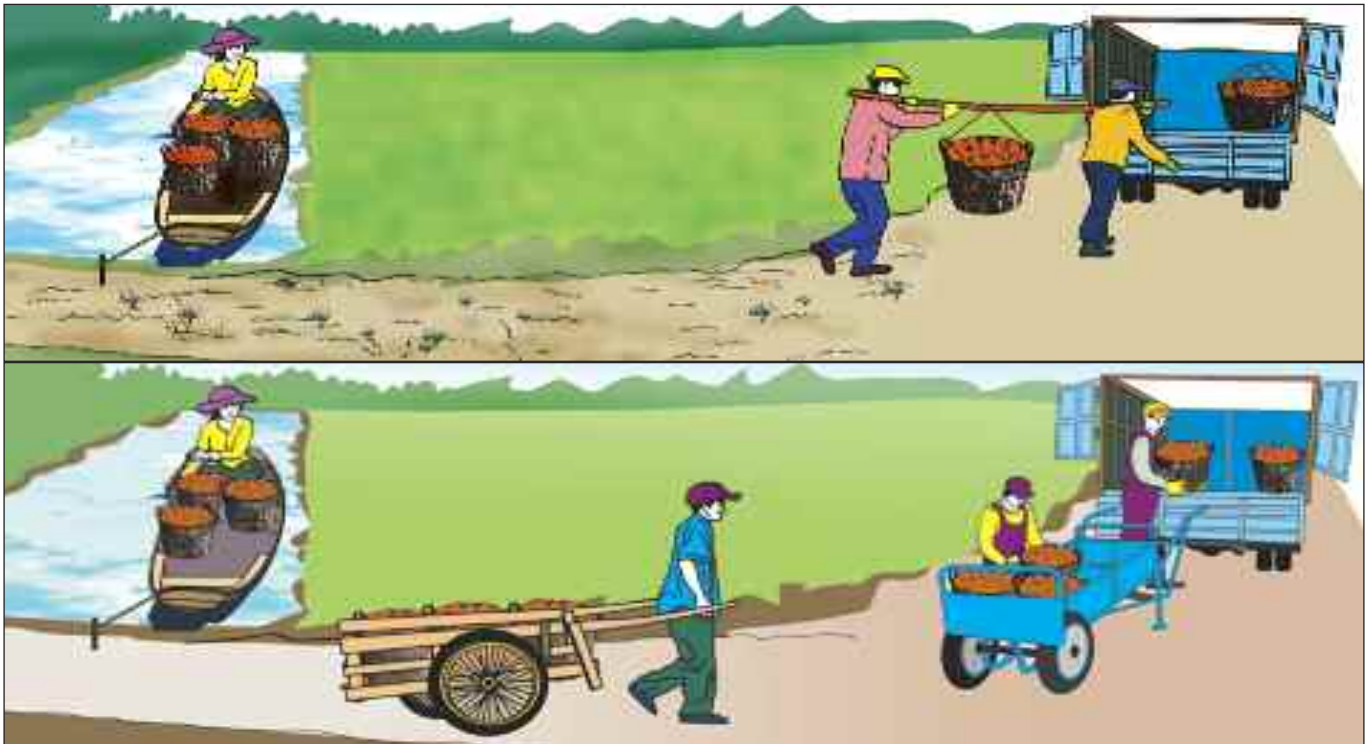

Figure 91a. Simple changes in working methods can reduce workload.



Figure 91b. An improved workflow can reduce accidents.

CHECKPOINT 92

Organize appropriate rotation of tasks or teamwork to avoid excessive machine-paced work.

WHY

Farmers use machines for sorting and packaging agricultural products. Often, they have to work at the speed of the machine, and repeat monotonous and repetitive tasks. This can cause fatigue and low productivity.

Rotating tasks in a work team can reduce these risks. Many farmers find it beneficial to assign work to groups instead of to individuals. This is because work groups are more productive, with much less unnecessary work and fewer mistakes.

Using group work arrangements, it is easier and less time-consuming to avoid excessive machine-paced work. The work flows more smoothly.

HOW

1. Look at your farm and worksites to see whether there is excessive machine-paced work. Explore the possibility of reducing this by rotating tasks, or through teamwork.
2. Organize an appropriate rotation of tasks. Find a group of tasks that farmers can perform in rotation. Devise and implement a plan to rotate the tasks among the participating farmers during the working day, or over several days.
3. Form a work team so that the team members can regularly change tasks to avoid excessive machine-paced work.

WAYS TO PROMOTE COOPERATION

Rotation of tasks among farmers should be well planned. The duration of each designated task should be agreed on by the participating farmers. After trying the initial rotation plan, discuss how to rotate the tasks more reasonably. As farming tasks change from one crop to another, and from one season to another, there should be different patterns of rotation.

SOME MORE HINTS

- Find an appropriate speed for the machine that you use. A high machine speed hampers the work quality, causes fatigue and increases the risk of injury. Reduce the speed of machines in order to avoid these negative effects.
- Insert regular short breaks. When tasks are monotonous and machine-paced, more frequent breaks are needed.

POINTS TO REMEMBER

Machine-paced work can be improved by appropriate task rotation and teamwork efforts.

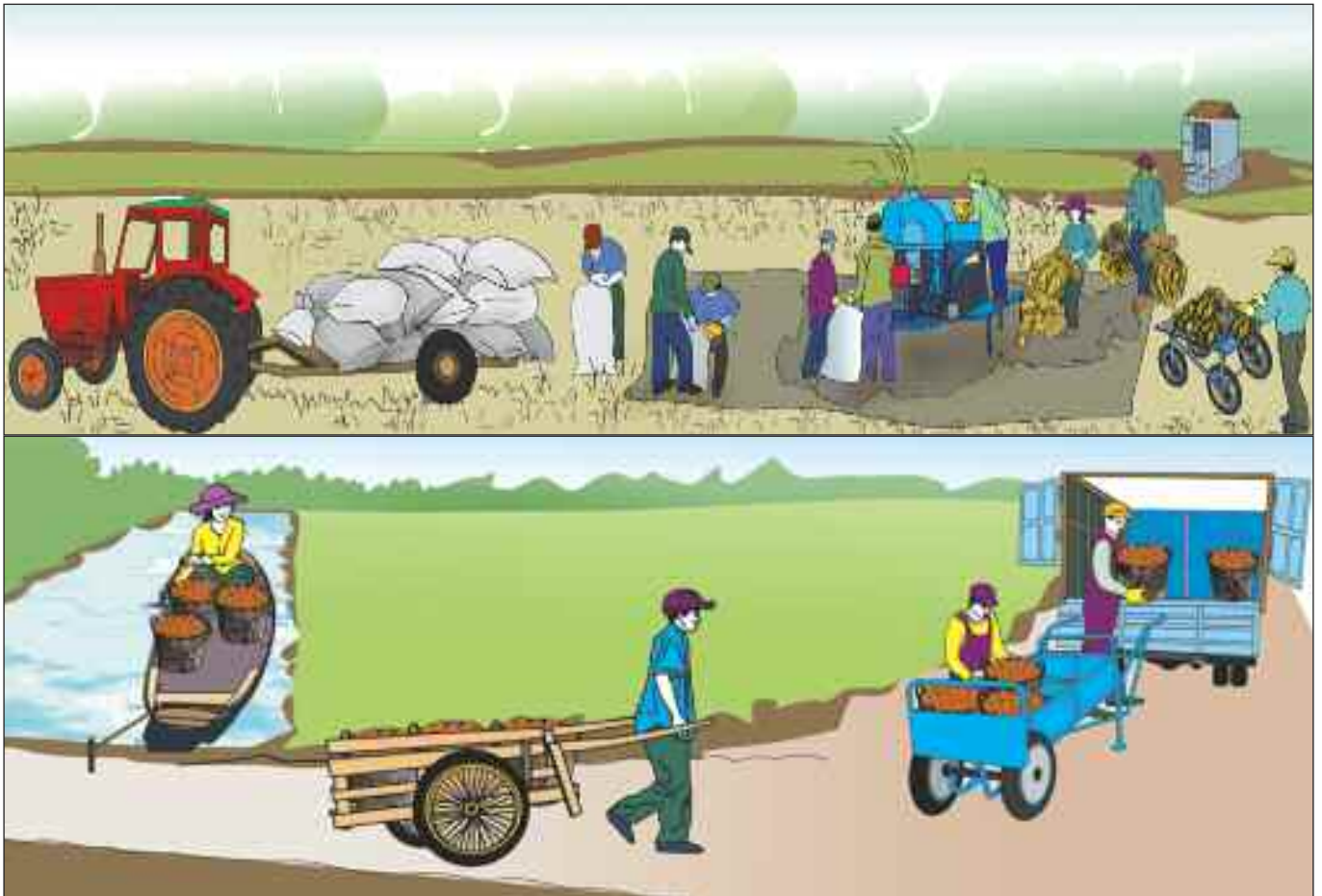

Figure 92. Good teamwork helps you to plan an appropriate rotation of tasks among co-workers. This can reduce monotony and workload, and avoid excessive machine-paced work.

CHECKPOINT 93

Alternate light and heavy work in order to avoid continued heavy and monotonous work.

WHY

Farmers are often engaged in heavy work, such as carrying heavy farm products, or working in hot or cold environments. Continued heavy work can easily cause fatigue and lower productivity. The risks of muscle pains or even injuries will also increase.

Alternating light and heavy work is a practical way to reduce these risks. There should be many lighter tasks in your farm work. Change from heavy work to lighter work from time to time in order to avoid excessive workload. This will contribute to higher productivity, and lower the risks of injury and accident.

HOW

1. Walk around your farm and list the work items that you have to carry out.
2. Classify the work items according to the workload, i.e. heavy or light.
3. Make a practicable plan to alternate light and heavy work.
4. Change the work layout and workflow in order to simplify the planned alternation of heavy and light tasks.
5. Remember that your work tasks will change from season to season. Develop practical work plans.
6. Use appropriate measures to carry out heavy tasks in a safer and easier way. For example, clearer routes, hand-trucks or machine devices will reduce the workload of carrying heavy materials. Apply practical measures to reduce the workload first, and then combine lighter and heavier work items.

WAYS TO PROMOTE COOPERATION

Farmers know which work tasks are heavy. Discuss whether any of these tasks can be done more easily. Identify heavy work tasks that cannot be readily improved, and discuss how to alternate these heavy tasks with lighter ones. If appropriate, make a joint plan to rotate heavy and light work tasks among a group of farmers.

SOME MORE HINTS

- Consider work distance and workflow when developing a workable plan to alternate light and heavy work.
- Promote teamwork efforts to avoid overburdening any one farmer.
- A given work item might be heavier in hot or cold working environments. Consider seasonal changes. Wind, rain or snow will also affect the workload.
- Adapt work procedures to avoid excessive workload.

POINTS TO REMEMBER

Combine heavy and light work items in order to avoid excessive workload and reduce injury risks.



Figure 93. Alternating light and heavy work helps you avoid continued strenuous work.

CHECKPOINT 94

Provide simple and appropriate mechanical devices and tools to reduce manual work.

WHY

Farmers often handle materials and agricultural products manually. The workload is heavy when they have to continue and repeat these tasks. It is important to introduce and use appropriate mechanical devices or tools to reduce this workload.

These devices and tools should be designed to be safe, and easy for farmers to control and operate. They should be simple and strong, since farmers may have to use them in outdoor conditions.

HOW

1. Review the tasks in which you have to handle and carry heavy materials or products frequently.
2. Consult your neighbouring farmers and family members. Ask for their advice on the tasks that need appropriate devices to reduce the workload.
3. Find and use appropriately designed mechanical devices and tools.
4. The devices and tools should be simple, and easy to operate.
5. Where possible, make these devices and tools mobile and strong for outdoor use.

WAYS TO PROMOTE COOPERATION

There are a variety of devices and tools for handling agricultural products. Many of them can reduce the farmers' physical workload and increase productivity. Study the available kinds of device jointly with your neighbours and family members. Visit farmers who are using similar devices and tools, and decide whether it would be useful to introduce them on your own farm. If necessary, also examine a plan for jointly purchasing and maintaining the devices and tools.

SOME MORE HINTS

- Select devices and tools that are safe, and easy to operate.
- Check the devices and tools regularly, and maintain them in a good and safe condition.
- Exchange ideas with your neighbouring farmers to find out which kinds of device and tool would be useful for reducing manual work.

POINTS TO REMEMBER

Simple and easy-to-operate devices can be effective in reducing manual workloads.



Figure 94a. Simple devices can reduce manual workloads.



Figure 94b. A mechanical hoist helps this farmer reduce his workload.

CHECKPOINT 95

Establish a means of emergency contact for farmers working alone in the fields.

WHY

Farmers often work alone on the farm, in crop fields or in vegetable gardens. These places are distant from the community, and there is no one available to provide immediate help when farmers have accidents or other emergency problems.

It is important for farmers to let their family members or neighbouring farmers know where they are working, and when they get back home. A reliable means of emergency contact will facilitate the provision of immediate assistance when an accident happens.

HOW

1. Discuss and develop a safe work plan with your family and neighbouring farmers. Let them know where you will be working, and when you plan to come home.
2. Discuss and establish the means of emergency contact. Written plans are very useful to avoid panic when accidents occur. Let all family members and neighbouring farmers know the plans and measures, and the means of emergency contact.
3. If you have a mobile phone, have it fully charged, and keep it switched on when you are working alone in a remote place. You may need fully charged spare batteries for your mobile phone if you are working in a cold environment, as the low temperature is likely to reduce the batteries' working time.
4. Assess the possible risks when you are working alone in a remote workplace, and readjust your means of emergency contact if necessary.

WAYS TO PROMOTE COOPERATION

Make it a rule to establish daily plans for outdoor work, in consultation with your family members. Include the locations and the finishing time of farming work on each day. Make sure that the plans are known to other members of your family, or some of your neighbours. This rule helps them detect emergencies that may arise while you are working alone in the field.

SOME MORE HINTS

- Develop a plan for bringing injured farmers from a remote workplace to the hospital.
- Special attention is needed if a female farmer needs to work alone in a remote worksite. It is desirable for her to work together with other farmers, and to avoid working alone.
- Elderly farmers also need special attention. They have a higher accident risk because of their weaker eyesight and reduced muscle power. It is better for them to work in a team, and to avoid working alone in a remote work area.
- Farmers should not work alone after dark.

POINTS TO REMEMBER

Develop a written plan for emergency contact for farmers working alone in the field.



Figure 95a. Make arrangements so that a farmer working alone in the field or on the road can be easily recognized by others.



Figure 95b. Establish a means of emergency contact with others working in the field.



Figure 95c. Provide farmers with a means of communicating with others working nearby.

CHECKPOINT 96

Make sure that protective measures and welfare facilities are suitable for migrant farmers.

WHY

Farm work is often done by migrant farmers. This is especially true in busy farm seasons, such as planting or harvesting.

Migrant farmers need special measures to work safely and effectively. In particular, when they come from abroad, or from other regions, they may not understand your language. Work methods and safety measures should be communicated to these migrant workers in a suitable way to ensure their understanding.

HOW

1. Assess the special needs of migrant farmers who help your agricultural work. Find out whether they understand your language, and whether they have any special cultural needs.
2. Learn from experienced farmers who have established good systems for working with migrant farmers in an effective and productive way.
3. Ensure that migrant farmers understand all work-related safety instructions. Prepare essential written instructions in their own language.
4. Make an effort to find out the special cultural needs of migrant farmers, such as foods or religious requirements. Make sure that houses and other facilities provided are fit to their cultural needs.

WAYS TO PROMOTE COOPERATION

Discuss with migrant workers how they feel at work, and what additional measures are needed for them to work safely and comfortably. It is especially important to know whether the existing protective measures are sufficient, and whether existing welfare facilities meet their needs. Take improvement actions in close consultation with the migrant workers.

SOME MORE HINTS

- Have sufficient communication opportunities with migrant workers to ensure their safety and productivity. For example, have a short meeting each morning before starting work.
- Create opportunities to understand their cultural needs. Organize a small party to taste their foods or enjoy their cultural performance.
- Consult local agricultural offices and other agencies, and seek advice to ensure protective measures for migrant workers.

POINTS TO REMEMBER

Migrant farmers need special protection and welfare facilities for safe and productive work.



Figure 96a. Ensure that protective devices meet the special requirements of migrant workers.



Figure 96b. Select protective equipment that meets the needs of each specific job assigned to migrant farmers.

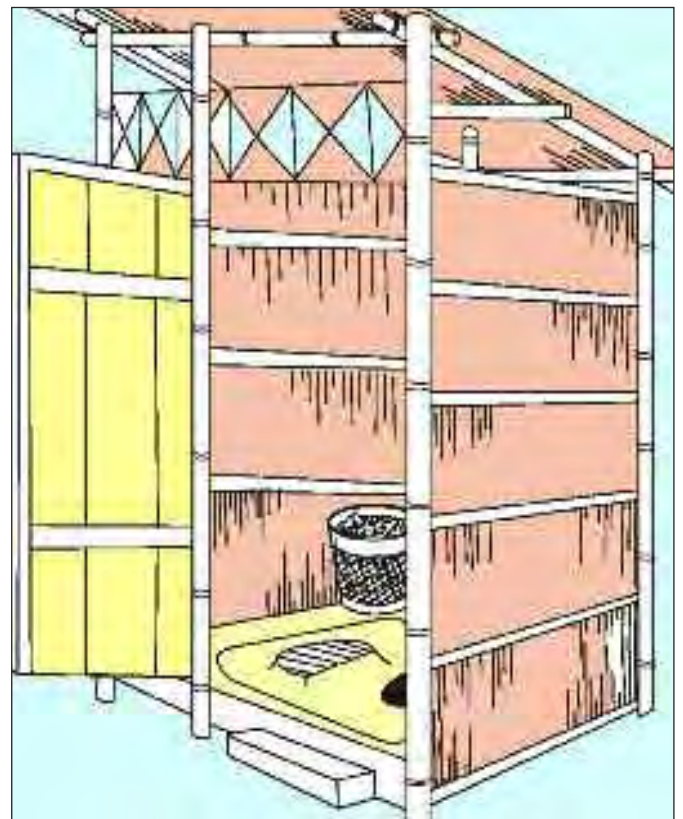

Figure 96c. Provide adequate welfare facilities to migrant workers.

CHECKPOINT 97

Plan annual work schedules, including adequate training periods.

WHY

Farmers' work is affected by seasonal working environments. It is important to establish annual work schedules to realize productive and safe working conditions. It is equally important when developing annual work schedules to ensure the necessary time for family and social activities.

Include a training and study schedule in your annual work plan. Farmers need to upgrade their farming skills for safety, health and efficiency.

HOW

1. Review your work schedule from last year. Analyse the problems that prevented you from working according to the schedule. Consider what could be improved for this year's schedule.
2. List the work items that you need to carry out this year. Also list family and community needs, and your training requirements.
3. Think what kind of training you require in order to upgrade your production skills and safety measures.
4. Develop a written annual work plan together with your family members. Allocate sufficient time to realize your essential needs in work, family life and training.
5. The annual work schedule should incorporate flexibility. You may need to adjust your work plan to meet new or emerging needs. Avoid making a tight schedule that is difficult to complete.

WAYS TO PROMOTE COOPERATION

In planning annual work schedules, take into account family and community events. Discuss with your family members and neighbours whether changes in the schedule are acceptable. Make sure the planned schedule includes sufficient time for holidays, training opportunities and recreational activities.

SOME MORE HINTS

- Include sufficient time for holidays in your work schedule, and ensure adequate time to spend with your family.
- Monitor and review the progress of your work schedule regularly. Discuss with your family whether progress is satisfactory or not. Discuss whether adjustments are needed.
- Include time for study and training on your safety and health. For instance, try to learn the possible health effects of the agrochemicals that you are using. You will find practical solutions to improve the situation.

POINTS TO REMEMBER

Well-planned annual work schedules help farmers ensure safe and productive agricultural work.



Figure 97a. List your work items and family needs.



Figure 97b. Develop annual work schedules for effective work organization.

CHECKPOINT 98

Establish regular working hours; avoid excessively long working days, and insert adequate weekend breaks.

WHY

Because of busy work in agricultural production and on the farm, farmers often don't take time off at weekends. Even on rainy days, many farmers are still working. Weekly breaks help farmers recover from the accumulated fatigue caused by their farm activities. After a break, farmers will be able to work refreshed.

Without regular weekly breaks, there is no time for family get-togethers in a relaxed and friendly atmosphere. Farmers will have less chance of leisure, or of access to useful information in the mass media. It is important to promote a better quality of life as well as the quality of work. The habit of regular breaks should be built among villagers.

HOW

1. Provide regular breaks every week for the whole family. Your family members will use that time for rest and fun.
2. As well as regular weekly breaks, plan to have a longer holiday every year. Sightseeing outside your district would be a wonderful experience for your family, especially the children. Plan and prepare the budget well in advance. Exchange information with neighbours to plan a pleasant holiday period with your family.

WAYS TO PROMOTE COOPERATION

Discuss with your neighbours and community leaders whether you can avoid excessively long hours by rearranging joint activities in busy farming seasons and seasonal community events. Also discuss enhanced cooperation among neighbouring farmers or among different districts so as to secure weekend breaks.

SOME MORE HINTS

- It would be nice if the whole community could promote a culture of taking regular weekly breaks. Create the change gradually, and build a habit for all members in the family to take regular holidays together.
- Exchange experiences with your neighbours, and share steps to have no work on holidays.

POINTS TO REMEMBER

Regular weekly breaks can strengthen your family ties, as well as facilitate recovery from fatigue.

Figure 98a. Establish regular working hours so as to secure time for your daily life activities with your family.



Figure 98b. Spend weekends with your family.

CHECKPOINT 99

Take short breaks at regular intervals, particularly for strenuous work.

WHY

It is very important to insert short breaks during work to recover from fatigue, and to refresh yourself. The breaks can be short (around 15–20 minutes), but need to be frequent, with their frequency depending on the workload. Effective breaks help lead to accident prevention. After a break, work can be done more efficiently.

Working continuously without breaks is dangerous, even if farmers take longer breaks after completing their jobs. Long, continuous work increases feelings of fatigue, and consequently the risk of accidents. Fatigue also decreases the quality of work.

Developing comfortable environments for short breaks is equally important. For farm work, a shady place is needed to increase the effectiveness of breaks. It is essential to provide safe drinking water.

HOW

1. On the farm, select a rest area near the worksite. Farmers should be allowed to take short breaks frequently without losing time. This is especially helpful for farmers whose houses are far from the farm.
2. Each short break can last for around 15–20 minutes, depending on the workload. Take longer breaks for lunch.
3. If possible, build a simple rest facility on the farm. Use locally available low-cost materials near the working area. For instance, install hammocks, mats or simple beds for lying down.

WAYS TO PROMOTE COOPERATION

Neighbours can cooperate to build and implement a habit of short breaks in their community. It is ideal if a rest area could be built jointly for community use. Diligent farmers might feel reluctant to take frequent

breaks. Learn from the good experiences of neighbours who have established the habit of short breaks. They must enjoy better efficiency in their work. Using the rest areas for short breaks consolidates neighbourhood cooperation.

SOME MORE HINTS

- For work done jointly with other farmers, establish work programmes with frequent short breaks. Make sure that all the farmers participating in the work can take short breaks at regular intervals. Get together with your neighbours in the rest area to chat and refresh.
- Use local, low-cost materials to build the rest area. Some farmers may prefer to build a stronger rest house, which can be used also for storing agricultural tools on the farm.

POINTS TO REMEMBER

Frequent short breaks help farmers to recover from fatigue, and to work safely and efficiently.



Figure 99a. Take regular breaks in good conditions in the farming field.



Figure 99b. Strenuous work needs frequent breaks for recovery from fatigue. Establish time plans in advance that include rest breaks.

CHECKPOINT 100

Ensure regular timing of meals, especially during harvesting and other busy periods.

WHY

Farmers need good eating habits to cope with their heavy work requirements. It is essential they ensure sufficient time for regular meals. Have meals with your family. This is a useful habit to maintain good communications with your family members and exchange ideas on your family and work life.

Many farmers face the challenge of maintaining their regular eating habits during harvesting and other busy periods. It is dangerous to work long and hard without taking sufficient meals and rest. Family and neighbourhood cooperation would improve this problem.

HOW

1. Review your eating habits. Take three meals a day regularly.
2. Set a regular timing for your daily three meals. Discuss it with your family members, and try your best to enjoy the meals together.
3. Identify busy periods when your regular eating habits are affected.
4. Make a workable plan to maintain good and regular eating habits for harvesting and other busy seasons. Discuss with your neighbouring farmers possible measures to help each other.
5. Organize training sessions to learn about nutritious meals and proper cooking methods. Also learn about the merits of taking regular meals.

WAYS TO PROMOTE COOPERATION

Exchange information with your neighbouring farmers on how they manage to maintain good eating habits, even during busy work periods. It is useful to discuss good eating habits when participating in community events, or in meetings at which meals are served.

SOME MORE HINTS

- Cook meals together with your family members in order to avoid overburdening a particular family member.
- Prepare meals together with your neighbours during busy work periods. This will be a time-effective way to ensure good eating habits, even in busy seasons.

POINTS TO REMEMBER

Good, regular eating habits support a safe, healthy and productive working life.



Figure 100a. Ensure meal times are regular, even during busy farming seasons.



Figure 100b. Neighbouring farmers can help each other to prepare meals during busy work periods.

Annexes

Annex 1 Using *Ergonomic checkpoints in agriculture* in participatory action-oriented training

Annex 2 Action checklist for agriculture

Annex 3 Sample programmes for a training workshop using *Ergonomic checkpoints in agriculture*

Annex 4 Examples of group work results

Annex 1 Using Ergonomic checkpoints in agriculture in participatory action-oriented training

Interest is growing in many countries in participatory programmes for improving ergonomics and occupational safety and health. Recent experiences show that these programmes result in improvements that can reduce safety and health risks at work in industry and in agriculture. It is encouraging that participatory steps relying on local people's initiative, and focusing on practical improvements, can also lead to concrete results in rural areas and in agriculture.

The participatory ergonomics training programme trains farmers through participatory training methods in a serial manner. These methods comprise farm visits combined with the checklist exercise and group discussions by farmers. Participating farmers complete four main activities in the training programme:

1. they visit a farm or a crop field to conduct the checklist exercise;
2. they attend five technical sessions, which include group discussions;
3. they develop improvement proposals for their own farms; and
4. they implement priority improvements and organize follow-up activities.

A standard training workshop requires two days. A typical two-day programme is shown in Annex 3.

1. Visiting a farm for the checklist exercise

All participants visit a farm or a crop field to conduct the checklist exercise at the beginning of the training. This visit usually comes immediately after the opening session of the workshop. The workshop organizer selects a typical farmer family in the target community for this initial workplace visit. The family should be neither too rich nor too poor, and its farm or crop field should have both good examples and points to be improved in safety and health.

The first activity during the farm visit is the action checklist exercise. Each participant observes the conditions on the farm, and completes the checklist based on his or her own experiences. The checklist items help participants to identify key safety and health

points, and to find corresponding practical solutions. An example of the checklist is shown in Annex 2.

The action checklist exercise encourages participants to learn from the existing good practices of other farmers' work, and to find workable safety and health improvement ideas. Technical presentations by trainers are made only after the checklist exercise. This is to ensure that safety and health activities start with the farmers' own knowledge, rather than waiting for outsiders' assistance, and to promote the farmers' sense of ownership of the subsequent improvement activities.

2. Organizing five technical sessions and group work for prioritizing actions

After returning from the farm visit with their checklists, the participants attend five technical sessions, and discuss both good points and points to be improved on the farm that they have visited. The five technical areas of the training programme are directly related to the farmers' everyday work. In each of these technical areas, there are many low-cost ways to improve safety and health using the farmers' own ideas.

Each of the five technical sessions comprises trainer input, group discussion and group presentation. In trainer input, the trainers show practical guides to improve safety and health in the five technical areas. These guides are to stimulate the farmers' interest in improving safety and health; they are not intended to provide a complete improvement programme. The trainers explain the guides by showing easy-to-understand illustrations and photographs of good local examples to make it easier for participants to understand them. The trainers don't show bad examples, or examples from other countries. Good trainers make the effort to find many good local examples and corresponding photographs for these presentations.

In each technical session, there is a group discussion after the trainer's input. Participants are divided into small groups of five or six farmers. Women and men farmers are normally in the same group. Each group discusses and identifies three good points and three points to be improved in the farm that they have just visited. They are encouraged to discuss the strong points

of the farm first, rather than its weaknesses. Farmers might have many ideas for improvements, but they are advised to prioritize three practical actions that can be implemented using local materials and skills.

3. Developing improvement proposals and organizing follow-up activities

Participating farmers develop proposals to improve safety and health in their own farms and crop fields by referring to the practical guides and the local good examples shown in the five technical sessions. They identify and present three short-term improvements that can be implemented within one month or so, and two long-term improvements that need up to six months to implement.

After conducting the workshop, the trainers visit the farmer participants to follow up their planned improvement actions. The follow-up visits are carried out within a few months after the training. Farmers usually complete the first set of improvements in one to three months after attending the training. They are proud to show their improvements to the trainers. It is important for the trainers to maintain good contact with these farmers to support their long-term safety and health improvement efforts. The initial training workshop is only a start to long-lasting improvement actions by trained farmers.

Regular follow-up visits to the ergonomics training participants provide good opportunities to look at the farmers' improvement actions and discuss further improvement plans. Another effective follow-up action is to organize an achievement workshop where farmers present their improvements, exchange experiences and ideas for further improvements, and discuss collaborative future actions. Ergonomics trainers regularly carry out these follow-up visits and meetings in order to maintain and expand the networks among trained farmers.

Annex 2 Action checklist for agriculture

(From *Practical Hints for the Workplace Checklist*, National Institute of Occupational Safety and Health, Malaysia, 2005)

How to use the checklist

1. Define the work area to be checked.
2. Spend a few minutes walking around the work area.
3. For each action, select NO or YES:
If the action has already been applied or it is not needed, select NO; if you propose the action, select YES.
4. Choose a few urgent actions, and tick PRIORITY for these actions.
5. Put your suggestions under REMARKS.

I. MATERIALS STORAGE AND HANDLING



1. Keep passageways clear and in good condition for the movement of people and materials.

Do you propose action?

NO YES PRIORITY

Remarks



2. Eliminate sudden height differences and holes on transport routes.

Do you propose action?

NO YES PRIORITY

Remarks



3. Construct wide enough and stable bridges over canals or over ditches at the edge of the field or road.

Do you propose action?

NO YES PRIORITY

Remarks



4. Use multi-level shelves or racks near the work area for storing materials, tools or products.

Do you propose action?

NO YES PRIORITY

Remarks



5. Provide containers or baskets of appropriate sizes and with good grips to carry materials and farm products.

Do you propose action?

NO YES PRIORITY

Remarks

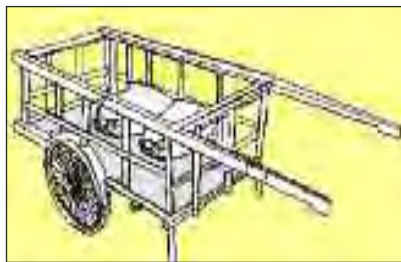

6. Use carts, hand trucks, vehicles, boats or animals to carry heavy materials.

Do you propose action?

NO YES PRIORITY

Remarks



7. Attach large enough wheels to carts and hand trucks to work effectively on field routes.

Do you propose action?

NO YES PRIORITY

Remarks

II. WORKSTATION DESIGN AND WORK TOOLS



8. Adjust the work height so that work is done at elbow level or slightly lower than elbow level.

Do you propose action?

NO YES PRIORITY

Remarks



9. Provide stable chairs or benches with sturdy backrests.

Do you propose action?

NO YES PRIORITY

Remarks



10. Put frequently used tools, switches and materials within easy reach of farmers.

Do you propose action?

NO YES PRIORITY

Remarks

.....



11. Provide a "home" for each tool.

Do you propose action?

NO YES PRIORITY

Remarks

.....



12. Use jigs, clamps or other fixtures to hold items while work is done.

Do you propose action?

NO YES PRIORITY

Remarks

.....

III. MACHINE SAFETY



13. Attach proper guards to dangerous moving parts of machines.

Do you propose action?

NO YES PRIORITY

Remarks

.....



14. Use appropriate feeding devices to avoid danger and increase production.

Do you propose action?

NO YES PRIORITY

Remarks

.....

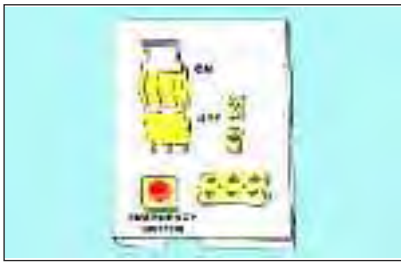

15. Make the emergency controls clearly visible and attach local language labels to the controls or switches.

Do you propose action?

NO YES PRIORITY

Remarks _____

IV. WORK ENVIRONMENT AND CONTROL OF HAZARDOUS AGENTS



16. Increase the use of natural ventilation to improve the indoor climate.

Do you propose action?

NO YES PRIORITY

Remarks _____



17. Use daylight and bright walls for lighting up the workplace.

Do you propose action?

NO YES PRIORITY

Remarks _____



18. Avoid continuous exposure to excessive heat or cold.

Do you propose action?

NO YES PRIORITY

Remarks _____



19. Keep pesticides, agrochemicals and spraying devices in a safe and designated place.

Do you propose action?

NO YES PRIORITY

Remarks _____



20. Put labels on pesticides and agrochemicals.

Do you propose action?

NO YES PRIORITY

Remarks

.....



21. Collect safety and health information, such as the safe use of agrochemicals, and disseminate the information to the community.

Do you propose action?

NO YES PRIORITY

Remarks

.....



22. Be aware of animals, insects or worms that may harm farmers.

Do you propose action?

NO YES PRIORITY

Remarks

.....

V. WELFARE FACILITIES



23. Provide an adequate supply of drinking water and refreshments at the farm.

Do you propose action?

NO YES PRIORITY

Remarks

.....



24. Build clean, hygienic toilets and washing facilities.

Do you propose action?

NO YES PRIORITY

Remarks

.....



25. Provide resting corners and facilities for recovery from fatigue.

Do you propose action?

NO YES PRIORITY

Remarks



26. Use proper protective devices such as clothes, gloves, boots, shoes, hats, helmets to protect from injuries or contact with hazardous substances.

Do you propose action?

NO YES PRIORITY

Remarks



27. Provide first-aid equipment.

Do you propose action?

NO YES PRIORITY

Remarks



28. Take special care of pregnant women and farmers with disabilities.

Do you propose action?

NO YES PRIORITY

Remarks

VI. WORK ORGANIZATION



29. Organize a better work layout to reduce the distance for carrying materials.

Do you propose action?

NO YES PRIORITY

Remarks



30. Insert frequent short breaks.

Do you propose action?

NO YES PRIORITY

Remarks

.....



31. Share family responsibilities to avoid overburdening a particular family member.

Do you propose action?

NO YES PRIORITY

Remarks

.....

Annex 3 Sample programmes for a training workshop using *Ergonomic checkpoints in agriculture*

A. Two-day workshop

Day 1

7.30– 8.00	Registration
8.00– 8.30	Opening ceremony
8.30– 9.00	Orientation to the training
9.00– 9.20	Short break
9.20–11.20	Visits to farms for the action checklist exercise
9.20– 9.50	Transport to workplace
9.50–10.50	Checklist exercise by walk-through
10.50–11.20	Transport back to training venue
11.20–12.00	Group discussion
12.00–13.00	Lunch break
13.00–14.50	Session 1: Materials handling and storage
13.00–13.40	Trainer presentation
13.40–14.20	Group discussion
14.20–14.50	Group presentation and general discussion
14.50–15.10	Short break
15.10–17.00	Session 2: Machine safety
15.10–15.40	Trainer presentation
15.40–16.20	Group discussion
16.20–17.00	Group presentation and general discussion

Day 2

8.00– 9.40	Session 3: Workstations and work tools
8.00– 8.40	Trainer presentation
8.40– 9.10	Group discussion
9.10– 9.40	Group presentation and general discussion
9.40–10.00	Short break
10.00–12.00	Session 4: Work environment and control of hazardous substances
10.00–10.40	Trainer presentation
10.40–11.10	Group discussion
11.10–12.00	Group presentation and general discussion
12.00–13.00	Lunch break
13.00–14.40	Session 5: Welfare facilities
13.00–13.40	Trainer presentation
13.40–14.10	Group discussion
14.10–14.40	Group presentation
14.40–15.00	Short break
15.00–17.00	Session 6: Final proposal development
15.00–15.40	Implementation of improvements
15.40–16.20	Group discussion
16.20–17.00	Group presentation and general discussion

B. One-day workshop

7.00– 7.30	Opening
7.30– 8.00	Orientation to the training
8.00– 9.30	Visiting a farm and a farmer's house for the checklist exercise
9.30– 9.50	Short break
9.50–11.20	Session 1: Improving working conditions
9.50–10.20	Trainer presentation
10.20–10.50	Group discussion
10.50–11.20	Group presentation
11.20–12.30	Lunch break
12.30–14.00	Session 2: Improving living conditions
12.30–13.00	Trainer presentation
13.00–13.30	Group discussion
13.30–14.00	Group presentation
14.00–14.20	Short break
14.20–15.20	Developing an action plan by each farmer family
14.20–14.50	Discussion
14.50–15.20	Presenting action plans
15.20–15.40	Evaluating training programme
15.40–16.00	Closing

Annex 4 Examples of group work results

(From *WIND programme book*, ILO, 2009)

Group work results by farmers in Cantho, Viet Nam

Group	Working conditions	Living conditions
1	<ol style="list-style-type: none"> 1. Wearing shoes when working in the rice field 2. Using long-sleeved shirts to protect farmers against strong sun heat 3. Storing pesticides safely 	<ol style="list-style-type: none"> 1. Developing safety guards for children 2. Planning home economies (incomes and expenses) 3. Buying agro-machines together with neighbours
2	<ol style="list-style-type: none"> 1. Using boats when carrying heavy agricultural products 2. Wearing long-sleeved shirts to protect farmers against strong sun heat 3. Building a rest facility in the rice field 	<ol style="list-style-type: none"> 1. Ensuring food hygiene for children 2. Planning home economies 3. Increasing family communication
3	<ol style="list-style-type: none"> 1. Wearing long-sleeved shirts to protect farmers against strong sun heat 2. Building a rest facility in the rice field 3. Bringing safe drinking water to the rice field 	<ol style="list-style-type: none"> 1. Preparing a family first-aid kit 2. Washing utensils and clothes in a hygienic way 3. Having more openings in the house for better ventilation and lighting
4	<ol style="list-style-type: none"> 1. Building a rest facility in the rice field 2. Bringing safe drinking water to the rice field 3. Constructing a toilet near the rice field 	<ol style="list-style-type: none"> 1. Keeping clothes in a proper and hygienic way 2. Planning home economies 3. Preparing a family first-aid kit
5	<ol style="list-style-type: none"> 1. Constructing a toilet near the rice field 2. Wearing shoes for working in the rice field 3. Storing pesticides safely 	<ol style="list-style-type: none"> 1. Constructing a hygienic toilet 2. Preparing a family first-aid kit 3. Washing utensils and clothes in a hygienic way